

COLUMBIA LIBRARIES OFFSITE

HEALTH SCIENCES STANDARD



HX00036005

Bought of  
P. BLAKISTON, SON & CO.,  
MEDICAL BOOKSELLERS,  
No. 1012 Walnut Street,  
PHILADELPHIA.

RD591

M45

Columbia University  
in the City of New York

College of Physicians and Surgeons



From the Library of

Churchill Carmalt, M. D.

Presented by the Exteruc Club of New York





750

THE SURGERY  
OF  
THE ALIMENTARY CANAL



A TREATISE ON  
THE SURGERY  
OF  
THE ALIMENTARY CANAL

COMPRISING  
THE ŒSOPHAGUS, THE STOMACH,  
THE SMALL AND LARGE INTESTINES,  
AND THE RECTUM

BY  
A. ERNEST MAYLARD, M.B., B.S. (LOND.)

SURGEON TO THE VICTORIA INFIRMARY, GLASGOW  
EXAMINER IN SURGERY TO THE CONJOINT BOARD OF THE ROYAL  
COLLEGES OF PHYSICIANS AND SURGEONS OF EDINBURGH AND THE FACULTY  
OF PHYSICIANS AND SURGEONS OF GLASGOW; LATE EXAMINER IN CLINICAL SURGERY  
TO THE UNIVERSITY OF GLASGOW; FORMERLY EXTRA-HONORARY SURGEON TO  
THE ROYAL HOSPITAL FOR SICK CHILDREN, GLASGOW; AND DISPENSARY  
SURGEON TO THE WESTERN INFIRMARY, GLASGOW; LATE  
DEMONSTRATOR OF ANATOMY, GUY'S HOSPITAL, LONDON



LONDON  
J. & A. CHURCHILL  
7 GREAT MARLBOROUGH STREET

1896



## P R E F A C E

---

THE rapidly growing importance of the treatment by surgery of certain diseases of the œsophagus, stomach, and intestines, and the great advances which have been made along this particular line within the last few years, are sufficiently well known to every surgeon not to require any general introductory remarks. I shall, therefore, limit myself to a brief statement of some of the objects I had in view in endeavouring to embrace under one discussion, subjects which, when treated of at any length, are usually considered separately, and as branches of surgery to be practised by specialists rather than by the general surgeon.

The almost imperceptible differences which exist between the symptoms of disease in one part of the alimentary tract and those of disease in another and distant part, make it difficult in particular cases to refer them to their proper source, and entail upon the surgeon for diagnostic purposes a knowledge of all the regions from which they may spring.

The same argument may be applied, even with greater force, to the subject of operative treatment. Thus, how often does disease in the œsophagus necessitate an operation upon the stomach; and disease in the stomach or rectum call for an operation upon the intestines?

The ambiguity which at present exists in the nomenclature of operations upon the various sections of the alimentary tract, shows how great is the need of some kind of revision, based upon a comprehensive and combined consideration of

Ms. B. 1. 105  
Catherine (Ant. G.)

this particular section of the subject. We find, for instance, similar operations in different parts of the canal described by terms which are etymologically quite different, and, *vice versâ*, terms etymologically alike signifying different operations.

Two methods of dealing with the subject occurred to me. Either I might take certain injuries and diseases, and deal with them as they respectively affected special tracts of the canal; or I might treat the subject purely regionally. The former method offered features of considerable interest from a pathological and etiological aspect; but the latter seemed to afford a better scheme for purely surgical treatment. The chief difficulty, however, in adopting the regional method lay in drawing the line between certain injuries and diseases affecting such regions, for instance, as the jejunum and ileum, and the colon. This difficulty, however, has been surmounted by attempting no such division in certain cases, but combining in one discussion regions where the injuries or diseases produce practically similar symptoms.

The actual portion of the alimentary tract treated extends from the commencement of the œsophagus to the termination of the rectum proper—that is to say, the anal portion of the gut is not included. Hence all diseases affecting the pharynx or throat are excluded, as also those involving the anal portion of the rectum. This latter exclusion involves, therefore, hæmorrhoids, fistula *in ano*, anal fissure, and anal ulcer. Another large class of affection is excluded, the external herniæ.

In order to depict more vividly the particular injury or disease of a region, I have supplemented the text with a case. In a field so extensive, it was not possible to draw exclusively from my own resources; hence when my hospital or private case books failed me, I strove to find from the published records such as seemed best to serve the purpose in view. I attached much importance to these cases, as often being of more interest and instruction than a picture illustration.



With regard to operations, it seemed that, from an essentially practical point of view, it would be better to include all operations upon a particular region in one or more chapters at the conclusion of the discussion of the injuries and diseases of that region. By so doing, there would need to be no reduplication of description when one particular operation is applicable to more than one disease, merely a reference in the text to the operation would suffice. The only exceptions to this division are in the case of special operation for special cases, as for instance the various operations in vogue for the treatment of prolapse of the rectum, operations which bear the name of a particular surgeon and are only applicable to particular cases. These, and others like them, which cannot be exactly termed classical operations, are introduced in the treatment of the subject to which they specially apply.

Many of the figures introduced to illustrate injuries or diseases have been taken from among the extensive and valuable collection of specimens contained in the Pathological Museums respectively of the Western, Royal, and Victoria Infirmaries, and from the Hunterian of the University of Glasgow. For permission to make use of these I am indebted to Professor JOSEPH COATS, Dr. CHARLES WORKMAN, Dr. T. K. MONRO, and Professor JOHN YOUNG. With the exception of the skiagraph kindly given me by Dr. JOHN MACINTYRE, all the Plates are from photographs taken by my Assistant Colleague at the Victoria Infirmary, Dr. J. GRANT ANDREW, to whom I am indebted not only for this important feature in the work, but for the arduous labour of making the index.

The proofs have passed through the careful hands of Dr. HENRY RUTHERFURD, to whom I am also under an obligation for many valuable suggestions in the course of the work.

I cannot conclude without acknowledging the assistance I have derived from the valuable work upon 'Diseases of the Throat and Nose' by the late Sir MORELL MACKENZIE, whose experience in affections of the œsophagus was exceptionally

extensive. To Mr. FREDERICK TREVES, of London, I must also acknowledge my indebtedness. His work and numerous writings have done much to advance the subject of gastrointestinal surgery in this country.

Lastly, I wish to express of what inestimable service the two American publications—the ‘Index Medicus’ and the ‘Annual of the Universal Medical Sciences’—have been in enabling me to accomplish that particular and important constituent of the work comprised in the acquisition of requisite references.

10 BLYTHEWOOD SQUARE, GLASGOW.

*October 22 1896.*

# CONTENTS

## PART I

### THE ŒSOPHAGUS

CHAPTER	PAGE
I. SURGICAL ANATOMY AND PHYSIOLOGY . . . . .	1
II. INJURIES. INTERNAL AND EXTERNAL INJURY. RUPTURE . . . . .	4
III. IMPACTION OF FOREIGN BODIES: NATURE OF BODY IMPACTED: SEAT OF IMPACTION. SYMPTOMS, DIAGNOSIS, PROGNOSIS, TREATMENT . . . . .	16
IV. INFLAMMATORY AFFECTIONS: ACUTE TRAUMATIC ŒSOPHAGITIS; ACUTE IDIOPATHIC ŒSOPHAGITIS; ŒSOPHAGITIS OF CHILDREN; MEMBRANOUS OR PELLICULAR ŒSOPHAGITIS; APHTHOUS ŒSOPHAGITIS; CHRONIC ŒSOPHAGITIS; PHLEGMONOUS ŒSOPHAGITIS; SUBMUCOUS ŒSOPHAGEAL ABSCESSSES; CATARRHAL ŒSOPHAGITIS; FOLLICULAR ŒSOPHAGITIS; CROUPOUS ŒSOPHAGITIS . . . . .	36
V. ULCER. VARICOSE VEINS. SYPHILIS. TUBERCULOSIS . . . . .	46
VI. TUMOURS: INNOCENT—PAPILLOMA. CYSTS. FIBROMA. ADENOMA. MYXOMA. MYOMA. LIPOMA . . . . .	54
VII. TUMOURS: MALIGNANT—CARCINOMA AND SARCOMA . . . . .	58
VIII. CARCINOMA ( <i>continued</i> ). PROGNOSIS AND TREATMENT . . . . .	72
IX. NON-MALIGNANT OR CICATRICAL STRICTURE. ETIOLOGY. SYMPTOMS, DIFFERENTIAL DIAGNOSIS, DIAGNOSIS, PROGNOSIS . . . . .	84
X. CICATRICAL STRICTURE ( <i>continued</i> ). TREATMENT . . . . .	93
XI. PARALYSIS AND SPASM. ETIOLOGY, SYMPTOMS, DIAGNOSIS, PROGNOSIS, TREATMENT . . . . .	103
XII. ABNORMALITIES: DILATATION. DIVERTICULA. CONGENITAL ATRESIA. CONGENITAL STENOSIS. TORSION . . . . .	112
XIII. ABNORMALITIES ( <i>continued</i> ). DIVERTICULA. ETIOLOGY, PATHOLOGY, SYMPTOMS, DIAGNOSIS, PROGNOSIS, TREATMENT . . . . .	117

CHAPTER	PAGE
XIV. ABNORMALITIES ( <i>continued</i> ). MALFORMATIONS OR DEFORMITIES. CONGENITAL ATRESIA. CONGENITAL STENOSIS. TORSION .	125
XV. EXTERNAL INFLUENCES: PRESSURE. PERFORATION. DISTORTION	130
XVI. OPERATIONS: 1. INTRODUCTION OF BOUGIES, FORCEPS. PRO- BANGS, EXTRACTORS, &C. 2. INTERNAL ŒSOPHAGOTOMY. 3. ELECTROLYSIS. 4. EXTERNAL ŒSOPHAGOTOMY (CER- VICAL). 5. EXTERNAL ŒSOPHAGOTOMY (THORACIC). 6. ŒSO- PHAGOSTOMY. 7. EXCISION OF DIVERTICULA. 8. ŒSOPHAGO- PLASTY. 9. ŒSOPHAGECTOMY . . . . .	134

---

PART II  
*THE STOMACH*

XVII. SURGICAL ANATOMY AND PHYSIOLOGY . . . . .	145
XVIII. METHODS (1) OF OBTAINING GASTRIC JUICE FOR EXAMINA- TION: (2) FOR DETECTION OF FREE HYDROCHLORIC ACID: (3) OF ASCERTAINING THE RATE OF GASTRIC ABSORPTION: (4) FOR DETERMINING THE MOTOR POWER OF THE STOMACH. PHYSICAL EXAMINATION: PALPATION; PERCUSSION; AUSCULTATION; INFLATION; GASTROSCOPY; GASTRO-DIA- PHANY . . . . .	149
XIX. INJURIES: CONTUSION, TRAUMATIC RUPTURE, TRAUMATIC PERFORATION, GUNSHOT WOUND . . . . .	156
XX. FOREIGN BODIES. GASTROLITHS. HAIR CONCRETIONS . . . . .	164
XXI. DISEASE. EXPLORATORY GASTROTOMY. ULCER: ITS CHA- RACTER, AND OCCURRENCE OF EXCESSIVE HÆMORRHAGE . . . . .	173
XXII. ULCER ( <i>continued</i> ): PERFORATION: ITS TREATMENT BY (1) EX- CISION OF THE PERFORATED ULCER: (2) BY SIMPLE SUTURE OF THE PERFORATION: (3) BY STITCHING THE SEAT OF PERFORATION TO THE ABDOMINAL INCISION: (4) BY OPEN DRAINAGE. TABLE OF CASES SUCCESSFULLY TREATED BY OPERATION . . . . .	181
XXIII. ULCER ( <i>continued</i> ): FORMATION OF ABSCESS; FISTULOUS COM- MUNICATIONS; EXTERNAL ADHESIONS; INTERNAL CONTRAC- TION; PYLORIC STENOSIS . . . . .	192
XXIV. TUMOURS IN THE BODY OF THE STOMACH: INNOCENT; MALIGNANT . . . . .	201
XXV. OBSTRUCTION AT THE CARDIAC AND PYLORIC ORIFICES . . . . .	207
XXVI. PYLORIC OBSTRUCTION. TREATMENT ( <i>continued</i> ). PROGNOSIS IN RESPECT TO THE OPERATIONS OF PYLORECTOMY: GASTRO- ENTEROSTOMY: THE COMBINED OPERATION OF PYLORECTOMY AND GASTRO-ENTEROSTOMY: DIGITAL DIVULSION: PYLORO- PLASTY: DUODENOSTOMY: JEJUNOSTOMY; AND CURETTING	218

CHAPTER	PAGE
XXVII. GASTRIC DILATATION. CONDITIONS DEPENDENT UPON EXTERNAL INFLUENCES SUCH AS ADHESIONS, TUMOURS, AND SYSTEMIC DISEASES . . . . .	224
XXVIII. OPERATIONS: 1. LAVAGE. 2. ASPIRATION. 3. GASTROTOMY. 4. GASTROSTOMY: EGBERT'S; HAHN'S; WITZEL'S; FRANKS'S. 5. GASTRECTOMY. 6. GASTRORRHAPHY. 7. GASTROPEXY . . . . .	228
XXIX. OPERATIONS ( <i>continued</i> ): 8. GASTRO-ENTEROSTOMY (GASTRO-JEJUNOSTOMY, GASTRO-ILEOSTOMY, GASTRO-COLOSTOMY): WÜLFER'S; SENN'S. SOURCE OF FAILURE AND TRIBLE-SOME AFTER EFFECTS . . . . .	248
XXX. OPERATIONS ( <i>continued</i> ): 9. PYLORECTOMY. 10. PYLOROPLASTY (HEINEKE-MIKULICZ). 11. PYLORIC DIVULSION. (LORETA). 12. CURETTING (BERNAYS) . . . . .	260

## PART III

### THE SMALL AND LARGE INTESTINE

#### SECTION I

##### THE DUODENUM

XXXI. ANATOMY. INJURIES: RUPTURE; FOREIGN BODIES . . . . .	271
XXXII. DISEASE. SIMPLE OR CHRONIC ULCER. ACUTE ULCERATION . . . . .	277
XXXIII. TUMOURS: INNOCENT AND MALIGNANT. STRICTURE. CONGENITAL STENOSIS AND OBLITERATION. PERFORATION FROM EXTERNAL CAUSES . . . . .	288
XXXIV. OPERATIONS: DUODENOSTOMY. DUODENECTOMY. DUODENOTOMY. DUODENOPLASTY . . . . .	295

#### SECTION II

##### THE JEJUNUM AND ILEUM

XXXV. ANATOMY AND PHYSIOLOGY . . . . .	297
XXXVI. INJURIES. CONTUSION: ACUTE AND CHRONIC ENTERITIS, ULCERATION AND SLOUGHING, STRICTURE. RUPTURE . . . . .	300
XXXVII. INJURIES ( <i>continued</i> ). PUNCTURED AND INCISED WOUNDS. NATURE OF LESION. SYMPTOMS, PROGNOSIS, TREATMENT . . . . .	313
XXXVIII. INJURIES ( <i>continued</i> ). GUN- AND PISTOL-SHOT WOUNDS. NATURE OF LESION. SYMPTOMS, PROGNOSIS, TREATMENT . . . . .	319
XXXIX. FOREIGN BODIES: THEIR NATURE, AND COURSE TAKEN IN PROCESS OF NATURAL EXPULSION. SYMPTOMS, TREATMENT . . . . .	328

CHAPTER	PAGE
XL. TUBERCULAR ULCERATION: SYMPTOMS AND TREATMENT. TYPHOID ULCERATION: SYMPTOMS AND TREATMENT. OPERATION . . . . .	339
LI. OBSTRUCTION. INTERNAL HERNIA (A) INTO NORMAL PERI- TONEAL FOSSÆ. (B) STRANGULATION THROUGH ADVENTI- TIOUS OR CONGENITAL APERTURES . . . . .	349
XLII. OBSTRUCTION ( <i>continued</i> ). INTERNAL HERNIA ( <i>continued</i> ) (C) UNDER BANDS, CORDS, AND DIVERTICULA. STRANGU- LATION PRODUCED BY NORMAL STRUCTURES, AS THE VERMI- FORM APPENDIX, THE APPENDICES EPIPLOICÆ, AND THE FALLOPIAN TUBE. METHOD BY WHICH STRANGULATION BENEATH A BAND IS EFFECTED. SYMPTOMS, DIAGNOSIS, TREATMENT . . . . .	354
XLIII. OBSTRUCTION ( <i>continued</i> ). ADHESIONS. KINKING. SYMPTOMS AND TREATMENT . . . . .	368
XLIV. OBSTRUCTION ( <i>continued</i> ). INTUSSUSCEPTION. PATHO- LOGICAL ANATOMY: THE ILEO-CÆCAL, ENTERIC, AND ILEO- COLIC VARIETIES. THE INDIRECT AND DIRECT CAUSES OF OBSTRUCTION. SYMPTOMS . . . . .	371
XLV. OBSTRUCTION ( <i>continued</i> ). INTUSSUSCEPTION ( <i>continued</i> ). TREATMENT: I. OF ACUTE CASES SEEN WITHIN FORTY- EIGHT HOURS; II. OF ACUTE CASES NOT SEEN TILL AFTER FORTY-EIGHT HOURS; III. OF SUBACUTE CASES; IV. OF CHRONIC CASES . . . . .	382
XLVI. OBSTRUCTION ( <i>continued</i> ). VOLVULUS. SYMPTOMS AND TREATMENT . . . . .	389
XLVII. OBSTRUCTION ( <i>continued</i> ). STRICTURE: ITS NATURE AND PATHOLOGICAL SEQUELS. SYMPTOMS. TREATMENT . . . . .	393
XLVIII. OBSTRUCTION ( <i>continued</i> ). GALL-STONES. SYMPTOMS, PRO- GNOSIS, TREATMENT, OPERATION. INTESTINAL CONCRE- TIONS OR ENTEROLITHS . . . . .	401
XLIX. TUMOURS OF THE BOWEL WALL. INNOCENT: FIBROMA, MYOMA, ADENOMA, LIPOMA, CYSTS. MALIGNANT: CAR- CINOMA: SYMPTOMS AND TREATMENT. SARCOMA: SYM- PTOMS AND TREATMENT . . . . .	410
L. EXTERNAL PRESSURE. PERITONITIS, ENTERITIS. CONGENITAL ABNORMALITIES, MALDEVELOPMENTS. NEUROSES . . . . .	417

## SECTION III

## THE LARGE INTESTINE AND APPENDIX VERMIFORMIS

LI. ANATOMY AND PHYSIOLOGY . . . . .	425
LII. INJURIES. INFLAMMATION. ULCERATION: TYPHOID ULCER, TUBERCULAR ULCER, DYSENTERIC ULCER, GENERAL	

CHAPTER	PAGE
ULCERATIVE COLITIS, ULCER FROM OBSTRUCTION, STERCORAL ULCERS, ULCERS FOLLOWING UPON LESION OF THE SPINAL CORD, SYPHILITIC ULCERS, CATARRHAL ULCERS . . . . .	430
LIII. NON-MALIGNANT OR CICATRICAL STRICTURE. SYMPTOMS, DIAGNOSIS, TREATMENT . . . . .	438
LIV. INTERNAL STRANGULATION: DIAPHRAGMATIC HERNIA. ADHESIONS. KINKING. INTUSSUSCEPTION. SYMPTOMS, DIAGNOSIS, PROGNOSIS, AND TREATMENT. VOLVULUS: SYMPTOMS AND TREATMENT . . . . .	444
LV. GALL-STONES, ENTEROLITHS: SYMPTOMS. FÆCAL ACCUMULATION: SYMPTOMS AND TREATMENT . . . . .	453
LVI. TUMOURS: INNOCENT: PAPILOMA AND ADENOMA, FIBROMA AND FIBRO-MYOMA, LIPOMA, DERMoids, CYSTS. MALIGNANT: CARCINOMA: PATHOLOGY AND SYMPTOMS . . . . .	461
LVII. CARCINOMA ( <i>continued</i> ). DIAGNOSIS, PROGNOSIS, TREATMENT. SARCOMA . . . . .	471
LVIII. IDIOPATHIC DILATATION: TREATMENT. ABNORMALITIES: MISPLACEMENTS: 1. OF THE WHOLE BOWEL; 2. OF THE CÆCUM; 3. OF THE SIGMOID FLEXURE. MALDEVELOPMENT. ABNORMALITIES OF THE ILEO-CÆCAL VALVE . . . . .	477
LIX. EMBOLISM AND THROMBOSIS OF THE MESENTERIC VESSELS: SYMPTOMS. THROMBOSIS OF THE SUPERIOR MESENTERIC VEIN . . . . .	486
LX. THE VERMIFORM APPENDIX: ANATOMY. APPENDICITIS: PATHOLOGY AND ETIOLOGY . . . . .	489
LXI. APPENDICITIS ( <i>continued</i> ): SYMPTOMS AND DIAGNOSIS . . . . .	497
LXII. APPENDICITIS ( <i>continued</i> ): PROGNOSIS REGARDING THE DISEASE, AND REGARDING OPERATION. TREATMENT . . . . .	506
LXIII. APPENDICITIS ( <i>continued</i> ). OPERATION: IN CASES OF 1. ABSCESS; 2. FISTULÆ; 3. ADHESIONS OF THE APPENDIX WITHOUT AN EXUDATION; 4. ADHESIONS WITH AN EXUDATION; 5. PERFORATION AND PERITONITIS. OTHER DISEASES OF THE APPENDIX: CYSTS, MALIGNANT DISEASE . . . . .	513
LXIV. OPERATIONS UPON THE SMALL AND LARGE INTESTINE. TERMINOLOGY. LIST OF OPERATIONS. ENTEROTOMY. ENTEROSTOMY: NÉLATON'S OPERATION. JEJUNOSTOMY: JESSETT'S MODIFICATION, MAYDL'S MODIFICATION, ALBERT'S MODIFICATION. ILEOSTOMY . . . . .	518
LXV. OPERATIONS ( <i>continued</i> ): ENTERECTOMY. ENTERO-ANASTOMOSIS: 1. END-TO-END UNION; 2. LATERAL APPROXIMATION; 3. LATERAL IMPLANTATION. METHODS OF UNITING BOWEL: A. UNION BY SUTURE: 1. THE CIRCULAR, ( <i>a</i> ) THE CZERNY-LEMBERT, ( <i>b</i> ) BISHOP'S SUTURE; 2. ABBE'S	

	SUTURE ; 3. MAUNSELL'S SUTURE ; 4. HALSTED'S SUTURE. B. UNION BY PLATES : SENN'S METHOD. C. UNION BY TUBES : PAUL'S METHOD ; ROBINSON'S METHOD. D. UNION BY BONE BOBBINS : ROBSON'S METHOD. E. UNION BY METAL BUTTONS : MURPHY'S METHOD. F. UNION BY RINGS : ABBE'S METHOD. G. OTHER METHODS OF UNION, BY CLAMPS . . . . .	526
LXVI.	OPERATIONS ( <i>continued</i> ) : ENTERO-ENTEROSTOMY (SHORT-CIRCUITING). ENTEROPLASTY. COLOTOMY. COLOSTOMY : LUMBAR, INGUINAL, SIGMOIDOSTOMY. COLECTOMY : PAUL'S METHOD. BARACZ'S OPERATION. COLOPEXY . . . . .	543
LXVII.	OPERATIONS ( <i>continued</i> ) : ARTIFICIAL ANUS ; SIGMOID ANUS. CRIPPS'S OPERATION. LUMBAR ANUS. CLOSURE OF FÆCAL FISTULA AND ARTIFICIAL ANUS : CHAPUT'S OPERATION . . . . .	550
LXVIII.	OPERATIONS ( <i>continued</i> ) : APPENDICECTOMY : THE SKIN INCISION ; TO FIND THE APPENDIX ; TO REMOVE THE APPENDIX : TREVES'S METHOD, BARKER'S METHOD. OTHER OPERATIONS INVOLVING SOME PART OF THE BOWEL : GASTRO-ENTEROSTOMY ; CHOLECYST-ENTEROSTOMY ; URETERO-ENTEROSTOMY ; CYST-ENTEROSTOMY . . . . .	556

## PART IV

### THE RECTUM

LXIX.	ANATOMY AND PHYSIOLOGY. SURGICAL ANATOMY. METHODS OF EXAMINATION . . . . .	561
LXX.	INJURIES. NATURE AND RESULTS OF INJURY. SYMPTOMS, TREATMENT. FOREIGN BODIES. FÆCAL CONCRETIONS. SYMPTOMS, DIAGNOSIS, PROGNOSIS, TREATMENT . . . . .	567
LXXI.	DISEASE. INFLAMMATION : PROCTITIS : SYMPTOMS AND TREATMENT. PERIPROCTITIS. NON-MALIGNANT ULCERATION : DYSENTERIC ULCERATION, TUBERCULAR ULCERATION, SYPHILITIC ULCERATION, VARICOSE ULCER, ULCERATION FROM OTHER CAUSES. SYMPTOMS AND TREATMENT . . . . .	577
LXXII.	NON-MALIGNANT OR CICATRICAL STRICTURE : PATHOLOGICAL SEQUENCES. SYMPTOMS, DIAGNOSIS, PROGNOSIS, TREATMENT 1. BY BOUGIES ; 2. BY ELECTROLYSIS ; 3. BY INTERNAL PROCTOTOMY ; 4. BY EXTERNAL OR LINEAR PROCTOTOMY ; 5. BY EXCISION ; 6. BY ARTIFICIAL ANUS . . . . .	590
LXXIII.	TUMOURS : INNOCENT : POLYPUS. ADENOMA, FIBROMA, PAPILLOMA, LYMPHOMA, MYOMA, MYXOMA, LIPOMA, CYSTOMA, TERATOMA, ANGEIOMA. SYMPTOMS, DIAGNOSIS, PROGNOSIS, TREATMENT . . . . .	601



CHAPTER	PAGE
LXXIV. TUMOURS ( <i>continued</i> ): MALIGNANT: CARCINOMA: PATHOLOGY, PROGRESS OF THE DISEASE . . . . .	612
LXXV. CARCINOMA ( <i>continued</i> ): SYMPTOMS. DIAGNOSIS. PROGNOSIS IN REGARD TO THE OPERATION: 1. OF EXCISION THROUGH THE PERINEUM; 2. OF EXCISION THROUGH THE SACRUM; 3. OF THE FORMATION OF AN ARTIFICIAL ANUS . . . . .	619
LXXVI. CARCINOMA ( <i>continued</i> ): TREATMENT: 1. OF NON-OPERABLE CASES; 2. OF OPERABLE CASES. SARCOMA . . . . .	631
LXXVII. PROLAPSE: ETIOLOGY, SYMPTOMS, TREATMENT IN CHILDREN	637
LXXVIII. PROLAPSE ( <i>continued</i> ): TREATMENT IN ADULTS: 1. BY CLAMP AND CAUTERY; 2. BY CAUTERY; 3. BY ELLIPTICAL INCISIONS: ROBERTS'S OPERATION; 4. BY AMPUTATION: (A) MIKULICZ'S METHOD, (B) TREVES'S METHOD, (C) KLEBERG'S METHOD; 5. BY ELEVATION AND FIXATION: (A) VERNEUIL'S METHOD, (B) M'LEOD'S METHOD, (C) BY PRELIMINARY LAPAROTOMY. LANGE'S METHOD. INTUSUSCEPTION. RECTAL HERNIA. RECTOCELE . . . . .	642
LXXIX. MALFORMATIONS: PATHOLOGY, SYMPTOMS, DIAGNOSIS, PROGNOSIS IN REGARD TO THE DISEASE, AND TO OPERATION . . . . .	654
LXXX. MALFORMATIONS ( <i>continued</i> ): TREATMENT. CONGENITAL STRICTURE. DIVERTICULUM . . . . .	664
LXXXI. NEUROSES. EXTERNAL INFLUENCES PRODUCING PRESSURE, DISPLACEMENT OR DISTORTION, AND PERFORATION . . . . .	672
LXXXII. OPERATIONS. THE ADMINISTRATION OF COPIOUS FLUID ENEMATA. THE PASSAGE OF BOUGIES &C.; INTERNAL PROCTOTOMY. EXTERNAL PROCTOTOMY. PROCTECTOMY: PERINEAL . . . . .	676
LXXXIII. OPERATIONS ( <i>continued</i> ): SACRAL PROCTECTOMY. KRASKE'S OPERATION. MODIFICATIONS INTRODUCED BY HEINEKE, KOCHER, LEVY, HEGAR, REHN (REHN-RYDYGIER), BORELIUS. PARA-SACRAL METHOD (ZUCKERKANDL AND WÖFLER). METHODS OF TREATING THE BOWEL AFTER EXCISION TO OBTAIN SPHINCTER ACTION, BY LANGE, WILLEMS, WITZEL, GERSUNY. AFTER TREATMENT. VAGINAL PROCTECTOMY. METHODS FOR HIGH REMOVAL OF DISEASE, BY MAUNSELL'S SUTURE, BY UHLMANN, BY BACON. PROCTORRHAPHY. PROCTOPEXY. PROCTOPLASTY. RECTAL ELECTROLYSIS. RECTAL CAUTERISATION . . . . .	683
LXXXIV. RECTAL ADMINISTRATIONS. NUTRITIVE ENEMATA: VARIOUS KINDS AND MODE OF ADMINISTRATION. THERAPEUTIC ENEMATA: PURGATIVE, ANTHELMINTIC, ASTRINGENT, SEDATIVE . . . . .	693
INDEX OF NAMES . . . . .	699
INDEX OF SUBJECTS . . . . .	707

## LIST OF CASE REPORTS

### ŒSOPHAGUS

NO. OF CASE	PAGE
I. A diffuse periœsophageal abscess in a 'sword swallower' .	6
II. Rupture produced by vomiting . . . . .	10
III. Rupture during a violent endeavour to dislodge an impacted mass of food. Death from exhaustion in seven and a half days . . . . .	11
IV. Rupture during vomiting after a heavy meal. Death in seven hours . . . . .	12
V. Rupture: softening of the walls by gastric solution just prior to death . . . . .	12
VI. Rupture where the walls had become softened by gastric solution . . . . .	13
VII. Coin impacted: symptoms not urgent at first, but developing later . . . . .	19
VIII. Impaction of a piece of meat. Death from dyspnœa caused by abscess . . . . .	20
IX. Perforation by a fish bone. Post-œsophageal abscess, and death from pyæmia . . . . .	21
X. Impaction of a mass of meat, and perforation by a piece of bone. Extensive emphysema and death . . . . .	21
XI. Perforation of the aorta by a piece of impacted bone. Death from hæmorrhage . . . . .	22
XII. Perforation by an impacted fish bone. Death from injury to the heart . . . . .	22
XIII. Impaction of a fish bone: perforation of an intervertebral substance and injury to the spinal cord . . . . .	23
XIV. Impaction of a coin: expulsion by the mouth after four months . . . . .	26
XV. Impaction of a toothplate: expulsion by the mouth after fifteen months . . . . .	26
XVI. Impaction of a toothplate: expulsion <i>per anum</i> five months afterwards . . . . .	27
XVII. Impaction of a five-centime piece. Death from scarlet fever twenty months afterwards. Coin found partially encysted . . . . .	27

NO. OF CASE		PAGE
XVIII.	Impaction of a chestnut. Death from acute phthisis fourteen months afterwards. Chestnut found encysted	27
XIX.	Impaction of a piece of bone : ejection of the bone by induction of vomiting . . . . .	29
XX.	Impaction of the heart of a bird : subcutaneous injection of $\frac{1}{2}$ grain of tartar emetic : ejection of the substance by vomiting . . . . .	30
XXI.	Impaction of a piece of bone : subcutaneous injection of $\frac{1}{20}$ grain of apomorphia : ejection of the bone by vomiting . . . . .	30
XXII.	Rupture of the aorta, the result of an endeavour to force onwards, by means of a probang, an impacted tooth-plate . . . . .	32
XXIII.	Extraction of an impacted fish hook . . . . .	34
XXIV.	Impaction of a peach stone : successful removal through the mouth by the aid of gastrotomy . . . . .	36
XXV.	Impaction of false teeth : successful removal through the mouth by the aid of gastrotomy . . . . .	36
XXVI.	Acute œsophagitis the result of a sting of a wasp. Recovery in nine days . . . . .	38
XXVII.	Acute idiopathic œsophagitis . . . . .	40
XXVIII.	Æsophagitis in a child . . . . .	41
XXIX.	Diphtheritic œsophagitis . . . . .	42
XXX.	Chronic œsophagitis . . . . .	45
XXXI.	Simple ulcer leading to stricture . . . . .	48
XXXII.	Varix. Death from hæmorrhage . . . . .	51
XXXIII.	Fatal hæmorrhage from varicose veins . . . . .	51
XXXIV.	Polypus . . . . .	57
XXXV.	Carcinoma : gastrostomy : survival for 407 days . . . . .	82
XXXVI.	Syphilitic stenosis . . . . .	88
XXXVII.	Forceful dilatation of cicatricial stricture with bougies	96
XXXVIII.	Cicatricial stricture treated by gastrostomy, and subsequent dilatation with bougies . . . . .	103
XXXIX.	Spasm due to gout . . . . .	111
XL.	Dilatation supervening upon a fall . . . . .	116
XLI.	Pressure diverticulum situated in the neck . . . . .	125
XLII.	Congenital atresia . . . . .	128
XLIII.	Congenital atresia . . . . .	128
XLIV.	Congenital stricture . . . . .	129

#### STOMACH

XLV.	Rupture of the stomach and spleen. Death . . . . .	161
XLVI.	Pistol-shot wound : suture of wounds. Recovery . . . . .	164
XLVII.	The existence of a razor in the stomach. Gastrostomy. Death from hæmophilia . . . . .	171
XLVIII.	Exploratory gastrostomy for supposed ulcer : nothing found, but patient completely restored to health . . . . .	174

xviii SURGERY OF THE ALIMENTARY CANAL

NO. OF CASE		PAGE
XLIX.	Exploratory gastrotomy for supposed disease: nothing found, but patient completely restored to health . . .	175
L.	Perforation of gastric ulcer: laparotomy: suture of perforation. Recovery . . . . .	190
LI.	Perforation of gastric ulcer: laparotomy and fixation of the gastric opening to the edge of the parietal incision. Death on the sixth day . . . . .	191
LII.	Gastric ulcer with formation of subphrenic abscess: operation. Recovery. Death subsequently from septi-cæmia . . . . .	195
LIII.	Gastric ulcer with gastro-colic sinus . . . . .	197
LIV.	Carcinoma of pylorus: gastro-enterostomy. Death on the ninth day from inanition the result of a gastric fistula . . . . .	211
LV.	Carcinoma of pylorus: gastro-enterostomy. Death on the fourth day from uræmia . . . . .	211

*DUODENUM*

LVI.	Traumatic rupture of the third part of the duodenum . . .	276
LVII.	Simple ulcer. Death from perforation . . . . .	281
LVIII.	Simple ulcer: no symptoms until perforation . . . . .	282
LIX.	Ulceration after a burn . . . . .	288

*JEJUNUM AND ILEUM*

LX.	Acute obstruction from cicatricial contraction of the bowel following upon injury . . . . .	301
LXI.	Ulceration and perforation above a traumatic stricture of the jejunum . . . . .	302
LXII.	Rupture of the jejunum at its middle. Death in twenty-eight hours . . . . .	309
LXIII.	Stab wound of the abdomen, with multiple wounds of the intestine: laparotomy: intestinal suture. Recovery . . . . .	318
LXIV.	Pistol-shot wound of the small intestine: seven perforations: suture. Recovery . . . . .	327
LXV.	Revolver-shot wound of the intestine and mesentery: five perforations: suture. Recovery . . . . .	328
LXVI.	Perforation of the bowel by a crown of a species of spear grass: acute peritonitis. Death . . . . .	332
LXVII.	Perforation of the bowel by a fish bone: formation of intra-abdominal abscess: opened. Recovery . . . . .	334
LXVIII.	Passage of a portion of a rabbit's femur into the bladder: expulsion <i>per urethram</i> . Recovery . . . . .	335
LXIX.	Temporary intestinal obstruction from ingestion of a quantity of gooseberry skins . . . . .	337

NO. OF CASE		PAGE
LXX.	Wandering and encysted needles . . . . .	338
LXXI.	Perforation of a typhoid ulcer: laparotomy: suture of the perforation. Recovery . . . . .	347
LXXII.	Perforation of a typhoid ulcer: laparotomy: suture of the perforation. Recovery . . . . .	348
LXXIII.	Hernia of a portion of the ileum into the fossa duo- deno-jejunalis: strangulation: laparotomy. Death	351
LXXIV.	Strangulation of the ileum through an aperture in the mesentery: operation. Death . . . . .	352
LXXV.	Intestinal obstruction due to the occlusion of the ileum by a band: operation. Recovery . . . . .	366
LXXVI.	Acute intestinal obstruction produced by Meckel's diverticulum. Death . . . . .	367
LXXVII.	Acute intestinal obstruction from constricting adhe- sions the result of repeated attacks of appendi- citis: laparotomy: separation of adhesions. Recovery . . . . .	371
LXXVIII.	Ileo-cæcal intussusception: laparotomy: reduction. Recovery . . . . .	382
LXXIX.	Intussusception. Successful reduction by inflation .	383
LXXX.	Intussusception treated by injection: rupture. Death	384
LXXXI.	Subacute intussusception: seven weeks' duration: laparotomy: reduction. Recovery . . . . .	388
LXXXII.	Volvulus of ileum the result of traumatism: laparo- tomy: untwisting. Recovery . . . . .	392
LXXXIII.	Tubercular stricture of the intestine: excision. Recovery . . . . .	394
LXXXIV.	Stricture of ileum, secondary to ulceration produced by strangulation of the bowel in a femoral hernia: perforation. Death . . . . .	395
LXXXV.	Simple stricture of the small intestine at junction of jejunum and ileum: enteroplasty. Recovery . . . . .	396
LXXXVI.	Gall-stone causing acute intestinal obstruction: entero-lithotomy. Recovery . . . . .	408
LXXXVII.	Intestinal concretion causing prolonged symptoms of obstinate constipation . . . . .	409
LXXXVIII.	Spontaneous disappearance of a solid tumour of the intestines causing obstruction. Enterostomy . .	412

*LARGE INTESTINE*

LXXXIX.	Simple ulcer of sigmoid flexure . . . . .	433
XC.	Simple stricture of sigmoid flexure. . . . .	441
XCI.	Strangulated diaphragmatic hernia: symptoms of acute intestinal obstruction: laparotomy. Death	445
XCII.	Volvulus of sigmoid flexure, successfully reduced after laparotomy . . . . .	451

NO. OF CASE	PAGE
XCI. Two enteroliths in the colon, successfully removed by colotomy . . . . .	454
XCIV. Chronic constipation, causing dilatation and rupture of the sigmoid flexure . . . . .	457
XCV. Acute intestinal obstruction caused by fæcal accumulation: colostomy. Recovery . . . . .	460
XCVI. Carcinoma of the ascending colon causing chronic obstruction: colectomy. Recovery . . . . .	472
XCVII. Carcinoma at the junction of the cæcum and ascending colon causing acute obstruction: colostomy: intestinal anastomosis. Death three months after from exhaustion . . . . .	473
XCVIII. Congenital dilatation of the colon. Death . . . . .	480
XCIX. Embolism of the inferior mesenteric artery, with symptoms of obstruction: laparotomy. Death . . . . .	488
C. Acute appendicitis: abscess formation: incision. Recovery . . . . .	504
CI. Relapsing appendicitis: appendicectomy. Recovery . . . . .	505

*RECTUM*

CII. Injury to rectum: abscess formation. Recovery . . . . .	570
CIII. Impaction of seeds, fruit stones, and husks in the rectum: acute proctitis: removal. Recovery . . . . .	576
CIV. Acute proctitis the result of taking large doses of patent cathartic remedies . . . . .	579
CV. Dysenteric ulceration of the rectum . . . . .	583
CVI. Tubercular ulceration of the rectum . . . . .	584
CVII. Simple ulcer of the rectum due to varicose veins . . . . .	585
CVIII. Non-malignant stricture of the rectum: linear proctotomy. Recovery . . . . .	597
CIX. Papilloma or villous tumour of the rectum . . . . .	601
CX. Illustrating the bad effects of perineal excision of the rectum . . . . .	624
CXI. Posterior proctectomy (Kraske). Recovery with sacral anus . . . . .	634
CXII. Carcinoma of rectum: sigmoid anus. Recovery . . . . .	635
CXIII. Intussusception of the rectum . . . . .	653
CXIV. Rectal hernia . . . . .	654
CXV. Anal cul-de-sac, but rectum imperforate: sigmoid anus: subsequent opening into rectum from perineum. Death in seven months from scarlet fever . . . . .	669
CXVI. Double stricture of the rectum from pelvic cellulitis: acute obstruction. Death . . . . .	675

*LIST OF TABLES OF SUCCESSFUL OPERATIONS FOR  
PERFORATION OF GASTRIC ULCER AND ACUTE  
INTESTINAL OBSTRUCTION*

Table of cases of perforation of gastric ulcer successfully treated by operation since 1891 . . . . .	188
Table of successful operations for internal strangulation from 1891 to 1895 inclusive . . . . .	362
Table of successful cases of laparotomy for intussusception from 1891 to 1895 inclusive . . . . .	385
Table of successful cases of laparotomy for volvulus of small intestine from 1891 to 1895 inclusive . . . . .	392
Table of successful cases of entero-lithotomy for impacted gallstones causing intestinal obstruction, from 1891 to 1895 inclusive . . . . .	408

# LIST OF ILLUSTRATIONS

[R.I.M.Glas = Royal Infirmary Museum, Glasgow. W.I.M. = Western Infirmary Museum. V.I.M. = Victoria Infirmary Museum.]

## LIST OF PLATES

PLATE	FIG.		PAGE
I.	1.	HALF-CROWN IMPACTED IN THE ŒSOPHAGUS . . .	19
II.	2.	A HALFPENNY IMPACTED IN THE ŒSOPHAGUS . . .	24
III.	7.	CARCINOMA OF THE ŒSOPHAGUS CAUSING PERFORATION AND GANGRENE OF LUNG . . . . .	60
IV.	8.	CARCINOMA OF THE ŒSOPHAGUS NEAR CARDIAC ORIFICE	68
V.	9.	CARCINOMA OF THE ŒSOPHAGUS PRODUCING DILATATION ABOVE . . . . .	74
VI.	13.	DIVERTICULUM OF THE ŒSOPHAGUS . . . . .	118
VII.	14.	PERFORATING ULCER OF STOMACH SITUATED IN LESSER CURVATURE . . . . .	176
VIII.	15.	CHRONIC ULCERS OF STOMACH, HEALED AND PERFORATING . . . . .	180
IX.	{	16. CARCINOMA OF STOMACH . . . . .	204
		17. CARCINOMA OF STOMACH . . . . .	
X.	18.	CARCINOMA OF PYLORUS . . . . .	212
XI.	41.	PERFORATING ULCER OF DUODENUM . . . . .	278
XII.	42.	PERFORATING ULCER OF DUODENUM . . . . .	280
XIII.	43.	PERFORATING ULCER OF DUODENUM . . . . .	282
XIV.	44.	RUPTURE OF JEJUNUM . . . . .	306
XV.	47.	TYPHOID ULCERATION AND PERFORATION . . . . .	342
XVI.	49.	MECKEL'S DIVERTICULUM . . . . .	358
XVII.	52.	ILEO-CŒCAL INTUSSUSCEPTION . . . . .	376
XVIII.	55.	STRICTURE OF SMALL INTESTINE . . . . .	394
XIX.	57.	DIAPHRAGMATIC HERNIA . . . . .	446
XX.	58.	CYLINDER-CELLED CARCINOMA OF TRANSVERSE COLON	466
XXI.	59.	CARCINOMA OF COLON CAUSING STRICTURE . . . . .	468
XXII.	60.	COLLOID CARCINOMA OF SIGMOID FLEXURE . . . . .	470
XXIII.	61.	ROUND-CELLED SARCOMA OF LARGE INTESTINE . . . . .	476
XXIV.	63.	PERFORATION OF VERMIFORM APPENDIX . . . . .	502
XXV.	64.	CYSTIC VERMIFORM APPENDIX . . . . .	517
XXVI.	99.	CHRONIC ULCERATION OF ENTIRE RECTUM . . . . .	582
XXVII.	104.	COLLOID CARCINOMA OF RECTUM . . . . .	615



## LIST OF FIGURES IN TEXT

FIG.		PAGE
3.	BRISTLE PROBANG . . . . .	31
4.	COIN CATCHER . . . . .	32
5.	ŒSOPHAGEAL FORCEPS WITH PERPENDICULAR CURVE . . . . .	33
6.	SIMPLE PERFORATING ULCER OF THE ŒSOPHAGUS . . . . .	47
10.	SYMONDS'S SHORT TUBE FOR CANCER OF THE ŒSOPHAGUS . . . . .	76
11.	SYMONDS'S SHORT TUBE WITH INTRODUCERS READY FOR USE . . . . .	76
12.	SYMONDS'S SHORT TUBE ( <i>in situ</i> ) . . . . .	76
19.	DIAGRAM SHOWING LINES OF INCISION ADOPTED RESPECTIVELY BY VON HACKER, FENGER, AND HAHN, FOR GASTROSTOMY . . . . .	233
20.)	GREIG SMITH'S MODE OF FIXING THE STOMACH IN GASTRO- STOMY . . . . .	235
21.)		
22.)	JESSETT'S MODE OF FIXING THE STOMACH IN GASTROSTOMY . . . . .	237
23.)		
24.)		
25.)	WITZEL'S METHOD OF PERFORMING GASTROSTOMY . . . . .	243
26.)		
27.)	FRANKS'S METHOD OF PERFORMING GASTROSTOMY . . . . .	245
28.)		
29.	BARKER'S METHOD OF CLAMPING INTESTINE WITH RUBBER TUBE	250
30.)	MAYLARD'S METHOD OF CLAMPING INTESTINE WITH RUBBER- PROTECTED DISSECTING FORCEPS . . . . .	250, 251
31.)		
32.)		
33.)		
34.	SENN'S DECALCIFIED BONE PLATE READY FOR USE . . . . .	254
35.)	MURPHY'S METAL BUTTON . . . . .	256
36.)		
37.)		
38.)	HEINEKE-MIKULICZ OPERATION OF PYLOROPLASTY . . . . .	266
39.)		
40.)		
45.	PISTOL-SHOT WOUND OF SMALL INTESTINE . . . . .	321
46.	TUBERCULAR ULCER OF INTESTINE . . . . .	340
48.	STRANGULATION OF A LOOP OF SMALL INTESTINE BY A FIBROUS BAND . . . . .	355
50.	STRANGULATION OF A LOOP OF SMALL INTESTINE BENEATH MECKEL'S DIVERTICULUM . . . . .	357
51.	DIAGRAM OF A LONGITUDINAL SECTION OF AN INTUSSUSCEPTION	373
53.	ILEO-CÆCAL INTUSSUSCEPTION . . . . .	374
54.	INTUSSUSCEPTION. A SLOUGH OF ILEUM PASSED PER RECTUM	378
56.	ILEO-CÆCAL VALVE . . . . .	429
62.	ENORMOUS CONGENITAL DEVELOPMENT OF THE COLON . . . . .	478
65.	MAYDL'S OPERATION FOR JEJUNOSTOMY . . . . .	524
66.	ALBERT'S OPERATION FOR JEJUNOSTOMY . . . . .	525
67.)	METHODS OF PERFORMING ENTERO-ANASTOMOSIS AFTER ENTERECTOMY . . . . .	527
68.)		
69.)		

FIG.		PAGE
70.	METHODS OF UNITING BOWEL ENDS BY SIMPLE CIRCULAR SUTURE . . . . .	529
71.		
72.		
73.	BISHOP'S SUTURE . . . . .	530
74.	ABBE'S SUTURE . . . . .	531
75.		
76.	MAUNSELL'S SUTURE . . . . .	533
77.		
78.		
79.		
80.	HALSTED'S SUTURE . . . . .	534
81.		
82.		
83.		
84.	SENN'S DECALCIFIED BONE PLATES; SHOWING MODE OF THREADING PLATES . . . . .	536, 537
85.		
86.		
87.	SENN'S METHOD OF LATERAL ANASTOMOSIS . . . . .	538
88.	PAUL'S METHOD OF SUTURE WITH DECALCIFIED BONE TUBES .	539
89.		
90.		
91.	ROBINSON'S METHOD OF SUTURE WITH INDIARUBBER TUBE .	540
92.	ROBSON'S DECALCIFIED BONE BOBBIN . . . . .	540
93.	MURPHY'S METHOD OF UNION WITH METAL BUTTON . . . .	541
94.		
95.		
96.	PAUL'S METHOD OF PERFORMING COLECTOMY . . . . .	548
97.	SHORT CIRCUITING WITH OCCLUSION OF A PORTION OF INTES- TINE . . . . .	549
98.		
99.		
100.	RECTAL BOUGIES . . . . .	595
101.		
102.		
103.	CREDÉ'S RECTAL BOUGIE . . . . .	598
104.		
105.	ROBERTS'S OPERATION FOR PROLAPSE OF THE RECTUM . . .	645
106.	MIKULICZ'S OPERATION FOR PROLAPSE OF THE RECTUM . . .	646
107.	DIAGRAMMATIC REPRESENTATIONS OF MALFORMATIONS OF THE ANUS AND RECTUM . . . . .	656
108.		
109.		
110.		
111.		
112.		
113.		
114.		
115.		
116.		
117.	OS SACRUM, SHOWING THE AMOUNT OF BONE REMOVED IN OPERATING UPON THE RECTUM . . . . .	684

THE SURGERY  
OF THE  
ALIMENTARY CANAL

---

PART I  
*THE ŒSOPHAGUS*

---

CHAPTER I

SURGICAL ANATOMY AND PHYSIOLOGY

**Surgical Anatomy.**—The relations of the œsophagus to surrounding parts are of considerable importance. Not only are important parts in immediate proximity to the canal liable to be affected by conditions of the œsophagus itself, but diseases arising from the surrounding parts are in their turn liable to produce complications of which the œsophageal troubles are only symptoms. But, apart from the consideration of disease, these same surrounding structures render operations upon the canal of special difficulty, or at least in need of more than usual care.

**Course and Extent.**—The œsophagus extends from the cricoid cartilage above to about opposite the body of the tenth dorsal vertebra below; this lower point corresponding posteriorly with the apex of the ninth dorsal spine, and anteriorly with the junction of the seventh costal cartilage with the sternum on the left side. It is from nine to ten inches in length, and takes a somewhat sinuous course. At first situated in the median line, it deviates as it descends to the left side, so that at the root of the neck it has become deflected about half

an inch. From this point it again passes to the middle line, reaching its original axis opposite the body of the fifth dorsal vertebra. It again deviates slightly to the left as it passes through its opening in the diaphragm. This latter point is approximately opposite the spine of the ninth dorsal vertebra. Besides a lateral deviation, the œsophagus is curved in an antero-posterior direction. Following the course of the spinal column, it is first directed slightly forward by the convexity of the cervical curve; this, however, almost at once gives way to a concave curve as it sinks into the root of the neck and on into the thoracic dorsal curvature. This latter curve, according to Morell Mackenzie, disappears in the erect posture. As the tube enters the thorax at the root of the neck, its distance from the surface in the adult is from one and a half to two inches, the variation depending upon the shortness and fatness of the part. Before leaving the thorax it is directed somewhat forwards to enter its aperture in the diaphragm. Not more than half an inch intervenes between the diaphragm and its junction with the stomach.

**Attachments.**—The œsophagus, except towards its termination, is only loosely attached by connective tissue to the surrounding parts. The curves therefore easily straighten in the passage of stout bougies, and the tube is permitted to accommodate itself, in some degree, to pressure from without. The most fixed point is at the diaphragm.

**Relations.**—*Behind.*—The œsophagus is in close contact with the spinal column for most of its length. As it leaves the thorax the aorta intervenes.

*In front.*—It has first of all the trachea; lower in the neck, where it deviates to the left side, the thyroid gland and the thoracic duct. After entering the thorax it is crossed by the arch of the aorta and the left bronchus; for the rest of its extent it is covered by the pericardium. On each side in the neck it has the carotid artery, the left being in closer contact than the right. In the thorax the aorta, after crossing the œsophagus at its upper part, lies to the left, and the vena azygos major to the right. It is also covered laterally by the pleuræ. In the neck the recurrent laryngeal nerves ascend between it and the trachea; while in the thorax the pneumogastric nerves descend in close contact with it.

**Calibre.**—The œsophageal canal is the narrowest of any portion of the alimentary tract; and narrower in itself at the commencement opposite the cricoid cartilage and at the exit through the diaphragm. It is also constricted somewhat at the point where it is crossed by the left bronchus. Mouton, by obtaining a cast of the canal with plaster of Paris, found that at these three constricted parts the internal diameter measured a little above half an inch, while at other parts it was about three-quarters of an inch. By forcible dilatation it was found possible to increase the diameter of the cricoid and bronchial constrictions to about three-quarters of an inch, the diaphragmatic to nearly an inch, and the other parts to about an inch and a half. It must, however, be remembered that these are post-mortem experiments and cannot well be accepted as examples of what amount of dilatation can take place during life. They are of value, however, in giving information regarding the relative diameter of different parts of the canal. Mackenzie, experimenting in the same way, showed that the antero-posterior diameter is considerably less than the transverse.

**Structure.**—The œsophagus resembles other portions of the alimentary tract in being composed of muscular, fibrous, and mucous coats. In comparison with other regions its muscular coat is very thick; the fibrous coat is also thick, although loose in texture, and the mucous coat, lined with several layers of squamous epithelium, is similarly thick and firm. This last coat is thrown into numerous longitudinal folds when the canal is at rest, that is, when not distended. Numerous mucous glands exist in the submucous or fibrous layer. The arteries are disposed mostly longitudinally, and are more abundant at the upper than the lower part, hence the paler appearance of the canal below. The veins form plexuses in the submucous tissue and in the peri-œsophageal tissue. Numerous anastomoses are formed between these plexuses and the veins of the portal system and the vena cava (C. A. Blume).<sup>1</sup> The lymphatics of the thoracic part pass into the posterior mediastinal glands, while those of the cervical portion go to the deep glands beside the carotid sheath. The nerve supply is through the pneumogastric.

<sup>1</sup> *Annual of the Universal Medical Sciences*, 1889, vol. iv. G—36.

**Physiology.**—The functions of the œsophagus are essentially those connected with the rapid transmission of the food from the pharynx to the stomach. The muscular coat is specially thick for this purpose, and the numerous glands admit of an abundant viscid secretion for lubrication. The constant friction to which the internal surface is exposed is met by the extra thick layer of squamous epithelium. With regard to the rate of progress in the canal, Ogston found that the time required for the passage of food from the mouth to the stomach was about four seconds. To determine this, the finger of one hand is placed on the *pomum Adami*, the other hand holds the watch, and the ear is placed ‘behind the left thorax, three inches below the angle of the scapula.’ When some fluid is swallowed, the time is reckoned from the moment the *pomum* is felt to rise, till a ‘distinct amphoric gurgle or amphoric rushing sound’ is heard, indicating the passage of the fluid into the stomach.<sup>1</sup>

---

## CHAPTER II

### INJURIES. INTERNAL AND EXTERNAL INJURY. RUPTURE

INJURIES to the œsophagus may arise from causes either inside or outside the canal. Those inflicted from within are the more frequent, and as a rule the less severe. On the other hand, in the case of external injuries, the depth of the gullet from the surface, and the important structures surrounding it, prevent generally any material damage to the former, without far more serious concomitant injury to the latter. Injuries inflicted therefore from without may be looked upon more as surgical curiosities, for either life has already become extinct before the surgeon sees the case, or the injury is so hopelessly irreparable as to be beyond treatment. Cases, however, are occasionally met with where surgical measures have succeeded. These will be referred to later on.

**Internal injuries.**—These may be of the nature of incised, punctured, or lacerated wounds, and burns or scalds. Any part of the wall of the canal may be injured. The narrower

<sup>1</sup> *Medical Chronicle*, 1886, vol. v. p. 280.

parts opposite the cricoid cartilage and the diaphragm are those which most frequently suffer. The injury may be of any degree, from a single scratch or abrasion to a perforation. In the latter case neighbouring important structures may also be injured.

The agencies whereby these various wounds are produced are extremely numerous. Exclusive of such materials as cause burns or scalds, objects of all sizes and descriptions have been swallowed, intentionally or accidentally; swords, foils, and other sharp-edged weapons have been inserted for juggling or suicidal purposes. The nature of the wound produced will largely depend upon the shape and consistency of the body introduced. In the case of sharp-edged or sharp-pointed weapons the wound will be an incised or punctured one. In that of metallic substances, or irregular-shaped splinters of bone, broken bits of china, and other suchlike hard brittle jagged bodies, the injury will be mostly of a lacerated character.

**Symptoms.**—These will depend largely upon the nature of the lesion. A mere abrasion or scratch will give rise to a feeling of soreness in the process of deglutition, and frequently create the impression that a foreign body has become impacted at the spot where pain is complained of. A deeper injury will cause some bleeding, and this may give rise to cough with bloody expectoration or vomiting of blood that has passed into the stomach. A punctured or perforating wound will give rise to symptoms depending mostly upon the organ or structure simultaneously injured. Thus involvement of a large blood vessel will produce rapid symptoms of hæmorrhage; an opening into the trachea or left bronchus, to cough and expectoration of blood, mucus, and food; perforation of the pleura or pericardium, to considerable collapse. To these immediate symptoms may be added great thirst, pain, and dysphagia. Later, symptoms will be mostly of an inflammatory character, due to the communication opened up between the œsophagus and the neighbouring parts. Thus an abscess may form from simple penetration of the cellular tissue in the neck or mediastinum; pleurisy, empyema, and pneumothorax from opening of the pleural cavity; and similarly pericarditis from perforation of the pericardial cavity. Pneumonia may arise either as

secondary to inflammation of the pleura or as a result of injury to the air passages themselves.

**Diagnosis.**—Internal injuries to the œsophagus will be, in the first place, mostly recognised by the previous history of the case ; and the nature of the lesion will also often be arrived at by the kind of body producing it. In the second place, the symptoms associated with the act of deglutition, such as dysphagia, localise pain, and regurgitation or vomiting of blood will leave little doubt regarding the region injured.

**Prognosis.**—Judging from the way in which wounds produced by the surgeon heal, the œsophagus is in no way exceptional in its recuperative powers. Hence when the injury has not been of a grave nature and the exciting cause has been removed, a good result may be expected. Should, however, the lesion have been produced by a foreign body which has not been passed on into the stomach, nor extracted, other results must be expected. These will be treated of later. In cases of severer injuries, where the immediate symptoms point to the involvement of other structures and parts, the prognosis will have to be a guarded one. If the case be not rapidly fatal, there are all the possible secondary complications arising from septic causes. The final issue of the case then turns upon these sequelæ and their treatment.

CASE I.—*A diffuse pericœsophageal abscess in a 'sword swallower.'*

R. S., æt. 30, was admitted into St. Saviour's Infirmary, Walworth, January 17, 1885. Two days before admission he had been performing at a public-house, swallowing a sword. The feat on this occasion hurt him more than usual, and he spat a little blood immediately afterwards. He then felt great pain about the throat and œsophagus, much increased on swallowing. On admission the neck was swollen and tender, breathing shallow and hurried, and he continually spat up a little glairy mucus not stained with blood. He gradually became worse, and died suddenly on January 20. The autopsy showed a diffuse abscess extending along the pharynx and œsophagus. The mucous membrane of the latter was thickened, quite smooth, and white in colour. The outermost coat and surrounding tissue were infiltrated with pus. The left vagus was seen running through the abscess cavity at the lower part. There was no evidence of any perforation or wound, and only a slight excoriation at the upper and posterior part. The condition of the mucous membrane showed a chronic thickening from the continual irritation of the part by the passage of the hard solid substances. The man had been a sword swallower and conjurer for years. (Gross, 'Trans. Path. Soc. Lond.' 1885, vol. xxxvi. p. 188.)



In the case of burns, the gravity of the immediate symptoms is not connected with injury to the œsophagus, but rather with affection of parts about the larynx and pharynx. Apart from a knowledge of the nature of the fluid or material swallowed, it may be fairly stated that as regards the œsophagus the prognosis is directly proportionate to the severity of the symptoms connected with the injury to the larynx and pharynx. If there is much mischief here, then it is only too likely that the œsophagus will have suffered badly; and if this be the case, sloughing or ulceration may result, with the subsequent formation of stricture.

**Treatment.**—The essential basis of all treatment is rest. The surface of the mucous membrane must be protected from friction, and the muscles must be prevented from action. This is best effected by giving no food by the mouth, but feeding the patient with nutrient enemata.<sup>1</sup> Thirst may be appeased by a little ice given by the mouth; and should much pain exist it must be allayed by anodynes given subcutaneously or per rectum. A week or two should be allowed to elapse before food is given by the mouth, and then fluids only should be first administered. Special symptoms arising later will call for treatment according to the complications they indicate.

In the case of injuries produced by swallowing concentrated acids or caustic alkaline solutions, resort should be had as soon as possible to the imbibition of fluids or other substances which might either neutralise the agent swallowed or dilute its concentration. Thus without going into, to any extent, the treatment of those cases of poisoning which will be found more fully dealt with in books on general or forensic medicine, it may be briefly stated that the immediate administration of large quantities of water and its rapid removal by the stomach pump will often prove the best means at hand to adopt.

**External injuries.**—Apart from operations on the œsophagus and its accidental injury in tracheotomy, injuries inflicted from without, and involving the gullet alone, are comparatively rare. Such, however, have occurred from bullets, sword, foil or dagger thrusts inflicted in war, or with homicidal intent. Far more common is it for such injuries to be associated with serious mischief to other and neighbouring parts.

<sup>1</sup> See Chapter LXXXIV.

The nature of the wound may be incised, punctured, or lacerated, and may pass simply into the canal or entirely through it. In cases of strangulation or garroting the œsophagus may be contused.

**Symptoms.**—Many of these will be those already given in the case of internal injuries: there will be pain, dysphagia, and cough; possibly great thirst and troublesome hiccough, and symptoms arising from general disturbance. In addition there are those connected with the external wound, such as the escape of mucus or ingesta. To what extent these latter symptoms may manifest themselves will largely depend on the size and nature of the opening.

**Diagnosis.**—Where the symptoms are marked, little difficulty will be experienced in deciding whether or not the gullet has been injured. Care must, however, be taken not to conclude that the escape of food from the wound is necessarily an indication of perforation of the gullet. A simple opening into the trachea may prove a source of exit for fluids which have trickled into the larynx from some defective action of the glottis. The direction of the wound, and its depth, will also assist in localising the injury. With regard to the nature of the wound, this may be approximately gathered from the character of the agent causing it.

**Prognosis.**—With the exception of uncomplicated incised wounds, all other injuries must be looked upon as of considerable gravity. A lacerated wound, such as that produced by a bullet, may lead on the one hand to a stricture, or on the other to a fistulous communication with the skin surface. Various septic conditions may arise of more or less serious character. In cases of severe hæmorrhage where death has not occurred immediately, the great loss of blood may seriously affect the recuperative powers of the patient. That even comparatively severe gunshot injuries may sometimes recover, Solis-Cohen has pointed out, quoting from the medical and surgical history of the war of the Rebellion, twelve cases, where recovery occurred in as many as six. In cases of almost complete severance of the canal and serious interference with its continuity, death may subsequently ensue from starvation, it being found impossible to supply sufficient nourishment. In cases of injury to the œsophagus in the thorax, the pro-

gnosis is necessarily bad. If not almost immediately fatal, there are all the secondary complications of the same nature as those already given in the case of internal injuries.

**Treatment.**—In treating wounds of the œsophagus inflicted from without, we have to devote as much attention to the patient generally as to the wound in particular. In other words, we have to keep up the patient's strength without interfering deleteriously with the wound. As regards the wound, the first question which usually presents itself is whether an endeavour should or should not be made to close the opening in the œsophagus. This can only be answered by a careful consideration of the nature of the wound itself. In cases of clean-cut, incised, or punctured wounds an endeavour may safely be made to completely occlude the aperture. This may be done either by a continuous or interrupted suture of sterilised silk or gut. And, further, where the wound is recent and it is believed that it is or can be rendered aseptic, the external wound may also be closed. In every case of doubt, however, on this latter point, and where also the closure of the œsophageal wound leaves doubt as to its efficiency, the external or surface wound should, if not left wholly open, be very thoroughly drained by tubes. Lacerated wounds of the gullet admit, as a rule, of but little treatment, and may even sometimes have to serve as apertures for the admission of a feeding tube. Cases of this kind are apt to leave troublesome external fistulæ, and treatment subsequently resolves itself into measures for the occlusion of these. For this purpose the usual means for such conditions may be adopted, as the cautery, caustic, &c.

In any kind of wound of the œsophagus, and especially if it be associated with wound of the trachea, the head should be secured by bandages to the trunk, so that as little movement as possible of the neck is permitted. Any complications which subsequently arise must be treated on general surgical principles.

As regards the patient, our chief consideration concerns the efficient administration of nourishment. Rectal alimentation should in all cases be adopted, and if this can be successfully carried on for over a week, the best opportunity is afforded for the wound to heal. Cases, however, will occur where such means of nutrition will prove inefficient and something must be conveyed to the stomach. The best method,

if possible, is the natural one, the administration of nutrient fluids in teaspoonful doses by the mouth. If this cannot be done, then a stomach tube must be passed by the mouth if possible, or, if that be not possible, by the wound. The chief objection to the use of the tube is not only the injury it may inflict upon the wound in its passage, but the likelihood of its inducing retching or vomiting, results which would themselves act injuriously in unduly stretching the parts. It need hardly be said that in cases which have done well under rectal alimentation the return to feeding by the mouth should be both gradual and cautious. Bland unirritating nutrient fluids should be given first in small quantities—a teaspoonful at a time. Only after the lapse of a fortnight or three weeks should solid food be attempted, and even then only foods of a soft consistency and that have been well masticated. The sole endeavour being not to overdistend the wounded region, precautions should be taken accordingly. In cases of great thirst, the fluid should be administered by enemata, and, if necessary, ice may be given to suck. Pain may be allayed by the usual anodyne measures.

**Rupture of the œsophagus.**—Judging from the comparatively few recorded cases, rupture of the œsophagus must be a very rare accident, and still rarer are those cases in which the rupture has occurred in a practically healthy organ. Many of the earlier cases recorded, as shown by Fitz,<sup>1</sup> are too doubtful to be accepted as illustrations of the accident, and many also recorded as ruptures are the result of post-mortem softening of the walls.

The nature of this rare accident will be best illustrated by the brief record of a few cases.

*CASE II.—Rupture produced by vomiting.*

A man, aged 47 years, had for some months suffered from troublesome dyspeptic symptoms, giving rise to frequent attacks of vomiting, and suggesting the possibility of malignant obstruction at the pylorus. After swallowing some milk arrowroot, he vomited, and was seized with sudden and intense pain in the lower part of the left side of the chest. He thought that something had burst in his stomach. Marked collapse rapidly ensued, with rapid and weak pulse, hurried respiration, and some difficulty in breathing; temperature subnormal. A few hours later, subcutaneous

---

<sup>1</sup> Fitz, *Am. J. Med. Sciences*, 1877, N.S. vol. lxxiii. p. 17.

emphysema of the neck, cheeks, and upper part of the chest developed. On examining the chest the area of cardiac dulness was observed to have disappeared, and this region and the upper part of the left lung were found to be hyper-resonant on percussion. Respiratory sounds were feeble, though present over the left lung in front, and exaggerated over the right lung. The emphysema gradually increased, the pulse became weaker, and death ensued thirteen and a half hours after the onset of the acute symptoms.

*Post mortem.*—Extensive emphysema existed everywhere, reaching as low as the groins. Each pleural cavity contained about a pint of dark grumous fluid having the odour and appearance of the contents of the stomach. On examining the œsophagus a longitudinal rent an inch and a half long was found in its walls just above the diaphragm. The edges of the rent were sharply defined and gave no evidence of induration or of a fore-existing ulcerative or degenerative process. They bore no indication of post-mortem softening. No constriction or dilatation of the œsophagus existed, and no pouch or thinning of its walls could be detected. The stomach was somewhat dilated. At the pyloric orifice a small nodule of carcinoma was found, and the whole circumference of the orifice was more or less thickened and indurated by the disease. (C. E. Harrison, 'Lancet,' 1893, vol. i. p. 784.)

CASE III.—*Rupture of œsophagus during a violent endeavour to dislodge an impacted mass of food: death from exhaustion in seven and a half days.*

Mr. H., 31 years of age, suffered from debility due to long continued abuse of alcoholic stimulants. He suffered at times from attacks of gastritis, when he would frequently vomit blood. He never complained of pain or difficulty in swallowing. While at supper on January 26, 1876, he suddenly became partially choked by some article of food lodging somewhere in the throat. After an hour of great discomfort and intense anxiety, he succeeded, by a concentration of his entire muscular energy, in ejecting the obstructing fragment. He sank back upon the sofa exhausted, and almost immediately ejected a moderate quantity of clotted and liquid blood. After being put to bed he complained of thirst; fluids were swallowed easily and without discomfort. He vomited once, an hour after the food was ejected, and the vomit contained no blood. Emphysema of the neck was marked and continued to increase. On the following day the emphysema had further extended; thirst was constant, and vomiting frequent, blood being occasionally present in the ejecta. Swallowing was without difficulty and without pain. Weakness and prostration increased, and on February 3—seven and a half days after the onset of his troubles—he died. At the autopsy a rent in the œsophagus was found, two inches in length, and extending through all its coats, situated in front and to the right, at and below the bifurcation of the trachea. No evidence of disease of any kind was found in the region of the rupture. (Fitz, 'American Journal of the Medical Sciences,' 1877, N.S. vol. lxxiii. p. 18.)

These two cases illustrate rupture of an apparently healthy œsophagus. The following lesion occurred in a patient where there was reason to believe from the post-mortem appearances that the œsophagus had been weakened by previous ulceration.

CASE IV.—*Rupture of the œsophagus during vomiting after a heavy meal: death in seven hours.*

The patient was a gentleman aged 53 years. He had been dyspeptic for several years, and occasionally vomited after food. On the day of his death he appeared unusually well and went out on a pleasure excursion. He returned to his dinner in the afternoon and ate heavily of a rump steak. About two hours after his dinner he complained of faintness and left the room. Soon afterwards he was heard retching in the watercloset, and then to utter a shriek. He returned to the dining-room pale as death, threw himself on to the sofa, complaining of great pain in his left side and shoulder. When seen by his doctor he was in a cold sweat, breathing quick and short, his pulse 122, and his face expressive of agony. He kept his left hand firmly pressed upon his left side, where he complained of severe pains extending to the point of the left shoulder. He died seven hours after the sickness. At the post mortem a slit was found in the œsophagus a quarter of an inch in length, immediately above the diaphragm. The left pleural cavity contained about a pint of undigested food, amongst which was a piece of gristle of beef, an inch and a half long and an inch broad, which was supposed to be the agent which had caused the rupture. (William Adams, 'Trans. Path. Soc. Lond.' 1878, vol. xxix. p. 113.)

The following two cases illustrate a form of rupture rather of pathological than surgical interest. In these cases it will be seen that the rupture has indirectly occurred as the result of gastric solution of the walls of the œsophagus, the latter process occurring from enfeeblement of the parts just prior to death.

CASE V.—*Rupture of the œsophagus: softening of the walls by gastric solution just prior to death.*

A child aged 4 months was admitted into University College Hospital, under the care of Mr. Godlee, with the symptoms of strangulated hernia. He was relieved, but some days later took erysipelas, and finally septic peritonitis, of which he died. Before death the child was in a very exhausted condition. He vomited frequently on the last night but one before death, but on the last night not at all. Rather more than two hours before death sudden difficulty in breathing appeared, and continued for an hour. Inspiration was accompanied by a whiffing noise. After the dyspnœa had passed off, he took food in very small quantities and without difficulty until twenty-five minutes before death. At the post mortem, at a point midway between the bifurcation of the trachea and the

opening in the diaphragm, a small hole was found in the œsophagus on the right side. Both inside and outside the gullet a little blood-stained fluid and clots were found, but no milk in the latter situation. The margin of the opening, which was circular, was smooth above and quite thin below, and in general suggested gastric solution of the part. (Stanley Boyd, 'Trans. Path. Soc. Lond.' 1882, vol. xxxiii. p. 123.)

CASE VI.—*Rupture of the œsophagus where the walls had become softened by gastric solution.*

E. B., a young woman aged 18, was admitted into University College Hospital under the care of Mr. Heath. She was in a state of great collapse, and died in ten or twelve hours. She was vomiting on admission, and every kind of stimulant or food given by the mouth returned unaltered before it could have reached the stomach. She complained of pain about the lower end of the sternum, but it was not severe. There was no dyspnoea and no subcutaneous emphysema noticed. The patient passed water in the bed. At the post-mortem examination two or three ounces of bloody fluid which contained no food were found in the left pleura and seemed to have come from a rent in the left side of the œsophagus. The aperture was longitudinal, about two inches in length, and situated immediately above the cardia. The slitlike character of the aperture, and the existence of an uneven furrow between the longitudinal rugæ and parallel with it, led to the belief that gastric solution had taken place at the seat of rupture. (Stanley Boyd, 'Trans. Path. Soc. Lond.' 1882, vol. xxxiii. p. 125.)

In this case it was subsequently ascertained that the patient was suffering from Addison's disease, and that the vomiting with which she was troubled on admission was part of the symptoms of that disease. It had, however, proved the immediate cause of death, by leading to rupture of the œsophagus.

The cases thus quoted will serve to illustrate the various forms in which rupture may occur. They may be divided into three classes :

1. Spontaneous rupture in a practically healthy canal.
2. Spontaneous rupture in a canal weakened either by ulceration or cicatrisation.
3. Spontaneous rupture in a canal which has undergone in parts gastric solution.

(1) In the first class, that of rupture of a healthy canal, the rupture can only occur as the result of some violent effort to expel an impacted body. The patient makes every possible effort to eject the body. The diaphragm is first fixed after an inspiration, and the lungs thus distended are made to endure

an overstrain in the endeavour to hawk up the substance. As a result of this strain, some rupture of the air vesicles may take place with consequent emphysema. Rupture also of small blood vessels may result, with expectoration of blood. Coupled with this is the intense anxiety of the patient, accompanied later with considerable exhaustion. Should the impacting body be expelled, as it may be by the final extraordinary effort which at the same time ruptures the œsophagus, it will be ejected with great force. The patient may at this moment become conscious of something having given way, and may or may not be attacked with sudden pain. The symptoms for some time will be those connected with the excessive exertion, and the great exhaustion thus entailed may mask any immediate indication of rupture. Later, however, symptoms will show themselves which, while giving no direct evidence of the lesion, will excite suspicion that there is more in the case than can be accounted for by the efforts at expulsion. The rupture will admit of the escape of material—not necessarily in any quantity—into the surrounding parts. The result will be the setting up of some septic action, and according to the seat of this action will be the symptoms which will subsequently arise. There may or may not be vomiting, and there may or may not be difficulty in swallowing.

It will thus be seen that the symptoms of rupture of the œsophagus in this class, as judged from the comparatively few cases recorded, are very variable and inconstant.

**Treatment.**—When it has been possible to make a diagnosis, or when suspicions lie in the direction of rupture, the treatment will be as already given under the head of Internal Injuries; and such complications as may subsequently arise will be treated on general surgical principles.

(2) In the second class of cases, where rupture has occurred in a previously weakened œsophagus, the cause is of a much less violent nature and the symptoms somewhat more characteristic. In this class probably come most of the cases usually recorded as rupture of the œsophagus. The patient may for some time previously have had symptoms indicating, if not definitely, some stomachic or œsophageal trouble, as, for instance, in a case reported by Morley,<sup>1</sup> where the man, who was

<sup>1</sup> Solis-Cohen, *Annual of the Universal Medical Sciences*, 1892, vol. iv. F—34.



a great drinker, had suffered from several attacks of chronic gastritis. On the other hand the patient may have appeared to enjoy good health.

The accident, it appears, occurs most frequently in men who have for long been addicted to alcohol, and arises usually during a fit of vomiting following in some cases—as in that of Adams's and Morley's—a heavy meal. The symptoms in this class of cases contrast somewhat with those of the preceding class. There being no preliminary violent exhaustive efforts at expulsion, the symptoms of rupture are not masked in any way and at once manifest themselves. The patient becomes suddenly faint. The face is anxious and pale, and suffused with perspiration; the pulse is feeble and quickened; the respiration is shallow and somewhat rapid. There may be fruitless attempts to vomit; possibly some dysphagia, and pain more or less localised. The symptoms may increase, and the patient die in a collapsed condition within a few hours. Should, however, the primary shock be rallied from, later symptoms may arise from the escape of material through the seat of rupture into the parts around. These complications will be of a septic character, and may cause death within a few days.

Little need be said of treatment. The same reference may be made, as in the preceding class, to what is indicated under Internal Injuries.

In both these classes of rupture, the lesion in the œsophagus has usually been found to be of a longitudinal slit-like character, situated in the thoracic portion and at some little distance from the diaphragm. There is, however, no special reason for the rupture occurring more at one point than another; the determining causes are probably the site of impaction and the existence of a previously weakened area. In the same way the length of the lesion will be determined by the force of expulsion and by the extent of weakness; thus in Adams's case it was only a quarter of an inch long, while in Fitz's it was two inches.

(3) The third class of cases, consisting of those in which rupture has occurred in an œsophagus weakened by gastric solution, is of comparatively little surgical interest. The accident occurs probably a few hours before death, and is the direct result of an attack of vomiting. The two cases of

Stanley Boyd already cited are illustrations of this form of rupture. The specimens of these two cases shown at the Pathological Society were submitted for examination to a committee, and the report presented by Goodhart and Butlin was as follows: 'We think the specimens may serve to call attention to the occurrence of gastric solution during the enfeeblement immediately preceding death; an occurrence which is probably not very common, which has never yet been adequately described, and which has produced within our knowledge the most puzzling appearances.'

---

### CHAPTER III

#### FOREIGN BODIES IMPACTED IN THE ŒSOPHAGUS

COMPARED with either disease or injury the impaction of foreign bodies in the œsophagus occupies by far the larger part of the surgery of this region. Little or nothing purely surgical may be needed in cases of disease or injury, but the existence of an impacted foreign body usually calls at some time, either early or late, for surgical interference. The accident is one which may happen to any person, but children and insane people form a class more prone to it than any other. In children it is usually the result of a body which, either in play or as a common habit in early life, has been put into the mouth, and then got too far back to be checked in its passage downwards by any voluntary effort at ejection. Once beyond the fauces the involuntary act of deglutition is brought into play, and if the body escape lodgment in the lower part of the pharynx, it passes on to become impacted in the œsophagus. In the case of insane people the act is a voluntary one. The patient, from some aberrant motive, attempts to swallow a body which frequently, from its irregular shape and hard consistency, readily becomes impacted. In the case of sane adults, the nature of the substances is usually that of some article of diet. False teeth, however, are occasionally dislodged and swallowed; and accidents sometimes happen when foreign bodies are inserted into the mouth for purposes of concealment.

**Nature of body impacted.**—While it is of the utmost import-

ance to the surgeon to know the nature, shape, size, and consistency of the body impacted, there is not much to be gained by an enumeration of the various substances that from time to time have been recorded as becoming impacted in the gullet. When it is remembered that insane people may swallow the most unlikely objects and that in children any plaything may prove the obstructing agent, little gain would be got by giving a list of these bodies. I would, however, refer the reader, who may wish information on this point, to an exhaustive table compiled by Poulet, and recorded in his work;<sup>1</sup> and also to Morell Mackenzie's work, where a similarly extensive enumeration is given.<sup>2</sup> Under the head of Treatment certain bodies will be singled out which call for special measures for their extraction or dislodgment.

**Seat of impaction.**—While any part of the œsophagus may become the seat of lodgment of a foreign body, there are certain regions where it more frequently happens. These are the upper and lower ends—opposite the cricoid cartilage and at the diaphragm—and where the left bronchus passes across. At these spots not only is the gullet narrower, but there is not the same proportional amount of distensibility admitted.

**Symptoms.**—The symptoms which arise in connection with the impaction of a foreign body vary within considerable limits. In the simplest case there may be no other indication of impaction beyond a certain ill-defined feeling of discomfort; while in the severest instance death may almost immediately result either from direct pressure on the trachea producing asphyxia, or reflex laryngeal spasm causing a similar result. As an illustration of sudden death, McIlraith<sup>3</sup> reports the case of a child aged 17 months in whose œsophagus a piece of gristle became impacted during a fit of coughing. Death resulted from asphyxia. The bolus was found pressing on both bronchi, completely occluding the left and partially the right. Between these limits of sudden death and only slight discomfort an extensive series of symptoms may manifest themselves, either local or general, immediate or remote, and most of them will be determined by the size,

<sup>1</sup> *On Foreign Bodies in Surgery*, vol. i. p. 71.

<sup>2</sup> *Diseases of the Throat and Nose*, vol. ii. p. 186.

<sup>3</sup> *Lancet*, 1892, vol. ii. p. 603.

shape, and consistency of the body impacted. A large body blocking the canal will give rise to violent symptoms connected mostly with persistent and exhausting endeavours on the part of the patient to eject it. Not only will there be aphagia but possibly also aphonia, with difficulty in respiration, inspiration being affected more than expiration. Pain may be felt either behind or in front, and corresponding more or less to the seat of impaction; in some instances the pain is referred to a region more or less remote from the seat of impaction, as in MacIntyre's case,<sup>1</sup> where the foreign body was impacted in the lower part of the neck, and the pain was felt at the 'pit of the stomach.' The patient will frequently endeavour to vomit, and these futile attempts will as frequently end in severe attacks of retching. There will be great anxiety, with possibly the production of various reflex spasms and neuralgic affections. Flexion of the neck was observed in one case (Cabot). In cases where there is some likelihood of laceration of the lining wall, from the irregularity and hardness of the impacted body, hæmorrhage to a greater or less extent may follow. Should the endeavour of the patient culminate successfully in the dislodgment of the body either upwards or downwards, the more violent symptoms will at once begin to subside, but the sense of some impaction may still linger. As already indicated,<sup>2</sup> rupture of the œsophagus may result during the violent endeavours at expulsion. In cases of a less severe nature, where total obstruction has not been produced, the symptoms will be much less marked. A sharp-pointed body, as a pin or fish bone, may give rise to a pricking sensation at the seat of impaction, accentuated by any endeavour on the part of the patient to dislodge it. Dysphagia may exist, as also retching and vomiting.

Such may be said to be the symptoms arising at the time of the accident, and they constitute the only symptoms should the body be successfully removed within a comparatively short time from its first impaction. If, however, the period be lengthened, either from inability to dislodge the body, or from the fact of the immediate symptoms passing off so that the patient is led erroneously to believe that it has been removed, other symptoms

<sup>1</sup> See page 24.

<sup>2</sup> See page 11.



PLATE I.

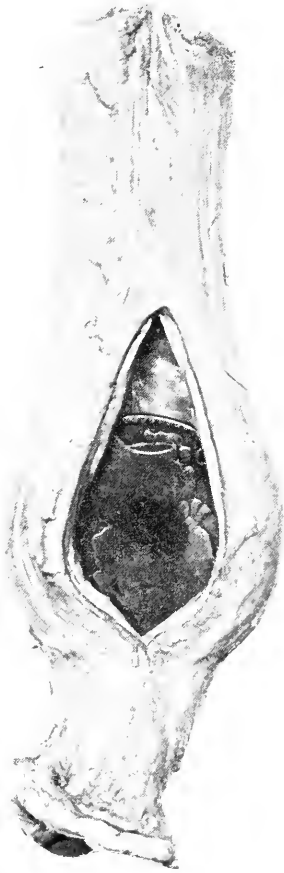

Fig. 1.—Half-crown piece impacted in the œsophagus, just behind the left auricle of the heart. (*Hunterian Museum, University of Glasgow.*)

will arise depending upon the nature of the lesion secondarily induced.

CASE VII.—*Coin impacted in the œsophagus : symptoms not urgent at first, but developing later.*

A child aged 2 whilst playing with a halfpenny accidentally swallowed it. The symptoms at the time not being urgent, matters were left alone. In the meantime he became gradually worse, losing flesh and experiencing some difficulty in swallowing. Twenty-eight days after the mishap he was brought into hospital suffering from dysphagia and a short dry cough, complaining always of a fixed pain at the lower portion of the sternum. When he was given some water to drink, it could not be swallowed without an effort. Solids he refused. The coin was removed by the probang, and all symptoms subsided. (Hugh Thomas, 'Brit. Med. Journ.' 1879, vol. ii. p. 891.)

In this case it is possible that some slight ulceration may have taken place at the seat of impaction, with inflammatory exudation around. Had the coin not been removed, it might have led to perforation. Such was the result in a case reported by Chaffey.<sup>1</sup> The child, aged 3 years, swallowed a coin—a halfpenny. No symptoms occurred at the time, and none till two months after, when the child brought up a little blood; this was followed a few hours after by a second attack of hæmorrhage, when the child succumbed. At the post mortem it was found that the coin lay in a cavity on the right side of the œsophagus. The cavity was about the size of a walnut, and situated just below the right sterno-clavicular articulation. A communication was found between the cavity and the innominate artery.

If we bear in mind the various structures and tissues in anatomical relation to the œsophagus, it is not difficult to conjecture what may be some of the complications likely to result from an ulcerative perforation of the canal. Indeed it may be said that cases have been recorded illustrative of almost every one of these possible complications. Taking them more or less in order of importance, first may be mentioned inflammation, with symptoms of fever and wasting, then ulceration, sloughing, or abscess. In these cases the walls of the œsophagus and the neighbouring cellular tissue may be alone involved. In some cases the surface lesion has led to septicæmia and pyæmia.

<sup>1</sup> *British Medical Journal*, 1895, vol. i. p. 978.

Ulceration may extend deeply and lead to perforation of the pleural or pericardial cavity, with symptoms of purulent inflammation of these cavities. In a case reported by Silver<sup>1</sup> death resulted from acute pericarditis, the result of swallowing false teeth. At the post mortem three or four teeth and the plate were lodged partly in the œsophagus and partly in the pericardial cavity. Again, if the body be sharp pointed, it may itself be the direct means of perforating these cavities, and their contained organs, the heart and the lungs. Similarly perforation may take place into the trachea or left bronchus, producing violent respiratory symptoms. The spinal cord may be wounded. In cases of moderate hæmorrhage the bleeding may come from œsophageal vessels or a thyroid branch; in the severer cases one of the large vessels may be opened, such as the aorta, either vena cava, the innominate, the common carotid, the right subclavian, or the pulmonary artery. Should the body be finally ejected by abscess formation bursting on the surface of the body, fistulæ may remain or œsophageal stricture result.

In illustration of some of these complications the following brief abstract of cases may be given.

CASE VIII.—*Impaction of a piece of meat in the œsophagus, and death from abscess causing dyspnœa.*

Mrs. H., when at supper, swallowed a piece of gristle, with meat attached. It was described as being about one inch long and half an inch in diameter. The symptoms were pain and sense of obstruction referred to a point corresponding to the upper part of the sternum. A feeling of uneasiness, which later became pain, existed over the spinous process of the first dorsal vertebra. There was dysphagia which amounted to a total inability to swallow solids, and fluids only passed slowly and in small quantities, with the appearance of great muscular effort. Pulse 110; skin moist; expression of face anxious; no difficulty in breathing. Emetics were tried ineffectually. On the following day a probang was passed, and after its withdrawal the patient felt at once relieved. The symptoms, however, still continued. On the third day there was feeling of chilliness, with fever; neuralgic pain in the teeth and lower jaw; expectoration streaked with blood. On the seventh day the patient suffered from severe attacks of dyspnœa. Pulse 120; respiration 20. Breathing stridulous, with a somewhat croupy cough. Swallowing induced an attack of dyspnœa. A slight bulging was found on both sides of the neck, but no

---

<sup>1</sup> *New York Medical Journal*, 1891, vol. liv. p. 609.



evidence of fluctuation. The patient died from a severe attack of dyspnoea. At the post mortem the œsophagus was found to present signs of inflammation on its inner surface. Behind, an abscess was found extending from the fourth cervical vertebra to the second dorsal below. It contained about four ounces of pus. No foreign body was discovered. (Van de Wasker, 'New York Med. Journ.' April 1871, vol. xiii. p. 453.)

CASE IX.—*Perforation of the œsophagus by a fish bone. Post-œsophageal abscess, and death from pyæmia.*

A woman was admitted into the fever ward suffering from what was supposed to be typhus. Subsequently it was ascertained that a fish bone had been swallowed some days before, but a surgeon to whom the patient at this time applied told her it had been removed, and she herself was of the same opinion. The symptoms were in the main those of double pneumonia, with a peculiar laryngeal cough. The weakness of the patient did not permit of much examination nor of active treatment. She died forty-eight hours after admission. The post mortem showed that the bone had passed quite through the back wall of the œsophagus. It was found imbedded in pus in front of the vertebral column. Pus was found in the pleuræ, in the lungs, and in the pericardium. (Prof. W. T. Gairdner, 'Edin. Med. Journ.' 1859, vol. iv. part 2, p. 769. See also a case by Church in 'St. Bart.'s Hosp. Reports,' 1883, vol. xix. p. 51.)

CASE X.—*Impaction of a mass of meat, and perforation of the œsophagus by a piece of bone. Extensive emphysema and death.*

D. G., aged 50, admitted suffering from severe dyspnoea. While eating his dinner a piece of beef became impacted. He suffered much pain at the time. He was unable to swallow anything but a little water. His breathing soon became difficult. An endeavour was made to push down the mass, but without effect. The pain grew worse in the evening, and he noticed that his neck and face had commenced to swell. The following day his symptoms had increased; the emphysema was more extensive, the breathing was strident, his voice was low and husky, and he had a short gasping cough. Later in the day, owing to the severity of his symptoms, he was tracheotomised, with the result that he obtained much relief. On the morning of the third day the patient stated he had passed a very good night, that his breathing was no longer troublesome, and that the mass had passed down his œsophagus all right. He had taken afterwards half a pint of beef tea. He remained well throughout the day, but towards night he became weak, and weakness increasing he died early the next morning—on the fourth day. At the post mortem it was found that the posterior mediastinum contained over a pint of fluid, which was made up apparently of tea and beef tea. No orifice was found in the trachea except that made at the operation. In the œsophagus a mass of beef and fat was found, and projecting through the wall a small bone, sharp at both ends and transfixed obliquely. One end of the bone perforated the wall, and connected with it and continuing upwards was a

slit or tear of one centimeter in length. It was through this opening that the fluids had escaped and through which the air had passed during the convulsive efforts of the patient. (William Thomson, 'Trans. of the Royal Acad. of Med. in Ireland,' 1886, vol. vi. p. 115.)

CASE XI.—*Perforation of the aorta by a piece of bone impacted in the œsophagus. Death from hæmorrhage.*

A man while eating a chop swallowed a piece of bone. Pain was experienced afterwards in swallowing, but medical aid was not sought until the third day. Examination with the finger and the horsehair probang—the latter being passed the whole length of the œsophagus—failed to detect any foreign body. Six days after the accident the patient was feeling better, but the pain on swallowing had not entirely ceased. On the seventh day, in the morning, he expectorated a small quantity of blood, and about midday a large quantity of arterial blood was thrown up, and death followed immediately. At the post mortem a perforation was found on each side of the œsophagus at the same level, that on the left side piercing the aorta an eighth of an inch above the first right intercostal branch. (Williams, 'Brit. Med. Journ.' 1892, vol. i. p. 277. See also similar cases in 'Brit. Med. Journ.' 1879, vol. ii. p. 732; 'Trans. Path. and Clin. Soc. Glasgow,' 1892, vol. iii. p. 27; 'Journal of Laryngology and Rhinology,' 1891, vol. v. p. 116.)

CASE XII.—*Perforation of the œsophagus by an impacted fish bone. Death from injury to the heart.*

A man aged 59 ate while intoxicated some fish. The next morning he complained of pain in the throat, as if something were sticking there, and he suffered from dysphagia. During the day he followed his usual occupation and carried a basket of fruit weighing some thirty pounds for some distance. Suffering considerable pain in the throat and chest, he went in the evening to the nearest hospital, where a dilating horsehair probang was passed. On leaving the hospital the man was extremely faint and ill, and complained of severe pain in the chest—as he expressed it, 'in his heart.' This pain increased, and he vomited nearly all food. On the third day after that on which he went to the hospital the pain had slightly diminished, but the vomiting continued. There was no difficulty in breathing. Late in the evening he got out of bed, stood upright and spread out his arms, stretching himself. He suddenly staggered; his wife ran to support him, when he immediately expired. At the post mortem it was found that a lance-shaped fish bone, about two inches long, had penetrated the anterior surface of the œsophagus about a quarter of an inch above the cardiac orifice. It passed through the diaphragm and pericardium, wounding the wall of the left ventricle. The pericardial cavity was fully distended with sanious serum, and contained some blood clot. Death was evidently due to syncope from embarrassment of the heart's action by the pericardial effusion. (Eve, 'Clin. Soc. Trans. Lond.' 1880, vol. xiii. p. 174.)

In this case it is interesting to note that the man's worst symptoms all seemed to date from the passage of the probang, and such being the case, one is forced to the unpleasant conclusion that the endeavour to do good had been the means of accelerating, if not possibly actually causing, the death of the patient.

CASE XIII.—*Impaction of a fish bone in the œsophagus : perforation of an intervertebral substance and injury to the spinal cord.*

A fish bone had accidentally been swallowed by an infant. A careful examination failed to detect it. The child gradually wasted away, and when it died at the end of some months, it was found that the fish bone had passed through the intervertebral substance and wounded the cord. (Morell Mackenzie, *op. cit.* vol. ii. p. 192. See also a similar case in the 'Trans. Path. Soc. Lond.' 1853, vol. iv. p. 27.)

**Diagnosis.**—From the symptoms described and the cases quoted it will be seen that much latitude exists in the degree of certainty which can be attached to any supposed case of impaction of a foreign body in the gullet. While on the one hand no difficulty whatever may be present, on the other it may be quite impossible to say whether the body is still impacted or has been dislodged. Whenever it is possible to obtain reliable information of the occurrence of the accident, considerable assistance is lent towards making a diagnosis, notwithstanding the obscureness of the symptoms otherwise. In the case of young children and insane people, the symptoms are often the only indication, and if these be not distinctive the diagnosis, if not impossible, may be very difficult. As regards the seat of impaction, information may be obtained from other sources than those which the patient may be able to indicate. Thus in the neck a body of sufficient size may be felt by palpation. Lower down, auscultation over the spine may prove of service; the sound produced by the impact of fluid in deglutition indicating both the existence and the seat of obstruction. Better still, the passage of a bougie or sound which will give evidence of some hindrance to its passage. Where a 'knobbed' bougie is used, the metal or ivory knob may be heard to strike the body. Œsophagoscopy has in many instances proved of value. Thus Von Hacker<sup>1</sup> is reported to have seen by the aid of the panelectroscope an irregular

<sup>1</sup> *Annual of the Universal Medical Sciences*, 1890, vol. iv. F—27.

fragment of bone impacted in the gullet just above the bifurcation of the trachea, and detached it by appropriate screwing motions. This surgeon has more recently reported the results of a large number of examinations effected by means of the Mikulicz-Leiter electro-endoscope, with special regard to the detection of foreign bodies. An abstract of these will be found in the 'Journal of Laryngology.'<sup>1</sup> Morell Mackenzie<sup>2</sup> also quotes a case in which he was enabled to detect a flat lamella of bone on the anterior wall of the œsophagus, about two inches below the cricoid cartilage. It was easily removed by forceps.

It must be remembered that even in cases where no doubt exists as to the occurrence of such an accident and marked symptoms are present, yet difficulties may stand in the way of an accurate diagnosis. For on the one hand there may be no obvious sense of obstruction felt by the patient, and the passage of a bougie may also fail to detect the impacted body. Again, a body may be successfully pushed on into the stomach, without any immediate abatement of the symptoms.

It is impossible to over-estimate the value which attaches to the use of the 'new photography' in the detection of foreign bodies impacted in the œsophagus. Not only will much of the past difficulty disappear in the certainty with which the existence of a foreign body will be verified, but the whole subject of treatment will become simplified by the knowledge of the shape, situation, and lie of the object. Probably the first case published illustrative of its value from a diagnostic point of view is that of H. Rutherford and J. MacIntyre,<sup>3</sup> of Glasgow. The patient had swallowed a halfpenny six months before, and the pain felt was referred to the left of the epigastrium. On examining by means of the fluorescent screen, the author could easily see the round black shadow of the coin at the level of the third dorsal vertebra. The case was also photographed (see Plate II, fig. 2), but the foreign body could as easily be seen by the eye through the cryptoscope or fluorescent screen.

**Prognosis.**—The many possibilities which exist as long as

<sup>1</sup> 1895, vol. ix. p. 284.

<sup>2</sup> *Op. cit.* vol. ii. p. 193.

<sup>3</sup> *Brit. Med. Journ.* 1896, vol. i. p. 1094. See also J. William White for similar case. *Annals of Surgery*, 1896, vol. xxiv. p. 238.

PLATE II.

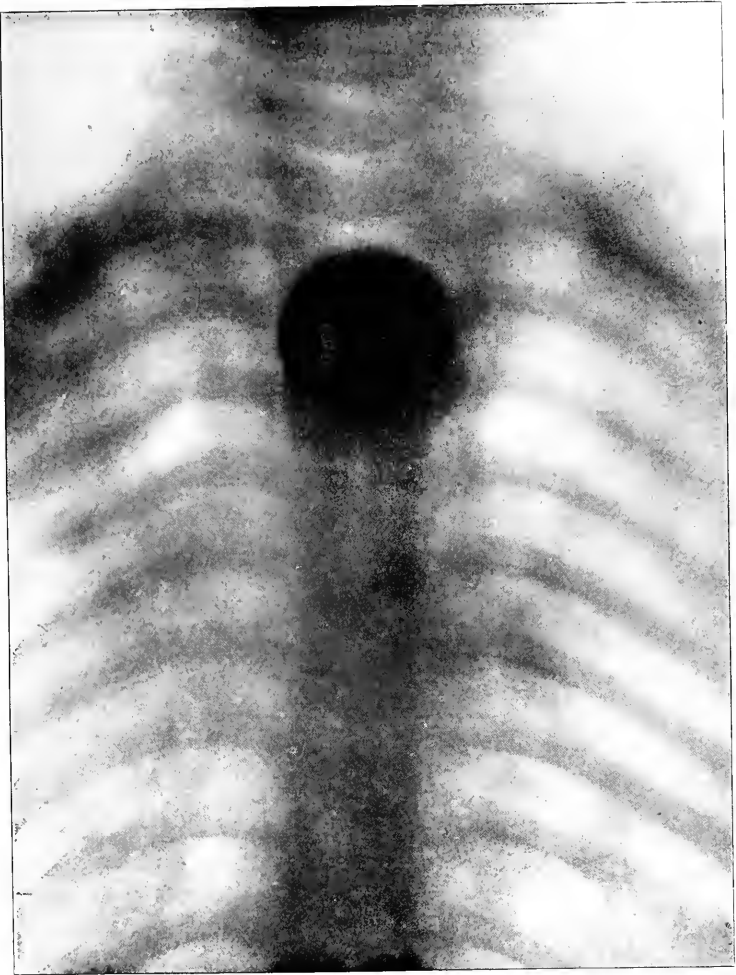

Fig. 2.—A half-penny impacted in the œsophagus. (From a Skiagraph taken by Dr. John Macintyre, Glasgow.)



a body remains impacted in the œsophagus render it impossible to say what may be the ultimate result in any one case. The first considerations of importance are the nature of the impacting body and the urgency of the immediate symptoms. As a rule there is a direct relation between these two conditions. The larger, harder, and more irregular the substance impacted, the graver will be the symptoms, and if in these severer cases immediate relief is not afforded by removal of the body, a fatal result rapidly ensues. A successful dislodgment, however, of the obstructing material is quickly followed by complete abeyance of all symptoms. The exceptions to this latter result are those comparatively rare cases of rupture of the œsophagus<sup>1</sup> occurring at the time of ejection of the body. When the symptoms are not urgent at the first, the prognosis again turns upon the nature of the impacting body and whether it is likely to be dislodged by operative measures or by natural processes. The more a substance approaches something which is likely to stick into the walls of the gullet, the less, speaking generally, is the chance of its removal either naturally or by operation. Again, the longer such a body remains impacted the graver becomes the prognosis. The cases already quoted sufficiently indicate the gravity of prolonged lodgment of these sharp-pointed bodies. While therefore it must always give cause for anxiety as long as bodies of this description are within the œsophagus, nevertheless not a few cases are now on record showing that, at periods of variable length from the date of the accident, dislodgment has taken place and complete recovery resulted. In a case recorded by Lennox Brown,<sup>2</sup> a toothplate which had been impacted for three and a half years, and had given rise throughout to gradually increasing difficulty in swallowing, was successfully removed by means of a coin catcher. It should, however, be stated that where nature has been the means of gradually loosening and finally dislodging the body the latter has been rather of the nature of a rounded than a pointed substance.

The loosening of the body, and its dislodgment, result either from some relaxation of spasm or from ulceration,

<sup>1</sup> See page 11.

<sup>2</sup> *Journal of Laryngology and Rhinology*, 1892, vol. vi. p. 365.

after which it may pass down into the stomach, or be ejected through the mouth in a sudden violent attack of retching. In other cases it becomes the nucleus of an abscess, which, bursting externally, is discharged. Again, sharp-pointed bodies such as pins and needles have worked their way harmlessly through the tissues and been finally extracted from beneath the skin. Lastly, the body may become encysted and remain perfectly inert throughout life.

The following abstracts of cases may be given in illustration of some of the natural processes of repair :

CASE XIV.—*Impaction of a coin in the œsophagus: expulsion by the mouth after four months.*

A boy aged 4 years while playing with some money swallowed a halfpenny. An emetic was given without effect. He was very sick, cried a great deal, and complained of pain which he located about the middle of the sternum. He looked ill and lost his appetite. He was very restless both day and night. Some days later he appeared to be quite well, his appetite was good, but he still complained of pain about the middle of the sternum, which was increased on swallowing anything semi-solid. After a few weeks the child lost the pain, and forgot all about the halfpenny. Four months after, while munching some cake, he hiccupped violently and was surprised to find that he had brought up the coin, which had turned quite black. (Doyle, 'Lancet,' 1888, vol. ii. p. 911.)

CASE XV.—*Impaction of a toothplate in the œsophagus: expulsion by the mouth after fifteen months.*

T. H., aged 28, awoke in the night feeling his toothplate slipping into his throat. It passed beyond his being able to eject it, and became impacted at the top of his gullet, where it could be felt. The patient was nervous and excited, he frequently retched and expectorated blood-stained saliva. Dyspnœa and dysphagia were marked. The forceps grasped the plate, but in attempting to extract it the dyspnœa increased and the struggling of the patient caused them to lose their hold. A second attempt similarly failed. Probangs were passed into the stomach without meeting with any obstruction; the patient was watched for a few days and then discharged, the dyspnœa and dysphagia having disappeared. A few weeks afterwards he was again suffering from dyspnœa, had a hard frequent cough, and was expectorating copiously a tenacious mucus tinged with blood. This symptom continued, until one day, fifteen months after the accident, he felt worse than usual, and after a violent fit of retching he felt something in the back of his throat. By means of his thumb nail he hooked out the false teeth. (Bridgeman, 'Lancet,' 1887, vol. ii. p. 612.)



CASE XVI.—*Impaction of a toothplate in the œsophagus: expulsion per anum five months afterwards.*

The patient swallowed a small toothplate with two teeth during sleep. Three weeks afterwards he consulted his doctor and an endeavour was made to remove it. It was felt by the probang about ten inches down the gullet, but two attempts to dislodge it failed. The patient declined operation. He returned three weeks later, when it was found that the plate had spontaneously moved to eleven and a half inches. A day or two after it had gone to thirteen inches, at which place it remained for three weeks. It then moved another inch, and fixed itself at fourteen inches for a month. Finally it moved to fifteen and sixteen inches at intervals of a day; and at last was pushed on into the stomach, after having given rise to some hours of severe pain. It ultimately passed *per anum*, having sojourned in the gullet for five months. (Hardie, 'Brit. Med. Journ.' 1881, vol. i. p. 276.)

CASE XVII.—*Impaction of a five-centime piece in the œsophagus. Death from scarlet fever twenty months afterwards. Coin found partially encysted.*

A child 7 years old was admitted into the hospital complaining of pain in swallowing and located at a spot on a level with the lower part of the thyroid body. It was stated that eighteen months previously she had swallowed a halfpenny, and that for the last few weeks she had been constantly vomiting and unable to keep anything down. At the time of admission she could swallow milk naturally. The patient got on very well, and took food without sickness. She was, however, attacked with scarlet fever, from which she died. At the post mortem the coin, but little changed, was found lodged in a cavity situated between the posterior wall of the trachea and the anterior wall of the œsophagus. The cavity was lined by a smooth membrane, and opened above into the œsophagus by an orifice which left about one-third of the coin exposed. (Sharkey, 'Trans. Path. Soc. Lond.' 1884, vol. xxxvi. p. 190.)

CASE XVIII.—*Impaction of a chestnut in the œsophagus. Death from acute phthisis fourteen months afterwards. Chestnut found encysted.*

M. L., æt. 38, a lunatic, swallowed a chestnut with the object of putting an end to her life. Her symptoms showed no acuteness. She refused for three days to take any food, except water, which she swallowed with apparently the greatest difficulty and pain. Nothing was detected externally, but on attempting to pass a tube it could not be got any further than the entrance of the œsophagus. A thorough examination was made under chloroform. The day following she took milk, but still with apparent difficulty. After this she ate bread, and from henceforward began to improve and take both solids and fluids. In March of the following year acute phthisis developed, and she died about fourteen months after swallowing the chestnut. At the post mortem both lungs were studded with miliary tubercles. On opening the œsophagus the chestnut

was found in a perfect state of preservation, lying on the fifth and sixth cervical vertebræ, where it had made a pocket for itself. (Courtenay, 'Journal of Mental Science,' 1888-89, vol. xxxiv. p. 539.)

**Treatment.**—In discussing the treatment to be adopted in the removal of foreign bodies from the œsophagus, the considerations connected with it may be said to be on a par with those connected with the diagnosis of the seat of impaction and the nature of the impacted body. The more accurate the knowledge of the body and its connections, the easier becomes the choice of the most suitable method for its removal, and the more likely is success to follow. The treatment therefore to be adopted in any case depends largely upon facts ascertained with regard to it. Without some such consideration between cause and treatment, operation may do more harm than good. As illustrating how simple a measure may bring about even a fatal issue see Case XII. already quoted, where it will be found that the passage of a hair probang led apparently to the perforation of the heart by a fish bone. Every case therefore has to be treated on its own merits, and may call for special ingenuity on the part of the operator to adopt measures suited for the case under consideration. As then it is not possible to state any general method that should be adopted in every case, I shall simply describe the various measures that are in use, and indicate such few as exist for dealing with special cases.

**Use of an anæsthetic.**—The question of the administration of an anæsthetic will sometimes arise. It has both its advantages and disadvantages. In the case of children an anæsthetic admits of a more careful examination of the œsophagus, and of the adoption of any of the milder measures for the removal of the obstructing agent. In adults it removes, what is sometimes of much assistance, the help that the patient is able to give; and it also entails the patient being in a recumbent position. The question of the giving of an anæsthetic is more or less determined by the amount of resistance which the patient is likely to offer to measures adopted either for diagnosis or treatment.

**Various methods of treatment:** 1. *By manipulation.*—Should the body be lodged in the cervical portion of the œsophagus and be of a soft nature, it may be possible to alter its shape so as to admit of its being ejected. Or, again, it may be

possible, by manipulating it, to work it upwards or downwards. As the finger cannot reach usually beyond the cricoid cartilage, little good can be effected by internal manipulation. An interesting, though somewhat exceptional, measure was adopted by Taylor of Hathersage, who, in the case of a pin in the œsophagus, induced a little girl with small hand and arm and long tapering fingers to pass her hand down the canal, when she succeeded in detecting the pin and removing it.<sup>1</sup>

2. *By administration of solid food.*—In cases of such bodies as fish bones, pins, &c., which do not prevent deglutition, it is sometimes possible to dislodge them by the administration of solid food. The patient should be induced to swallow reasonably large pieces of partially masticated dry crusty bread or masses of mealy boiled potatoes.

3. *By emesis.*—Some judgment needs to be exercised in deciding whether a patient should be induced to vomit or not. Where it is thought likely that the impacting body might perforate the walls of the œsophagus no vomiting should be encouraged. On the other hand, in the case of articles of diet not likely to injure the canal, and which have not already led to retching or vomiting, an emetic may be tried. The consensus of opinion, however, amongst most surgeons is against the use of emesis, and at most it should receive a very limited and guarded application.

Emesis may be effected in one of four ways :

First, by administration of an emetic by the mouth. This naturally can only be accomplished when obstruction is not complete and deglutition is possible. The following illustrates a successful case :

CASE XIX.—*Impaction of a piece of bone in the œsophagus : ejection of the bone by induction of vomiting.*

A lady had swallowed a piece of bone with some soup. She was seen twenty hours afterwards in great distress, and quite unable to swallow anything. The obstruction was quite beyond reach. An emetic consisting of half a drachm of sulphate of zinc was administered. This having no effect, a second dose was given and vomiting immediately occurred. There was discharged through the mouth a piece of mutton bone quite an inch long and having four sharp corners and edges. (Glover, 'Brit. Med. Journ.' 1884, vol. i. p. 561.)

---

<sup>1</sup> Solis-Cohen, *Annual of the Universal Medical Sciences*, 1888, vol. iii. p. 327.

Second, by an enema. An infusion of tobacco, in a case quoted by Poulet, was successful in causing the ejection of a piece of sheep's lung which had given rise to serious symptoms.

Third, by subcutaneous injections. Both tartar emetic and hydrochlorate of apomorphia have been used with success. Doses of  $\frac{1}{2}$  grain of the former and  $\frac{1}{25}$  to  $\frac{1}{10}$  grain of the latter may be given.

CASE XX.—*Impaction of the heart of a bird in the œsophagus: subcutaneous injection of  $\frac{1}{2}$  grain of tartar emetic: ejection of the substance by vomiting.*

A lady aged 32, whilst partaking of a giblet pie, was suddenly seized with a choking sensation, together with difficulty of breathing. The patient was unable to swallow fluid. The probang indicated an obstruction five or six inches from the mouth. Vomiting was encouraged by the administration of mustard and water and by tickling the fauces with a feather, but in both cases without effect. Later, owing to an increase of symptoms and an urgent desire to have something done, 10 minims ( $\frac{1}{2}$  grain) of the tartrate of antimony solution was injected into the left arm. In less than two minutes a sensation of sickness was produced, and almost immediately afterwards a sudden fit of vomiting came on, which had the effect of expelling a perfect specimen of the heart of a bird. The patient was at once relieved. (Dodd, 'Lancet,' 1885, vol. ii. p. 713.)

CASE XXI.—*Impaction of a piece of bone in the œsophagus: subcutaneous injection of  $\frac{1}{20}$  grain of apomorphia: ejection of the bone by vomiting.*

A strong Irish woman, after a hearty meal of mutton stew, vomited a little blood and felt a sharp pain in her throat, especially with inspiration or swallowing. On external examination of the neck something could be felt to grate and move a little just behind the cricoid cartilage. The subcutaneous injection of apomorphia ( $\frac{1}{20}$  grain) caused vomiting in eight minutes, with the relief of all symptoms and the removal with the vomit of a piece of sheep's rib an inch and a half long and half an inch wide. (Preble, 'Boston Med. and Surg. Journ.' 1885, p. 107.)

Fourth, by mechanical measures. Perhaps one of the best means for inducing vomiting, and one which was strongly advocated by Syme, is to irritate the back of the throat with a feather. In the case of young children it is a very good plan to turn the child on to its stomach, allow the chest to rest upon a pillow, and then insert the finger into the back of the throat. The child then retches, and the foreign body coming up into the back of the pharynx, drops down out of the mouth. Coins

and such like bodies are often effectually got rid of in this way.

4. *By solvents.*—It has been found possible in some cases of obstruction from large masses of food to cause a certain amount of artificial digestion of the substance, whereby it has become so softened that its dislodgment has been effected. For the purpose pepsine has been given. A successful case is quoted by Solis-Cohen<sup>1</sup> of a child 3 years of age, who had a stricture the result of drinking some lye eighteen months previously. The removal of the foreign body was facilitated by preliminary softening with digestive mixture.

5. *By probang, bougie, or coin catcher.*—The most serviceable kind of probang is that known as the bristle probang, or, as it is sometimes termed, the horsehair parasol. It is fitted with a piece of sponge at the extremity, and the bristles are capable of being expanded into a parasol-like shape (fig. 3).



FIG. 3.—BRISTLE PROBANG

This instrument can be used either with the object of forcing the obstacle on into the stomach, or, as is more frequently the case, for extracting it by the mouth. In the first instance the probang will not pass by the obstruction, while in the second it must do so. In the passage of a probang or bougie a few anatomical points should be borne in mind. As the result of measurements taken in fifty-five subjects, Maurice H. Richardson showed that 'the distance from the upper incisors to the opening in the diaphragm when the head is thrown back is not constant. The average distance is fourteen and a half inches. There is also no constant ratio between the height of the individual and the measurement. If, however, the individual is of average height and with a neck of ordinary length, it is safe to say that the distance from the incisors to the diaphragm is about fourteen and a half inches. If the probang is arrested at a point more than thirteen inches from the incisors, the point of obstruction is probably at or near the cardiac end of the œsophagus.'

<sup>1</sup> *Annual of the Universal Medical Sciences*, 1888, vol. iii. p. 326.

If the probang passes by the obstruction, the parasol is then expanded and withdrawn. In using a probang for propulsion purposes, it must be remembered that the endeavour is not free from danger. Cases are recorded of serious and even fatal results from the forcible use of the instrument. The following is a brief abstract of such a fatal case.

CASE XXII.—*Rupture of the aorta, the result of an endeavour to force onwards, by means of a probang, a toothplate impacted in the oesophagus.*

Sir Andrew Clark, at a meeting of the Clinical Society of London, instanced a case of Syme's in which a man had swallowed a toothplate, and in forcibly pushing it on by means of a probang, the surgeon accidentally ruptured the aorta. A rush of blood immediately took place and speedily led to the death of the patient. ('Brit. Med. Journ.' 1884, vol. i. p. 561.)

The remarks made regarding the use of the probang equally apply to the employment of the bougie. It may be useful to remember that when propulsion suggests itself as feasible, other means more readily at hand may be used in place of the proper bougie. Thus the stem of a leek has proved effectual; also a whip handle. The coin catcher (fig. 4) is more especially fitted for the purpose which its name suggests, although it sometimes is of service for the extraction of other objects.



FIG. 4.—COIN CATCHER

Difficulties sometimes arise in withdrawing both the probang and the coin catcher. Such happen from the locking of the instrument with the foreign body. In accidents of this nature the instruments should be pushed down again and some slight rotatory movement adopted, when another attempt may be made at withdrawal. In no case should force be used, and when all reasonable endeavours fail at withdrawal, oesophagotomy will have to be performed.

6. *By forceps.*—The kind of foreign body for which the forceps is best suited is that which is too large and too fixed to be extracted by the probang. It is limited also in its use—in the simpler forms—to obstacles situated nearer the upper than the lower end of the gullet. In using the forceps, it should be

remembered that the body to be extracted has to be drawn up through the narrower part of the canal opposite the cricoid cartilage, and therefore no force should be exercised if a hitch takes place at that point.

Various kinds of forceps will be found depicted in the text-books, many somewhat complicated both in their construction and in their use. The simplest, and for all practical purposes the best, is the long-shanked œsophageal forceps with a slight bend near the biting portion (see fig. 5). This instrument can only remove bodies from near the upper end, and it is a question whether with the more complicated forceps, made so as to

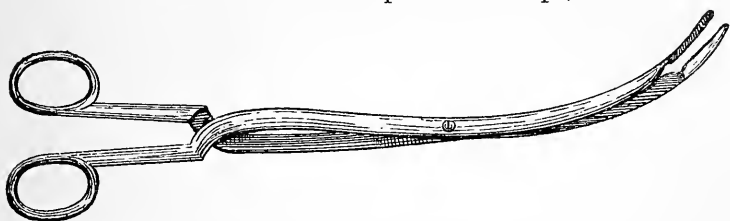

FIG. 5.—ŒSOPHAGEAL FORCEPS WITH PERPENDICULAR CURVE

reach farther down the canal, it is wise to withdraw a body that is impacted in the lower part. For although it might thus be removed without injury to the canal, less risk would probably be run by gently pushing it on into the stomach, or by opening the œsophagus in the neck and attempting extraction through the wound. In some cases it has been found possible to loosen the impaction of the body by dilating the œsophagus either above or below the seat of obstruction. For this purpose a large-sized dilator—such as is used, and will be described later, for stricture—may be passed down to the obstruction. Elastic bags, capable of inflation either by air or water, have been used for the same object, and on one occasion with success.<sup>1</sup> In using the forceps a gag is necessary, and care should be taken to see that it is securely fixed. Annandale<sup>2</sup> reports two cases in which difficulty occurred in attempting to extract the foreign body, on account of the gag slipping just as the body was opposite the orifice of the larynx. Great respiratory trouble at once ensued, until the mouth was forcibly opened and the body extracted.

<sup>1</sup> Gautier, quoted by Poulet, *On Foreign Bodies in Surgery*, vol. i. p. 116.

<sup>2</sup> *Liverpool Medico-Chirurgical Journal*, 1881, No. 1, p. 18.

7. *By adhesive substances.*—A very simple and effectual method of extracting small bodies has been practised with success by Créquy.<sup>1</sup> He recommends ‘tangling up a skein of thread and tying it in the centre with a strong thread forty to fifty centimeters long, covering the mass with some agreeable confection and letting the patient swallow it; as soon as it is supposed to have passed the foreign body it is drawn out.’

8. *By special means for particular cases.*—The removal of a fish hook which has ‘caught’ the walls of the gullet calls for a special method for its extraction. In all the cases recorded the hook has been accidentally swallowed while still attached to a piece of thread or gut; and it is this latter which constitutes the chief aid in the process of extraction. The plan is to pass the line attached to the hook through either a solid substance or a long hollow bougie. In the former case the weight of the substance, when it has slipped down to the hook, dislodges it; and in the latter, as soon as the hollow bougie reaches the hook, the force applied in pushing it on causes the hook to be withdrawn. Two cases quoted by Morell Mackenzie<sup>2</sup> illustrate the success attending each of these methods. The substance used in one case was a lead ball twice the diameter of the hook; in the other it was a full-sized hollow œsophageal bougie. The following illustrates a case successfully treated by Syme:

CASE XXIII.—*Extraction of a fish hook impacted in the œsophagus.*

A boy in the excitement of fishing swallowed a three-barbed hook he was holding in his mouth. A wire was attached to the hook. Professor Syme adapted a wooden ball to fit the barbs, and, passing it along the wire, succeeded in breaking away the points, after which the hook was easily removed and recovery ensued. (Duffin, ‘Brit. Med. Journ.’ 1884, vol. i. p. 561.)

9. *By œsophagotomy.*—Failing every endeavour to extract the body by the mouth, the question of operation will arise. The points to be considered will be the nature of the body—its size, consistency, and contour; its position; the urgency of the symptoms; and the remote possibilities, whether it may by natural processes become dislodged or whether it may give

<sup>1</sup> Solis-Cohen, *Annual of the Universal Medical Sciences*, 1889, vol. iv. G—36.

<sup>2</sup> *Diseases of the Throat and Nose*, vol. ii. p. 194.



rise to dangerous complications. It will thus be seen that the question of operation may be one of considerable difficulty to decide. The feeling among surgeons nowadays is rather to operate than delay when in doubt, and the success which has attended operative interference adds further encouragement in that direction. Professor Krönlein<sup>1</sup> has operated successfully in five cases out of six. In the case of a child aged 3 years which had swallowed a halfpenny, I preferred to perform external œsophagotomy to attempting to pull the coin up by the natural ways. As it was, the coin was so tightly impacted, or the muscles so closely contracted upon it, that much force was required to extract it with a pair of dressing forceps through the œsophageal wound. It is probable that many a large body will pass down the œsophagus without injuring the walls, because its progress is helped by the natural downward contraction of the constrictor muscles and the circular muscular fibres of the gullet; but when an attempt is made to pull the body up, the same muscles which helped it on now impede its return; and hence, while the mucous membrane escaped any injury in the downward course of the object, it is liable to be lacerated—and possibly the other tunics also—in its forcible extraction upwards. Much more does this reasoning apply to hard, irregularly shaped bodies, which are much more likely to produce serious injury to the walls of the gullet than coins and suchlike objects. It is useful to remember that the finger inserted into the œsophagus at the cervical wound can reach the arch of the aorta, and even hook the finger under it in some cases (Maurice H. Richardson).<sup>2</sup> Thoracic œsophagotomy has been suggested for cases of impaction below the reach of the cervical operation.

10. *By gastrotomy.*—In cases where the body has become impacted at the lower end of the gullet, and its removal is considered imperative, it can be successfully reached through the stomach. Brief extracts of two interesting cases are given in which this measure was adopted successfully. In the first case the body was withdrawn through the mouth; in the second it was removed through the stomach.

<sup>1</sup> *Annals of Surgery*, 1894, vol. xx. p. 567.

<sup>2</sup> *Boston Med. and Surg. Journ.* 1896, vol. cxv. p. 568.

CASE XXIV.—*Impaction of a peach stone in the œsophagus : successful removal through the mouth by the aid of gastrotomy.*

A boy aged 4 years had a peach stone impacted in his gullet at a distance of thirteen inches from his teeth. After opening the abdomen an incision an inch and a quarter long was made into the stomach; through this the index finger was inserted and passed into the œsophagus, where the stone was felt. A slender bougie was then inserted through the stomach into the œsophagus, past the foreign body, and out of the mouth. A piece of sponge was fastened to the lower end of the bougie, and on the withdrawal upwards of the latter, the stone was extracted. (Wm. T. Ball, quoted by Solis-Cohen, 'Annual of the Universal Medical Sciences,' 1888, vol. iii. p. 328.)

CASE XXV.—*Impaction of false teeth in the œsophagus : successful removal through the stomach by the aid of gastrotomy.*

A man aged 37 swallowed his false teeth while eating. A small ivory probang detected the body easily, situated far down, apparently near the stomach. Every method at removal failing, the man readily consented to the proposed operation. After opening the abdomen, an incision an inch and a half long was made into the stomach. Through this opening an endeavour was made with instruments to extract, but failing, the incision was enlarged, and the hand and forearm inserted into the stomach. The middle and index fingers were then passed up the œsophagus between the heart in front and the aorta behind, till the body was felt and its bearing ascertained. A little careful manipulation with the index finger loosened the body, and it then easily came away. The patient made an excellent recovery. (Maurice H. Richardson, 'Boston Medical and Surgical Journal,' 1886, vol. cxv. p. 567. See similar treatment in a case of Finney, 'Annals of Surgery,' 1893, vol. xvii. p. 228.)

---

## CHAPTER IV

INFLAMMATORY AFFECTIONS OF THE ŒSOPHAGUS: ACUTE TRAUMATIC ŒSOPHAGITIS; ACUTE IDIOPATHIC ŒSOPHAGITIS; ŒSOPHAGITIS OF CHILDREN; MEMBRANOUS OR PELLICULAR ŒSOPHAGITIS; APHTHOUS ŒSOPHAGITIS; CHRONIC ŒSOPHAGITIS; PHLEGMONOUS ŒSOPHAGITIS; SUBMUCOUS ŒSOPHAGEAL ABSCESES; CATARRHAL ŒSOPHAGITIS; FOLLICULAR ŒSOPHAGITIS; CROUPOUS ŒSOPHAGITIS

ARISING from whatever cause, œsophagitis is a comparatively rare disease. It is most commonly met with as an involvement of inflammation of the pharynx or stomach. Whatever may be the general symptoms present in these cases,

those connected directly with disease of this particular part are as a rule more or less masked by the symptoms arising from the affection of the other regions. Treatment, therefore, has reference often rather to these latter than to the former. Again, it may be said that inflammatory affections of the œsophagus will more frequently fall to the hand of the physician for treatment than the surgeon. Occasionally, however, either as an immediate result of the inflammation or as an after effect, symptoms may arise calling for surgical treatment. I propose therefore to refer briefly to these various inflammatory conditions. It is doubtful how far one is right in speaking of these different affections as various forms of inflammation. It is quite possible, and indeed probable, that differences are due more to the degree or intensity of the inflammation than to its kind. This view has been strongly advanced by Jonathan Hutchinson,<sup>1</sup> and it would seem more than likely that the cause of the disease determines the intensity of the inflammation, rather than any special peculiarity in its manifestation. Any one cause may induce either a slight or a severe attack, and the appearances and symptoms will correspondingly vary.

**Acute traumatic œsophagitis.**—Acute inflammation as the result of injury is the form most commonly met with. It may arise as the result of mechanical injury, as in the impaction of a foreign body; as the consequence of a sting of an insect, as in the case of a wasp accidentally swallowed; or, as is most commonly the case, as the result of swallowing some powerful irritant.

**Symptoms.**—In the case of the imbibition of caustics or corrosives, it very commonly happens that the symptoms arising from the injury to the parts above and below mask those which would otherwise indicate involvement of the gullet; but when sufficiently pronounced to assert themselves, they will be found to consist mostly in a burning sensation felt down the neck and in the chest, pain to a variable extent, tenderness on palpation of the gullet, and more or less pain at any endeavour to swallow. In the case of stings of insects, or impacted foreign bodies, the inflammation may be of a more local character. Pain may be referred to a particular point

<sup>1</sup> *Brit. Med. Journ.* 1892, vol. ii. p. 881.

either behind or in front, above or below, according to the locality of the mischief, and it may be similarly localised in any attempt at swallowing.

**CASE XXVI.**—*Acute œsophagitis the result of the sting of a wasp. Recovery in nine days.*

A gentleman aged 54 swallowed a wasp, in the act of drinking some beer. He suddenly felt a very sharp pain at the episternal notch. Severe paroxysms of coughing took place, followed by vomiting. When seen about three hours after the accident, he was very anxious and faint, and complained of something in his throat, just above the sternum. He was unable to swallow. A subcutaneous injection of morphia was given, and later in the day the patient was much relieved, although still unable to swallow. On the following day he was able to swallow fluids, but not until nine days after the accident was he able to swallow solids. (Morell Mackenzie, vol. ii. p. 45.)

**Prognosis.**—The cases of stings of insects reported are too few to admit of any certain statement. It is probable, however, that the effect of a sting will vary in the œsophagus, just as much as it does when the skin is the seat of the lesion. Since in the latter it is rarely of any moment, it may be assumed that no serious result will ensue when the gullet is attacked. As regards œsophagitis due to the other traumatic causes named, the danger lies not so much in the acute condition of the part itself at the time as in the after effects. If the acute inflammation leads to ulceration, then all the troubles connected with a traumatic stricture of the canal must be expected.

**Treatment.**—Little or nothing can be done as regards the part itself. Rest being the object required, nutrition should be effected as long as possible by nutrient enemata. A little ice may be given to relieve any dry or parched feeling of the mouth. Any pain or anxiety may be overcome by subcutaneous injections of morphia.

**Acute idiopathic œsophagitis.**—To the late Sir Morell Mackenzie belongs the credit in this country of drawing attention to a well-defined, though apparently excessively rare, form of œsophagitis. In his work—‘Diseases of the Throat and Nose,’ vol. ii.—will be found an exhaustive description of the disease; and such brief notice as space will permit here, I must acknowledge as abstracted from his account. Prior to his work, it would seem that every case recorded had come from abroad;

he was himself, however, enabled to record five cases that he had seen and treated. In looking up the literature of the subject since 1884, the date of his work, I fail to find any record of cases in this country, and only one from abroad (Schech). This disease therefore must either be very rare or, as believed by Mackenzie, frequently not recognised. As regards the cause of the affection, nothing of any constant or definite character seems ascertainable. In Mackenzie's five cases, one appears to have arisen after taking several ices; a second to have been the result of alcoholic abuse; a third to have followed accidental immersion in a river; and the remaining to have occurred in rheumatic patients.

**Symptoms.**—One of the most marked symptoms is pain in the act of deglutition, which is frequently of a severe burning or tearing character. Pain of a dull aching kind is also often felt deep in the neck and chest. Tenderness is complained of on external palpation of the œsophagus; and any movement of the neck, or even the movement involved in speaking, sometimes augments the patient's suffering. Feverish symptoms exist. The patient complains of dryness of the mouth and thirst, notwithstanding the constant expectoration of frothy mucus. Delirium is sometimes present. Should the inflammation proceed to ulceration, the expectoration may become tinged with blood. The formation of an abscess may be indicated by rigors and the augmentation of the patient's symptoms.

**Diagnosis.**—While the extreme difficulty and pain in swallowing will prove positive factors in localising the disease, the absence of certain other symptoms will more largely assist in determining the diagnosis. Thus, the exclusion of any mischief connected with the pharynx or the air passages; the absence of symptoms suggestive of hydrophobia, as general hyperæsthesia, paroxysms of asphyxia, and mental aberration; the non-existence of pericarditis, which either through pain or pressure might mislead.

**Prognosis.**—In most cases the prognosis appears to have been favourable. In Mackenzie's five cases all did well. Ulceration may take place and abscess may form. Gangrene also has occurred, but it must be considered an extremely rare sequel.

**Treatment.**—Little further need be stated than has already been said in the treatment of acute traumatic œsophagitis. Warm fomentations will, when applied to the neck, sometimes afford relief. Placing the feet in hot water may be tried with advantage. Belladonna plasters applied to the back, or the liniment rubbed into the skin, will relieve pain. In four out of Mackenzie's five patients subcutaneous injections of morphia were administered with good effect.

CASE XXVII.—*Acute idiopathic œsophagitis.*

H. E., aged 23, had been upset from a boat into the water, and remained in for some time before he was taken out. He was insensible for about half an hour after being brought to shore. On the next day he was feverish, and in the afternoon felt difficulty in swallowing. Later, in attempting to swallow some soup it was violently ejected. He was slightly delirious during the night, and frequently expectorated saliva. The third day, when first seen, he was spitting up large quantities of ropy mucus. Slight inflammation was seen to exist at the lower part of the pharynx and the epiglottis, but both larynx and trachea were normal. Great pain was felt in attempting to swallow a little water. On the fourth day improvement set in, and at the end of a week from the commencement of his illness he was practically well. The treatment consisted in subcutaneous injections of morphia. (Morell Mackenzie, vol. ii. p. 34.)

**Œsophagitis of children.**—The form of œsophagitis here referred to occurs in children usually under two years of age, and most frequently within the earlier months of infantile life. The disease appears to have first attracted the attention of Billard, who in his work 'On Diseases of Infants' devotes considerable space to the discussion of the subject. Mackenzie also has a couple of pages dealing with the disease; and Brush, of New York, has contributed a paper seeking to attract further notice to this otherwise but little recognised affection.<sup>1</sup>

The cause of the complaint, so far as ascertained, appears to be bad feeding. Infants have been fed on artificial food, such as 'sweetened gum-water and milk and water' given too hot, or the mother or nurse has sore nipples or a defective quality of milk.

**Symptoms.**—Brush gives as the first and foremost symptom, 'an antipathy to food, and when food is taken lachrymation takes place.' Upon this latter symptom he lays great stress, deeming it almost pathognomonic. Further, any

<sup>1</sup> *New York Medical Record*, 1883, vol. xxiii. p. 35.

attempt to swallow being accompanied with pain, the child cries and ceases to suck ; and any food which may have been swallowed is promptly thrown up, frequently before it has had time to reach the stomach. Pressure on the œsophagus through the neck may cause pain. The child frequently suffers from diarrhœa, and is in all general respects very ill. Sometimes collapse becomes a prominent feature, at other times convulsions.

**Diagnosis.**—The condition is not one always easy of diagnosis. The rapid vomiting after deglutition may suggest some congenital malformation of the canal, or some cerebral mischief ; and the diarrhœa, which is a frequent accompaniment, may indicate gastro-intestinal disturbance. In vomiting, however, the result of malformation, ‘all the milk is ejected, and paroxysms of suffocation are brought on by attempts to swallow’ (Mackenzie). Again, in vomiting due to gastric disturbances the act is usually accompanied with nausea, and in vomiting due to cerebral irritation the food is not so powerfully ejected (Bruce).

**Prognosis**—Judging from the cases reported by Billard and Bruce, the disease appears a very fatal one, causing death either by inanition, or more directly through the disease itself. Cases of Condie quoted by Bruce, however, present a more favourable aspect of the disease, as all the former’s cases recovered. In one of Bruce’s cases perforation of the œsophagus took place, and in one of Billard’s gangrene of the canal.

**Treatment.**—No endeavour should be made to force the child to take fluid by the mouth. The treatment of Condie’s, which seems to have been fraught with uniform success, was to give injections *per rectum* of milk and broth. This should be done every three hours. The child’s neck should be wrapped round with warm fomentations. Before attempting to resume administration by the mouth, attention should be directed to the mother’s nipples, or if the child has been artificially fed, to the food and the mechanical means used for its administration.

CASE XXVIII.—*Œsophagitis in a child.*

H. T., aged 6 years, when first seen on July 11, presented the following symptoms: general pallor, slight distension of the abdomen.

with feeble but unmistakable cry; vomiting its food. On the 15th the face had become livid. The child refused to drink, or drank but little; cried when any forcible endeavour was made to feed it. It vomited without any effort and almost immediately after swallowing any milk; diarrhœa, which existed at the first, continued. From the 15th to 17th the symptoms continued; the pallor increased, and emaciation became marked. On the 18th the face appeared shrivelled-looking, the forehead was furrowed with wrinkles, the cry very feeble, the skin cold, and the pulse almost imperceptible. In the night the child died. Post mortem: the œsophagus was acutely injected in its upper third, the epithelium being also totally destroyed. The lower two-thirds presented several reddish striations. The stomach and intestines presented the appearance of chronic gastro-enteritis. (Billard, 'Traité des Enfants,' p. 292.)

Although this case is quoted as an example of the disease, and given as such by Billard, it must be confessed that the extensive involvement of the stomach and intestines would in all probability explain many of the symptoms. Had indeed the œsophagus not been examined at the post mortem, it is not improbable that what was found elsewhere would have been accepted as sufficient to have accounted for the symptoms during life and the death of the child.

**Membranous or pellicular œsophagitis.**—The formation of a membrane within the œsophagus may be due to diphtheria, the swallowing of boiling water, or other more obscure causes. In the case of diphtheria the membrane is usually an extension from the pharynx, the disease is of a severe and extensive type, and any œsophageal symptoms are usually masked by those arising from the involvement of other parts. As a rule the existence of a diphtheritic membrane in the œsophagus may be said to be a purely post-mortem revelation. Few, if any, authenticated cases are on record of recovery. A case recently published by Fry of Washington is a good illustration of the disease and its course.

#### CASE XXIX.—*Diphtheritic œsophagitis.*

Miss F., aged 18, when first seen was sitting up in bed spitting blood freely. On examination, the right tonsil was found to be the source of the bleeding, and upon this and the opposite tonsil were patches of diphtheritic membrane. For some three or four days the patches on the tonsils, though removed in order to give relief, always re-formed. Her pulse ranged from 120 to 140, and her temperatures from 104° to 105°. She suffered both from repeated attacks of epistaxis and hæmorrhage from the tonsil. Her breath was extremely offensive. Her menstrual



flow, which had now lasted for twelve days, had changed to a sero-sanguineous discharge and contained pieces of diphtheritic membrane. On the fifth day her restlessness reached a climax when, by combined retching and hawking, she spat up a long cast of membrane. The following day a similar cast a little less than nine inches in length was again ejected, after a fit of choking. From this period she gradually sank, and died of exhaustion. (H. D. Fry, 'American Journal of the Medical Sciences,' 1885, N.S. vol. xc. p. 329.)

The paper by Fry from which the above case is abstracted will be found to contain about all that is known of this disease. It should be consulted for further information.

With regard to membranes or pellicles which form in the œsophagus as the result of drinking boiling water, Wilks and Moxon<sup>1</sup> mention having seen two such cases. It would appear that cases arising from this cause are of little more than pathological interest, for death usually results from the injury simultaneously inflicted upon the fauces and larynx.

An interesting case has been reported by von Reichman<sup>2</sup> of a man aged 33 who for more than ten years had suffered from difficulty in swallowing. When attempting to swallow a piece of meat it suddenly became impacted. On expulsion, a mass of membrane about one hundred cubic centimeters in bulk was ejected. Difficulty in deglutition still persisted, but the passage of a bougie easily overcame the obstruction. A few days later some membrane was passed with the fæces, and other portions were vomited. The membrane was found to be 'composed of multiple layers of squamous and strongly cornified epithelium.' A somewhat similar case is quoted by Fry in the paper above alluded to. The case is recorded by Mathias Jacobæus. 'A man had difficulty in swallowing for two years and a half. He could get no relief until he passed by stool a false membrane that came from the œsophagus.' Pietkiewicz,<sup>3</sup> of Baku, reports a case of a cast being ejected from the œsophagus eleven days after swallowing a teaspoonful of a twenty-five per cent. solution of caustic soda. Severe pain was felt about the throat and breast, and increasing difficulty in deglutition. The throat was painted with glycerine solution of tannin with cocaine.

<sup>1</sup> *Pathological Anatomy*, 2nd edit. p. 365.

<sup>2</sup> Solis-Cohen, *Annual of the Universal Medical Sciences*, 1891, vol. iv.

<sup>3</sup> *Brit. Med. Journ. Epitome*, 1894, vol. ii. p. 33.

After a second painting he coughed up a 'bowel,' when deglutition became quite easy. The 'bowel' proved to be the mucous membrane of the œsophagus, detached as a whole in the form of a cylinder twenty-two centimeters long, from two and a half to three and a half broad, and from one to two millimeters in thickness. The case is described as one of 'œsophagitis gangrenosa.'

**Aphthous œsophagitis.**—As an affection of itself thrush of the œsophagus rarely, if ever, occurs. When the gullet is attacked it is almost always in association with a similar condition of the mouth or pharynx, more frequently the combination is with the mouth and the œsophagus. The diagnosis of involvement of the gullet depends almost entirely upon the difficulty of swallowing, occasionally accompanied with vomiting. The disease usually attacks infants, and but rarely leads to a fatal issue. A somewhat unique case is recorded by Langenhaus,<sup>1</sup> where the aphthæ in the œsophagus had led to a purulent inflammation of the mucous membrane. Except that the patient stated a few days before death that he had lost the power of tasting his food properly, no symptoms existed indicative of this part of his trouble. The condition was revealed post mortem.

**Chronic œsophagitis.**—Although a rare affection, chronic inflammation of the œsophagus is occasionally met with. It is usually the result of some prolonged irritation of the lining membrane of the canal, either from continuous and frequent indulgence in ardent spirits or a similar habit of taking foods too hot or too irritant. It is said also to follow upon some traumatic abrasion of the wall, and as a sequel to acute œsophagitis. A certain degree of inflammation is co-existent with syphilitic ulceration and carcinoma, and is the result not unfrequently of some organic obstruction. It is, however, as an unassociated disease that it is dealt with here.

**Symptoms.**—The inflammation being slow in its progress, the symptoms are insidious, and at first somewhat obscure. Later, however, dysphagia manifests itself, accompanied frequently with pain, at an early stage, only when swallowing solids, but later when taking fluids. As in the acute form of the disease, there is an increase in the expectoration of frothy

<sup>1</sup> Virchow's *Archiv*, 1887, Bd. cix. p. 352.

mucus, only to a much less extent. In any attempt at deglutition, auscultation of the œsophagus may reveal a delayed progress of the bolus downwards, accompanied with 'a loud harsh noise if the surface of the mucous membrane be roughened' (Mackenzie). The existence of the dysphagia may lead the surgeon to pass a bougie, when it will be found to be obstructed in its course. Such instrumentation, however, should be avoided if possible, especially where the symptoms are sufficiently clear to indicate the true nature of the affection. The passage of a bougie only tends to further irritate the mucous membrane, give pain, and often cause some bleeding.

**Diagnosis.**—The disease may be mistaken for spasm of the œsophagus; for some laryngeal disease; or for commencing carcinoma. In the case of spasm of the œsophagus the affection is transitory, the difficulty of deglutition being both sudden in its onset and in its disappearance. From laryngeal disease about the orifice of the larynx giving rise to dysphagia, the laryngoscope will show the absence of any inflammatory mischief in these parts. While from carcinoma the age of the patient may lend some assistance; but the subsequent course of malignant disease will soon exclude any possible mistake.

**Prognosis.**—With proper treatment these cases rapidly improve and get well; but recurrence is frequent.

**Treatment.**—The cause being some irritant, the treatment consists, in the first place, in removing such source of irritation, and keeping the part as much as possible at rest. This is best accomplished by a careful regimen, by which everything of an irritant nature is forbidden, while simple bland foods are alone permitted. Internal administrations are of little good. If pain exists it may be relieved by the application of a blister, a mustard poultice, or a hot fomentation. Hypodermic injections of morphia may also be resorted to.

CASE XXX.—*Chronic œsophagitis.*

C. S., a butcher, aged 47, when first seen was suffering from dysphagia and pain over the episternal notch. He had been a drinker, and had noticed latterly a slightly increased flow of saliva. Auscultation of the œsophagus revealed great slowness of deglutition. A bougie was passed, but would not descend beyond the upper third. It caused him pain and some bleeding. He was ordered milk and beef tea. A week later he was beginning to improve, and in a few days more the pain in his neck had decreased, and he was able to take some bread and milk. At the end of

two and a half months he had quite recovered. He had been advised to give up alcohol, and also to discontinue his custom of crying out the price of his goods to attract his customers. About two years after he had a second attack, but this was much milder, and passed off in three weeks. (Morell Mackenzie, vol. ii. p. 50.)

**Phlegmonous œsophagitis** and **Submucous œsophageal abscesses**.—Under the heading of Phlegmon of the Œsophagus, Puech<sup>1</sup> reports the case of a man who swallowed a tablespoonful of a solution of caustic potash and soda. At the end of eight days he vomited a long tubular cast in two portions, one measuring twenty-four centimeters in length, and the other, triangular in shape from the mucous membrane of the stomach, measuring twenty-two millimeters. The man died, but no autopsy was made. The author believes that a veritable phlegmon was produced. It may be a question whether, as a matter of classification, this case should not occur as illustrative of what has been described as membranous œsophagitis. In many, if not in all respects, it resembles the cases included under that heading.

The conditions in this class of œsophageal inflammation are, however, of little clinical significance, and have an interest more for the pathologist than the surgeon. I merely mention them to complete the list of the various inflammatory affections to which the œsophagus is subject. To this end must also be mentioned **Catarrhal** and **Follicular œsophagitis**, both affections which have been described as attacking solely the mucous membrane. **Croupous œsophagitis** consists in an infiltration of the submucous and muscular coats with pus, while the mucous membrane remains intact. A case of this nature is recorded by Dionisi.<sup>2</sup>

---

## CHAPTER V

### ULCER. VARICOSE VEINS. SYPHILIS. TUBERCULOSIS

**Ulcer**.—Several cases of simple ulcer of the œsophagus have now been recorded, and no doubt can longer be entertained of the occasional occurrence of an ulcer in this region similar in

<sup>1</sup> Joal, *Journal of Laryngology and Rhinology*, 1891, vol. v. p. 116.

<sup>2</sup> *Brit. Med. Journ. Epitome*, 1896, vol. ii. p. 9.

all respects to that more commonly met with in the stomach (see fig. 6). Many of our leading pathologists<sup>1</sup> record in their works unequivocal examples of this form of ulcer. Finlayson<sup>2</sup> related to the Glasgow Pathological and Clinical Society an interesting case which came under his observation, and referred to others of a like nature. Ulceration may occur in the course of the affections already described, for instance, as a sequel to the impaction of a foreign body, or in the course of some acute inflammatory affection of the canal. Stricture resulting from any cause gives rise to ulceration of that part of the gullet immediately above the obstruction. Syphilis, malignant disease, tuberculosis, and many of the acute exanthemata attacking any part of the canal may lead to ulceration. A form of ulceration arising from gastric solution and leading to rupture has been previously referred to (see page 15).

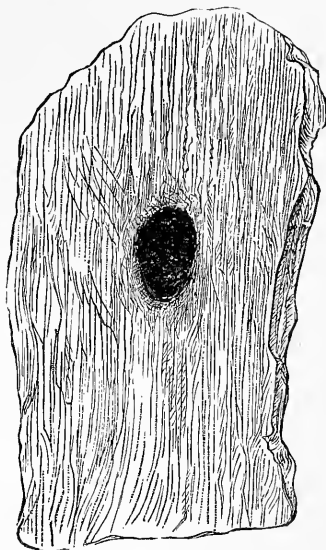

FIG. 6. — SIMPLE PERFORATING ULCER OF THE ŒSOPHAGUS. THE MAIN BRONCHUS OF THE LEFT LUNG WAS PENETRATED. (Coats)

**Symptoms.**—The occurrence of ulceration can often only be suspected, and in some cases it is not until perforation takes place that suspicion is aroused. Again, it may be said that the existence of ulceration is more frequently a post-mortem revelation than a clinical observation. Thus in a specimen exhibited by Pitt at the London Pathological Society,<sup>3</sup> ‘two similar flat oval patches of ulceration with their long diameter longitudinal, about  $\frac{3}{4}$  inch by  $\frac{1}{4}$  inch, were found in the œsophagus in process of healing.’ The child died rapidly from an acute attack of diphtheria, but had previously never shown

<sup>1</sup> See Coats, *Manual of Pathology*, 3rd edit. p. 830; also Wilks and Moxon, *Pathological Anatomy*, 2nd edit. p. 366.

<sup>2</sup> *Glasgow Med. Journ.* 1883, vol. xix. No. 4, p. 313.

<sup>3</sup> *Society's Trans.* 1888, vol. xxxix. p. 107.

any signs of ulceration of the gullet. Where there are diseases existing in which it is known that ulceration may take place, the appearance of blood in the sputum and the localisation of pain in some particular spot during deglutition may lead to a correct diagnosis. In the case of an ulcer involving the lower end of the œsophagus reported by Reher,<sup>1</sup> the symptoms were so strongly suggestive of the disease being in the stomach that it was not till the post-mortem examination was made that the real seat of the ulcer was found.

**Prognosis.**—Ulcers occurring and progressing, from whatever cause, may lead to perforation. Such perforations are more frequent in carcinoma of the œsophagus; these will be more extensively referred to under the discussion of that disease. The simple ulcer corresponding to that found in the stomach may lead to perforation. In the case recorded by Coats, the bronchus was opened into. As to the results which may accrue from the healing of an ulcer, these will depend upon the depth and superficial extent to which ulceration has taken place. Where there has been much destruction of the wall there will be a correspondingly larger formation of cicatricial tissue, and this must lead to narrowing of the calibre of the canal.

CASE XXXI.—*Simple ulcer of the œsophagus leading to stricture.*

A man aged 55 came under observation on June 29, 1885. The history of his case was that in 1869, while in the enjoyment of good health, he was seized, on the same day, with two severe attacks of hæmatemesis. This greatly enfeebled him, and he was compelled to keep his bed for a fortnight. He then got up and went about his usual work. For ten years he kept well, when in 1879 he had a fresh attack of hæmatemesis. This was succeeded in 1882 by a third return of bleeding, which lasted for four days. At this time a bougie was passed without any indication of obstruction. He again recovered completely, and then, nine months later, began for the first time to feel pain in the region of the epigastrium and posteriorly on a level with the eighth dorsal vertebra. He tried himself to pass a bougie, but found it was obstructed. Deglutition now also commenced to trouble him, and increased so as to render even the passage of fluids almost impossible. The diagnosis being made of contraction following a simple ulcer of the œsophagus, forcible dilatation with bougies was practised, with the ultimate complete relief of the patient.<sup>2</sup> (M. Debove, 'Gazette Hebdomadaire de Méd. et de Chir.' 1885, 2<sup>e</sup> série, tome xxii. p. 676.)

<sup>1</sup> *Deutsches Archiv für Klin. Med.* 1885, Bd. xxxvi. p. 454.

<sup>2</sup> The correctness of the diagnosis was verified at a post-mortem examination of the patient held two years later. See Stenosis following Simple Ulcer.

**Treatment.**—An ulcer in the œsophagus must be treated on the same broad principles which characterise the treatment of ulcers in the stomach and elsewhere. Rest alone is needed, and if for any purpose it is necessary to pass a bougie or a tube, this must be done with great care. As long as it is possible to keep up the patient's strength by nutrient enemata, nothing except a little ice, or a little bland fluid of some kind, should be given by the mouth. It is not merely the passage of substances over the surface of the ulcer which must be considered, but the disturbing effect of the muscular contraction caused by deglutition.

**Varicose veins.**—The existence of varix or phlebectasis in the œsophagus is not an infrequent occurrence. Thus Morell Mackenzie,<sup>1</sup> in the examination of eighteen gullets taken at random, found more or less dilatation in seven and distinct varix in two. Frequent, however, as would seem to be the existence of some degree of this condition, it is rarely that symptoms indicative of it arise. It has recently been shown by C. A. Blume,<sup>2</sup> of Copenhagen, who injected the œsophageal vessels, that the submucous veins empty into the coronary vein of the stomach, while the pericœsophageal veins communicate with the diaphragmatic and azygos veins. Obstruction therefore occurring in the liver, as from cirrhosis or senile atrophy, gives rise to a dilatation of the submucous veins; and these being connected with the pericœsophageal, an increased vascular connection is formed between the portal vein and the vena cava. Such increased connection between these two large veins is said to retard for a time the progress of ascites in cases of cirrhosis, but the dilatation of the veins so occasioned renders them liable to rupture, and thus to become the cause of hæmatemesis. Varices as a cause of hæmatemesis in cirrhosis of the liver has been made the subject of an exhaustive paper by J. Stacy Wilson and J. R. Ratcliffe,<sup>3</sup> who incorporate several cases illustrative of the condition.

It is possible that in some instances the varicose condition of the veins may be congenital. Such seems the only explanation

<sup>1</sup> Vol. ii. p. 54.

<sup>2</sup> Solis-Cohen, *Annual of the Universal Medical Sciences*, 1889, vol. iv. G—36.

<sup>3</sup> *Brit. Med. Journ.* 1890, vol. ii. p. 1480.

in a case recorded by Friedrich.<sup>1</sup> A child aged 6 years had for two years suffered from repeated hæmorrhage, from which it died. It was at first thought that the blood came from the stomach, but at the post mortem the œsophagus was found filled with thick varicose veins.

The position of the affected veins may be above, below, or at any intermediate place. In obstructive disease of the liver they appear more frequently at the lower end; while in old age, when varices are prone to form in various regions, they are found more at the upper part.

**Symptoms and diagnosis.**—The recorded instances of uncomplicated cases of varix are far too few to admit of any special symptoms being stated that might be termed pathognomonic of the complaint. When hæmorrhage results from varix, in which the latter condition is dependent upon some obstructive influence working on the portal circulation through the liver, it is all but impossible to say whether the blood is from the stomach or the gullet. Blume affirms that when the hæmorrhage is due to a rupture of the varicose veins, the blood is ordinarily expelled by a sort of regurgitation without vomiting. In cases of varix occurring at the middle and upper part of the œsophagus, Mackenzie asserts the possibility of establishing a diagnosis by means of the œsophagoscope, and in one of his own recorded cases he was enabled to do so. In the absence of any other symptoms suggestive of disease of the liver, the cause of the hæmorrhage might be suspected to be in the œsophagus. Here again, however, as in the case below recorded, the diagnosis would more likely be that of gastric ulcer, and it would be difficult to distinguish between the two complaints. The hæmorrhage from a ruptured vein may be sufficiently copious to cause death, as in a case reported by Viti.<sup>2</sup>

**Treatment.**—Where there is reason to suspect that blood is coming from varicose veins of the œsophagus, the treatment will be in all respects such as would be adopted in the case of gastric ulcer. Cold may be applied externally either to the sternum and epigastrium or to the back. Ice may be sucked,

<sup>1</sup> *Journal of Laryngology and Rhinology*, 1895, vol. ix. p. 284.

<sup>2</sup> *Brit. Med. Journ. Epitome*, 1890, vol. ii. p. 65.



or astringents may be administered. Zenker<sup>1</sup> advises tincture of the perchloride of iron in doses of 5 to 10 drops. Mackenzie<sup>2</sup> prescribes a mixture of tannic and gallic acids. Nutrient enemata should take the place of food by the mouth so long as the tendency to hæmorrhage exists; but when bleeding seems to have ceased, iced milk may be given, and a milk diet maintained for some time.

CASE XXXII.—*Variæ of the œsophagus. Death from hæmorrhage.*

A man aged 40 had been ill for twelve years. He dated his illness from an attack of typhoid fever which occurred at the beginning of that time. He was in bed for seventeen weeks, and his life at one time despaired of. He had adopted several means to recoup his strength. Four years ago he first vomited blood, and during the last year he had eight times brought up blood. He was subject to bilious attacks, as appears were also his mother, brothers and sisters. Sometimes he suffered from heartburn, and sometimes felt sharp pains in the region of the stomach. His bowels were constipated, and occasionally the stools contained blood. He suffered from hæmorrhoids. On May 12, from no error in diet, he vomited some dark red coagulated blood. There was tenderness in the pit of his stomach; and succussion of the patient gave rise to evident fluctuation in the region of the stomach. His tongue was fissured, moderately pale, and yellowish posteriorly. All his other organs appeared healthy. Ulcer of the stomach was diagnosed. Vomiting of blood continued on May 18 and 19, when the patient died. At the post mortem extensive varicosity of the veins was found at the lower part of the œsophagus, with a well-marked rent in one of the veins; with the exception of a fatty heart, there was no evidence of disease elsewhere. (Eberth, 'Deutsches Archiv für Klin. Med.' 1880, vol. xxvii. p. 566.)

CASE XXXIII.—*Fatal hæmorrhage from varicose œsophageal veins.*

The patient was a man aged 60, who had had syphilis when about 25, and had drunk to excess since about his twentieth year. In 1890 he suddenly vomited about two pints of blood. He was repeatedly tapped for extreme ascites. He suddenly brought up several pints of pure blood and passed some with the stools, and died on the following day, apparently from exhaustion. The liver was found to be contracted and much altered in shape. The veins in the lower part of the œsophagus were greatly enlarged, and there was a distinct opening in one, leaving no doubt as to the source of the hæmorrhage. The stomach appeared to be normal. (Eddison, 'Brit. Med. Journ.' 1893, vol. i. p. 239.) See also another case reported by Letuille and abstracted by Joal, in 'Journal of Laryngology and Rhinology,' 1891, vol. v. p. 116.

---

<sup>1</sup> *Cyclopædia of the Practice of Medicine*, vol. viii. p. 133.

<sup>2</sup> Vol. ii. p. 55.

**Syphilis.**—The lining membrane of the œsophagus, like the skin and mucous membrane elsewhere, is liable to be attacked by some form of syphilitic inflammation. This is, however, a rare complication of both the hereditary and acquired forms of the disease. Pathologically considered, the lesion is mostly some form of ulceration, either superficial where the mucous membrane is first involved, or deep where the primary source has been a gumma. The result in both cases is the same; healing usually takes place, and the cicatrix formed may or may not give rise to stricture of the canal according to the depth and extent of the original lesion. Syphilis is sometimes the cause of œsophageal paralysis; but in such cases the lesion is primarily connected with the nervous system, and the gullet thus secondarily involved.

**Symptoms.**—The chief symptom is that of dysphagia, comparatively slight at first, but gradually increasing as the canal becomes narrowed. During the active stages of ulceration some slight hæmorrhage may exist and localised pain be complained of. The various symptoms arising from stricture due to this disease will be more fully discussed in the chapter dealing with cicatricial stenosis.

**Diagnosis.**—There will be little difficulty in deciding that the symptoms of obstruction are due to some organic lesion, but it will not be so easy to determine whether or not the existing cause is syphilis. There is nothing special in the symptoms to distinguish them from those dependent upon ulceration or stricture due to other causes, and the diagnosis—almost always conjectural—must be based on the existence or pre-existence of syphilitic manifestations elsewhere.

**Treatment.**—The usual specific remedies will be called for, especially iodide of potassium; for the disease, when it comes under treatment, is usually in its later or tertiary stage than in the earlier. In addition nourishment must be administered on the principle of giving rest to the part, and on the general lines before laid down in all cases of ulceration. The treatment of stricture will be dealt with later.

**Tuberculosis.**—There is little to be said about this disease. As a primary affection there appear to be no really authenticated recorded instances. The œsophagus is sometimes secondarily involved in tubercular processes taking place

elsewhere. Many references to such cases are given by Mackenzie,<sup>1</sup> but the larger proportion of these are doubtful. Zenker and Ziemssen<sup>2</sup> mention having seen two cases which they thought might possibly be illustrations of the affection. Several other cases also are referred to in a paper by Weichselbaum,<sup>3</sup> who bases his remarks upon a case which came under his observation. Zemmann<sup>4</sup> has met with some cases, and instances four ways in which the œsophagus may be implicated. The most frequent method of involvement is by extension from a tuberculous gland, which gradually eats its way into the œsophagus and so infects it. Another mode of invasion is directly from the larynx. A third source of infection arises from inoculation of a part of the canal—previously injured by swallowing some caustic fluid—by swallowing tubercular sputum in cases of pulmonary phthisis. A fourth kind of involvement is where the disease of the œsophagus is a part of a general miliary tuberculosis; and he quotes, in illustration of this last, Mazotti's case of a boy aged 10 who had also acute tubercular meningitis. Flexner<sup>5</sup> more recently has reported a case somewhat similar to Mazotti's, inasmuch as the tubercular ulcers found in the œsophagus were part of a general tuberculosis. Bacilli were found in these ulcers. Konrad Zenker<sup>6</sup> records two instances of infection of the œsophagus, from primary disease in the lungs in one case, and tubercular mediastinal glands in the other. In both the gullet was perforated. Weichselbaum's case appears to be an unequivocal illustration of the disease. Not only were the lesions strongly suggestive of tuberculosis to the naked eye, but, as in Flexner's case, the existence of the tubercle bacillus was demonstrated. During life the patient presented no symptoms indicative of involvement of the œsophagus. She had tuberculous caseating glands in the neck, which had been opened. Her death subsequently took place from pulmonary phthisis, although she had no symptoms of this disease when first seen. At the post mortem the œsophageal mischief was discovered, and

<sup>1</sup> Vol. ii. p. 112.

<sup>2</sup> *Cyclopædia of Medicine*, vol. viii. p. 191.

<sup>3</sup> *Wiener Medizinische Wochenschrift*, 1884, vol. xxxiv. p. 151.

<sup>4</sup> *Ibid.* 1886, No. 49, p. 1646.

<sup>5</sup> *Brit. Med. Journ. Epitome*, 1893, vol. i. p. 60.

<sup>6</sup> *Deutsches Archiv für Klin. Med.* 1895, Bd. lv. p. 422.

around the organ in its thoracic part numerous caseating and suppurating glands existed. Weichselbaum expresses his belief that the infection of the œsophagus was due to a perforation of the canal by a tuberculous gland.

The disease cannot be said to have any special surgical interest, and indeed its existence as yet has been little else than a pathological curiosity. Why the œsophagus should be so exempt from infection it is not easy to say, unless it be, as suggested by Weichselbaum, that the virus, which may attack other parts of the alimentary canal, passes too rapidly down the œsophagus to seize upon its walls.

---

## CHAPTER VI

TUMOURS : INNOCENT—PAPILLOMA. CYSTS. FIBROMA. ADENOMA.  
MYXOMA. MYOMA. LIPOMA

VARIOUS kinds of benign tumours, as pathologically understood, have from time to time been found attached to the inner wall of the œsophagus. Occurring, however, in whatever form, they are but rarely met with, and still more rarely diagnosed. Although innocent structurally, they have in some cases, from the special nature of the region attacked, given rise to severe symptoms, ending fatally. It would seem, however, that in not a few cases there are no symptoms at all, and quite accidentally tumours have been discovered after death. As in malignant tumours, these benign growths are found more frequently in men than in women, and for this reason it has been assumed that irritation, caused mostly through the consumption of alcohol, is the exciting cause of some topical development.

The benign growths which have been found in the œsophagus are warts or papillomata, cysts, fibromata, adenomata, myxomata, and myomata. Some authors add also lipomata ; but while instances are recorded illustrative of each of the former growths, there appears no authentic reference to a case of the latter.

**Warts or Papillomata.**—These growths appear to be hypertrophied papillæ of the mucous membrane, covered with

additional layers of epithelium. They may be said to resemble warts on the skin, and, like them, may be simple or multiple. They may exist in any part of the canal, and are sometimes sprinkled over its entire length. They are found usually in elderly people, and are unaccompanied by any special symptoms. A typical example of these tumours was shown by Sharkey<sup>1</sup> to the Pathological Society of London. It was taken from a man aged 67 years who died of chronic bronchitis. The mucous membrane of the œsophagus was thickly studded with tumours, varying in size from a pin's head to a pea.

**Cysts.**—In most cases these are simple retention cysts arising in connection with the mucous follicles. When of such a nature they are not usually large, rarely exceeding in size a pea, and do not number more than one or two. They contain viscid mucus. Instances of much larger cysts than these have been recorded. Fagge<sup>2</sup> showed a specimen, at the Pathological Society of London, of a cyst as large as a pigeon's egg. It was filled with viscid mucus, and projected considerably into the œsophagus. Whether the patient had suffered from dysphagia was not ascertained. Wyss<sup>3</sup> records an example of a still larger cyst. It was about the size of an apple, and, as far as was known, had not given rise to trouble during life.

**Fibromata, Adenomata, Myxomata, and Myomata.**—These growths constitute relatively the most frequently met with forms of benign tumours. They usually occur as polypi attached by a distinct neck or constricted base to any part of the wall of the gullet, although the region of the cricoid cartilage is perhaps the most usual spot. In size they vary considerably, being as a rule much greater in length than breadth. When attached by an elongated pedicle they may occasionally present at the back of the throat, or even project into the mouth. In a case reported by Annandale<sup>4</sup> the polypus measured four inches in length, an inch and a half in breadth, with a pedicle about the size of a lead pencil and

<sup>1</sup> The Society's *Transactions*, 1885, vol. xxxvi. p. 189.

<sup>2</sup> *Ibid.* 1875, vol. xxvi. p. 96.

<sup>3</sup> Virchow's *Archiv*, 1870, Bd. li. p. 144.

<sup>4</sup> *Brit. Med. Journ.* 1878, vol. ii. p. 761.

two inches long. In any fit of retching or coughing the polypus came out of the patient's throat on to his tongue. In another case, reported by James,<sup>1</sup> a polypus about the size of a pea and pear-shaped used to appear in the patient's mouth just behind the tongue. On attempting to extract it, it burst, and a little glairy fluid escaped. A case of ordinary mucous polypus is recorded by Cheatham.<sup>2</sup> It was five inches in length and one inch in diameter, and in vomiting was projected into the mouth. Ziemssen<sup>3</sup> quotes a case of Rokitansky's which appears to be one of the largest specimens of fibrous polypus recorded. It measured seven and a half inches in length and, at its blunt end, which was situated two and a half inches above the cardia, two and a half inches in thickness.

As illustrations of myomata are the cases repeatedly quoted of Coats<sup>4</sup> and Hilton Fagge.<sup>5</sup> In the case reported by the former, a lobulated tumour measuring four and three-quarter inches from above downward, two inches in a transverse diameter and about an inch and a quarter in the other diameter, was found extending from a point about six and three-quarter inches below the level of the glottis downwards to the cardiac orifice of the stomach. The tumour was removed post mortem from a man aged 61 years. In Fagge's case the tumour grew from the anterior wall of the gullet, just below the bifurcation of the trachea. It was egg-shaped, and its long axis, which lay obliquely, measured two inches, its other axes being respectively one inch and a quarter and one inch.

**Symptoms.**—With so few cases to deal with, and with such inconstancy in the symptoms presented, it is not possible to indicate any features which may be said to be generally characteristic of polypus of the gullet. Dysphagia, which would naturally be the most likely symptom to exist, is often absent, and that too in some of the most marked cases. Thus in Annandale's case the patient never suffered either from

<sup>1</sup> *Brit. Med. Journ.* 1878, vol. ii. p. 832.

<sup>2</sup> Solis-Cohen, *Annual of the Universal Medical Sciences*, 1892, vol. iv. p. 30.

<sup>3</sup> *Cyclopaedia*, vol. viii. p. 171.

<sup>4</sup> *Glasgow Med. Journ.* 1871-72, N.S. vol. iv. p. 201.

<sup>5</sup> *Trans. Path. Soc. Lond.* 1875, vol. xxvi. p. 94.

trouble in swallowing or difficulty in breathing. Likewise in Fagge's case there was no dysphagia, and in that of Coats's dysphagia appeared only ten weeks before death. In Rokitsansky's case, where the polypus was the largest on record, dysphagia was only suffered from a few months before the patient's decease, and then only lasted for a short time. On the other hand, where the polypus was no larger than a pea, as in James's case, the woman suffered from dysphagia for a year, and when first seen she could hardly swallow anything. In the first of Mackenzie's three recorded cases<sup>1</sup> the polypus was about the size of a marble, and difficulty in swallowing had been experienced for eleven months. The dysphagia increased until only liquid nourishment could be taken. In other cases, again, there have been prolonged symptoms of difficulty in swallowing, with periods of intermission, when food could be taken with moderate ease; the existence of such intermittency might reasonably suggest the presence of some benign obstructing growth. In the third of Mackenzie's cases symptoms of dysphagia had existed more or less for six or seven years. When the polypus moves freely by a long pedicle, it may, by coughing or retching, be brought up to the back of the throat or into the mouth, as instanced in the cases above.

CASE XXXIV.—*Polypus of the œsophagus.*

A man aged 47 years consulted Sir Morell Mackenzie in June 1875 on account of difficulty in swallowing. This symptom was first noticed two and a half years previously after eating some fish, and the patient attributed the trouble to the lodgment of a bone. The difficulty in swallowing had increased by slow but not regular degrees. At first it was slight and only came on occasionally, whilst at other times the food went down perfectly well. During the first six months of 1874 the dysphagia passed off, but in the beginning of July of that year it suddenly returned. At the patient's urgent solicitation a parasol bougie was passed. It went down easily, but in withdrawing it some difficulty was experienced, when suddenly the obstruction yielded, and a small pedunculated tumour about the size of a bantam's egg fell from the patient's mouth. He subsequently brought up about a teacupful of blood. With only this symptom and a little pain in swallowing for a few days, he ultimately quite recovered. (Morell Mackenzie, 'Diseases of the Throat and Nose,' vol. ii. p. 104, case 2.)

**Treatment.**—The removal of the polypus is the only object aimed at, and this has been effected in some cases

<sup>1</sup> *Diseases of the Throat and Nose*, vol. ii. p. 104.

accidentally, and in others by similar simple methods to those used in the case of nasal polypi. In two of Mackenzie's cases the polypus was removed accidentally during the process of examination of the patient by the passage of a parasol bougie: on withdrawing the bougie a hitch was felt, which suddenly gave way, and the tumour was brought up. In Annandale's case the tumour was caught by forceps and its base encircled with an écraseur. Stephan rather ingeniously induced vomiting by the hypodermic injection of a sixth of a grain of apomorpha, which caused the tumour to be thrown into the mouth, when it was caught with a vulsellum forceps, surrounded with a wire snare and cut off close to its base. In whatever way removed, a little hæmorrhage usually follows the detachment of the growth, but this soon subsides, and after a few days of painful deglutition, variable in degree, the patient makes a complete recovery.

---

## CHAPTER VII

### TUMOURS: MALIGNANT—CARCINOMA AND SARCOMA

**Carcinoma.—Etiology.**—The œsophagus, like other portions of the alimentary canal, is liable to be attacked by carcinoma. Anatomically it is made of the same tissues, in which the disease is prone to arise; and physiologically it is subject to the same exciting causes. Whatever part irritation may take in initiating the malignant process, it can hardly be deemed so cogent a factor in the appearance of the disease as might be, and is usually, supposed. The comparative rarity of carcinoma of the œsophagus, and the universal frequency with which that canal must be accidentally irritated by the occasional deglutition of hot fluids, excess of stimulants, insufficiently masticated food, &c., renders it more than likely that some other factor, more potent than that of irritation, must be looked for in many cases. Whether that factor is to be found in a simple predisposition of the tissues—and this supposition is strongly supported by the greater frequency of the disease in members of a family where it has already shown itself in some form—or in some phase connected with the new development of the parasitic theory must remain for future



decision. The subject, however, is one touching the general pathology of carcinoma; while here we have to deal with this disease as a local affection, attacking a particular region. However the affection may arise, it is usual, with our present knowledge, to ascribe it to a predisposition of the tissues, incited to undergo these special changes by some mechanical injury to the particular part.

Statistics leave little doubt that the disease is far more frequent in men than in women; thus in 100 cases collected by Morell Mackenzie<sup>1</sup> the disease was found 71 times in men and 29 in women. The age at which it most frequently appears is from 50 to 60 years. The decades immediately before and after this show an equal frequency, and in both cases but slightly numerically less. Before 20 years and after 80 years the œsophagus is rarely affected.

**Pathology.**—No portion of the œsophagus is exempt from invasion. From its commencement to its termination carcinoma has attacked any region, and any part of that region. Various portions of the tract have been signalled out as more frequently involved than others, but the want of uniformity in the results obtained by different statisticians renders it almost impossible to indicate one part more than another as being specially prone to the disease. Butlin<sup>2</sup> is probably right in giving the central portion of the canal as that least often affected.

From the nature of the circumstances, as regards the seat of the disease, and its insidious onset, it is not possible to know what are the first pathological manifestations of the growth. It can only be assumed that its origin will be much the same as where carcinoma arises on some visible surface. Thus it may commence as a small papilloma or warty growth, as a surface plaque or a deeper-seated induration, as a fissure, abrasion, or slight ulceration; but in whatever way the disease first manifests itself, sooner or later growth and ulceration become the prominent pathological processes, and we finally have all those later appearances with which we are familiar in the post-mortem room.

It must be remembered that in dealing with carcinoma,

<sup>1</sup> *Diseases of the Throat and Nose*, vol. ii. p. 75.

<sup>2</sup> *Operative Surgery of Malignant Disease*, p. 207.

wherever it is found, three pathological processes are at work : growth, destruction, and contraction. The growth as seen in the region under discussion manifests itself at the advancing part of the disease -- that is to say, it forms prominent edges to the ulcerating surface, and indurates the neighbouring tissues by infiltration. Destruction is seen towards the central part of the disease, where the process may either be molecular disintegration or the separation of large sloughs. This process in its progress rapidly leads to the destruction of parts beyond that of the region attacked. Thus the œsophagus is perforated and any neighbouring cavity or structure opened into. The process of contraction consists in the development of fibrous tissue both within and without the tumour tissue proper. The shrinking of the fibrous stroma of the growth, as also of that developed as the result of inflammatory irritation, gives rise to the narrowing of the canal ; and this, together with the projecting masses of the growth, cause all those symptoms of obstruction which form the striking features and characteristics of the disease.

The macroscopical appearances of the diseased part when seen on the post-mortem table are extremely various. A typical example will be that of a mass of growth completely encircling the canal for a variable extent upwards and downwards, and reducing its calibre to a minimum. Ulceration will also be found to a greater or less extent. While then it may be said to be the rule to find a limited circumferential contraction and ulceration, numerous cases occur where the disease is both more limited and more extensive. Thus the disease may extensively invade the wall of the canal and yet not diminish its calibre, as in a case recorded by Hoden ;<sup>1</sup> somewhat similar cases are also recorded by Newman<sup>2</sup> and by Page.<sup>3</sup> The growth may form a mere localised projection into the canal ; at other times specimens are met with where more than one spot seems to be separately affected. In many of these there is direct lymphatic connection, the disease travelling along the lymphatic channels and then developing as apparently isolated centres. Page's case<sup>3</sup> apparently

<sup>1</sup> *New York Medical Record*, 1888, vol. xxxiii. p. 719.

<sup>2</sup> *New York Med. Journ.* 1879, vol. xxx. p. 158.

<sup>3</sup> *Medical Press and Circular*, 1892, vol. i. p. 413.

PLATE III.



Fig. 7.—CARCINOMA OF ŒSOPHAGUS.—A flat fungating tumour occupies about the lower  $4\frac{1}{2}$  inches of the gullet. The mass ends abruptly above, but below presses down against the wall of the stomach, but the latter is not involved. The ring of whalebone, seen below, indicates the cardiac orifice; and the piece above a small perforation which lead to gangrene of the lung. (*H.J.M., Glas.*)



illustrates this method of extension. The chief seat of the disease was opposite the bifurcation of the trachea; at the cardiac extremity of the stomach was a similar growth. Between the growths the mucous membrane on the summit of the rugæ contained numerous areas of carcinoma which varied in size from a mere point to a small bean, and were mostly linear in shape and direction. In some cases the disease extends from the œsophagus directly by continuity into the stomach, as in a case recorded by Burnet,<sup>1</sup> the cardiac end and the lesser curvature being involved; or the stomach may be infected, with no obvious connection between the two centres of disease. Thus in a case recorded by Hadden<sup>2</sup> a small nodule of growth was found in the mucous membrane of the stomach just beyond the cardiac orifice, the main centre of the disease being located in the upper part of the œsophagus. Specimens from a similar case were shown to the Montreal Medico-Chirurgical Society by Wyatt.<sup>3</sup> At the autopsy two epitheliomata were found high up in the œsophagus; whilst within the stomach, near the œsophageal opening, was another tumour. How extensive may be the invasion of the disease is well illustrated by a case recorded by Finny.<sup>4</sup> The region affected commenced opposite the arch of the aorta, and from that spot to within a quarter of an inch of the stomach the canal was one mass of disease of a most extensive nature. A more severe case<sup>5</sup> than this even is illustrated by a specimen in Guy's Hospital Museum 'where nearly the whole length of the tube is occupied by the disease in its sloughing stage.' Besides the various appearances presented by the seat of the disease itself, the œsophagus both above and below, especially above, undergoes changes, as the result mostly of the obstruction in its canal. Thus above the seat of disease the walls of the gullet may become thickened from muscular hypertrophy, and the whole calibre of the canal may be dilated (see Plate V. fig. 9). In a case reported by Roosevelt,<sup>6</sup> where the disease was situated near the cardiac

<sup>1</sup> *Trans. Path. Soc. Lond.* 1881, vol. xxxiii. p. 191.

<sup>2</sup> *Brit. Med. Journ.* 1891, vol. ii. p. 1097.

<sup>3</sup> *Journal of Laryngology and Rhinology*, 1891, vol. v. p. 327.

<sup>4</sup> *Dublin Journal of the Medical Sciences*, 1882, 3rd series, vol. lxxiv. p. 167.

<sup>5</sup> *Pathological Anatomy*, Wilks and Moxon, 2nd edit. p. 366.

<sup>6</sup> *New York Med. Journ.* 1887, vol. xlv. p. 500.

orifice and the calibre, so small that only a probe could be passed, the dilatation extended up to near the thyroid cartilage, and converted the œsophagus into a cavity about the size of a 'champagne bottle.' Such an extensive dilatation in malignant disease is uncommon—although the author expressly points out that in his case the obstruction was of a malignant nature. The complaint usually runs a too rapid course, and the food taken is too little for any very marked dilatation to take place above the obstruction.

The form of carcinoma usually met with in the œsophagus is the flat- or squamous-celled epithelioma. Ninety per cent. of the tumours met with are, according to Butlin, of this kind. Both forms of the glandular-celled carcinoma have been met with—that is, the scirrhus and medullary; an instance also of the colloid form has been recorded by Bristowe.<sup>1</sup> To these has now apparently to be added examples of the cylinder-celled variety. One case I found recorded by Parmentier,<sup>2</sup> who presents this form of epithelioma ('cylindro-prismatique') as an instance of extreme rarity. The origin of the tumour appears to have been in the œsophageal glands. Another case is mentioned by David Newman.<sup>3</sup>

In addition to the diseased centre itself in the œsophagus, extension takes place into the neighbouring and distant organs both by direct continuity and by means of the lymphatics. Thus by direct extension of the growth the lungs may be invaded, or the heart; masses of tumour may exist in the tissue surrounding the œsophagus, either in the thorax or in the neck. Secondary nodules may be found in the liver, kidneys, spleen,<sup>4</sup> small intestine, mesenteric glands, bones, and other organs and tissues. The lymphatic glands in the post-mediastinal and deep cervical regions are those most frequently involved. Occasionally, however, more distant glands are attacked. Thus Parry Price<sup>5</sup> mentions a case where the glands in both axillæ, and both posterior triangles were enlarged. Various inflammatory lesions from perforations are sometimes found. These may take the form of an

<sup>1</sup> *Trans. Path. Soc. Lond.* 1868, vol. xix. p. 228.

<sup>2</sup> *Archives Générales de Médecine*, 1889, vol. i. p. 470.

<sup>3</sup> *Lancet*, 1892, vol. i. p. 9.

<sup>4</sup> N. Moore, *Lancet*, 1883, vol. i. p. 13.

<sup>5</sup> *Brit. Med. Journ.*, 1886, vol. i. p. 68.

acute cellulitis or a localised abscess when the perforation leads into cellular tissue, or pericarditis or pleurisy if the pericardial or pleural cavities are invaded. When the bronchus or lung is opened into, pneumonia and gangrene are the usual sequels. More uncommon results are occasionally met with. Thus in a case recorded by Klein,<sup>1</sup> gangrene of the left auricle and of the spleen was found at the post mortem; emboli existed both in the coronary and splenic arteries. Desmos<sup>2</sup> draws attention to three cases where death resulted from pleuro-pneumonia, and in none of these was there perforation or direct extension to account for the lung lesion.

**Symptoms.**—As a disease of itself, carcinoma occurring in any part of the human body presents one common and usually constant symptom, that of progressive emaciation; but the special symptoms which become peculiar to it as it attacks various parts of the body are connected largely with the functional and organic disturbances caused by its development in that particular part. So here, in the case of the œsophagus, the growth of the tumour within the canal tends to obstruct its calibre, and hence from that obstruction arises some of the most prominent and characteristic features of the disease.

Although not the usual way of describing the symptoms of the disease, and taken exception to by some, it has seemed to me likely to simplify the discussion by dividing them into local and general.

*Local symptoms.*—These symptoms are connected entirely with the tumour within the canal, and are among the earliest to manifest themselves. Dysphagia is frequently the first symptom which indicates the onset of the disease. The patient's attention is attracted by the difficulty in swallowing certain foods, mostly of a dry, solid consistency. This difficulty slowly increases until it is found that unless the solid food is very thoroughly masticated or freely moistened with fluids it will not pass into the stomach. It descends a certain distance, remains for a few minutes, and is then gulped up. At a later stage solids under any form will not pass, and the patient finds himself forced to limit his nourishment entirely to fluids. Still later, difficulty is experienced in swallowing fluids, and in

<sup>1</sup> *Archiv für Path. Anat.* 1889, Bd. cxviii. p. 69.

<sup>2</sup> *Revue Mens. de Méd. et de Chir.* 1879, p. 49.

the latest stage little or nothing can be got to pass the obstruction. It not unfrequently happens that when the obstruction is at its worst a sudden and marked improvement takes place. This, however, is only temporary, and is due to the accidental removal of a portion of the growth, which renders for a time the canal more permeable.

A sense of obstruction is often experienced by the patient. He feels the place at which the food lodges, and is often conscious—to the extent sometimes of suffering pain—of its slow progress past the obstruction. At times a small amount of bleeding may take place from the ulcer, and the patient expectorates blood-tinged mucus. As the obstruction increases there is an inability to swallow saliva, and hence this and the mucoid secretion from the oesophageal glands cause the patient to constantly expectorate, at first a more or less frothy mucus, but later a much more viscid material.

The pain experienced is variable in degree, kind, and situation; at times it is so slight that but little more than a feeling of inconvenience is experienced; at other times its severity is marked by sharp, shooting, or burning sensations located behind the sternum, in the epigastrium, or posteriorly between the shoulder blades.

*General symptoms.*—Prominent among the general symptoms is the progressive and rapid emaciation. Whatever may be the amount of wasting due directly to the growth of the tumour itself, it is largely augmented through the increasing diminution of nourishment which reaches the stomach. This insufficiency of food causes at the earlier stage of the disease a feeling of hunger, but this soon gives place to sensations of faintness. The stomach also suffers from the want of its ordinary stimulants, and fails at last in its proper digestive function, so that not infrequently such food as does reach it remains for some time in an undigested condition. Should vomiting result from these digestive disorders, much pain and inconvenience are experienced. The breath frequently becomes very offensive, due in some cases to the gastric disturbances, and in others to ulceration and sloughing at the seat of the disease. Dryness of the tongue and fauces, with troublesome thirst, are distressing symptoms towards the close. The bowels are constipated.



Excluding complications which will be referred to later, the above local and general symptoms may be taken as examples of those most commonly met with. It will be right, however, to allude briefly to a few modifications of these which occasionally present themselves.

The onset of the disease may be quite sudden. Several cases have now been recorded where the patient while engaged in eating his ordinary meal suddenly encountered difficulty in swallowing a bolus of food. In Stanley Boyd's case<sup>1</sup> the patient from that moment onwards experienced great difficulty in deglutition. In some cases published by W. P. Thornton<sup>2</sup> and by Butlin,<sup>3</sup> the patients had enjoyed perfect health up to the period of the sudden appearance of severe obstruction.

Again, dysphagia may never be a symptom throughout the disease; thus in G. E. Paget's case<sup>4</sup> pain was the most prominent symptom. The patient never complained of any difficulty in swallowing, and died from ulceration extending into the aorta. In a case reported by Stockwell<sup>5</sup> the first symptom of dysphagia was concomitant with that of perforation of the bronchus. In the case of Newman's<sup>6</sup> already referred to, the earliest symptoms were those of dyspepsia and regurgitation of food. Throughout, this patient never suffered from pain. While it is usual for food to be almost immediately ejected after being swallowed, it is sometimes delayed in its return; thus in Roosevelt's case already quoted, where the œsophagus was enormously dilated, the food swallowed did not return often for nearly two hours. In some cases so little like the ordinary symptoms met with have those which presented themselves been, that a mistaken diagnosis has been made. In a case recorded by Smith<sup>7</sup> the earliest symptoms consisted of burning pain in the stomach of considerable severity, heartburn, water-brash, and pain in the back and shoulders. The cause was diagnosed as one of cancer of the stomach, but was subsequently proved to be disease of the lower third of the œsophagus.

<sup>1</sup> *Brit. Med. Journ.* 1882, vol. i. p. 538.

<sup>2</sup> *Lancet*, 1881, vol. i. p. 617.

<sup>3</sup> *Ibid.* p. 677.

<sup>4</sup> *Brit. Med. Journ.* 1882, vol. i. p. 192.

<sup>4</sup> *Ibid.* vol. ii. p. 888.

<sup>6</sup> *New York Med. Journ.* 1879, vol. xxx. p. 158.

<sup>7</sup> *Dublin Journal of the Medical Sciences*, 1880, 3rd series, vol. lxix. p. 53.

In a case also, reported by Finlayson,<sup>1</sup> aphonia was such a prominent symptom that a diagnosis of advanced laryngeal phthisis with ulceration was first formed. The case subsequently turned out to be one of cancer of the œsophagus involving the left recurrent laryngeal nerve. In Roosevelt's case the diagnosis was chronic gastritis. In Burnet's case above quoted the first symptom noted was a sensation of tickling in the gullet. It was not until six months later that symptoms of dysphagia showed themselves.

The quantity of mucus expectorated varies within considerable limits. Sinclair<sup>2</sup> reports a case where the patient brought up every day a quantity of glairy mucus, measuring from two to fifteen ounces, in much the same way as he rejected food. This glairy substance appears to have been saliva that collected in the œsophagus.

**Secondary complications.**—In the later stages of the disease symptoms not infrequently arise which indicate complications due to some extension of the disease into neighbouring organs and tissues. Thus dyspnoea may arise from pressure upon or invasion of the trachea; a sudden violent fit of coughing arising spontaneously or on any endeavour to swallow fluid may indicate the formation of a communication between the œsophagus and the main air passages. A sudden hæmorrhage may be due to the opening of a blood vessel; and here it may be remarked that any vessel, whether vein or artery, lying in close proximity to the gullet may be laid open by ulceration. The larger the vessel, the more copious and serious will naturally be the hæmorrhage. Involvement of the recurrent laryngeal on either side, although the left is more frequently implicated, may cause some laryngeal irritation with cough, or complete paralysis of one vocal cord with some aphonia. A rise of temperature, with other concomitant symptoms of feverishness, should lead to suspicion of inflammation arising somewhere. This may be of the nature of a pleurisy, a pericarditis, or a pneumonia, in which case the symptoms distinctive of each will soon serve to establish the diagnosis. A fulness or hardness in the neck, with increasing redness and tenderness,

<sup>1</sup> *Trans. Path. and Clin. Soc. Glasgow*, 1892, vol. iii. p. 250.

<sup>2</sup> *Brit. Med. Journ.* 1885, vol. i. p. 594.

will denote cellulitis, with the possible formation of an acute abscess. When considerable pain is complained of, this may be due to secondary deposits in the bones. In the case recorded by Finlayson the severe abdominal pain from which the patient suffered turned out to be due to a cancerous tumour in the body of the twelfth dorsal vertebra.

**Diagnosis.**—It is not a matter of much difficulty to diagnose a case of carcinoma of the œsophagus when the patient is about the age at which the disease most frequently appears; when the history is negative—that is to say, when no explanation is forthcoming to account for the onset; and when the symptoms both local and general are in every way characteristic of the complaint. It is not, however, always that even such evidence is deemed sufficient, and something further is done to establish the diagnosis. Although the advisability of attempting to pass a bougie has often been disputed, most surgeons, I venture to think, nowadays would not consider their investigation of the case sufficient without resorting to that practice. Its advantages are threefold. In the first place it serves to confirm the suspicion of some obstruction; in the second it locates the seat of the disease; and in the third it may indicate to some degree its extent. It may be added further that inasmuch as, for all diagnostic purposes, the utmost gentleness is exercised, any appearance of blood after the operation would strongly suggest ulceration; and if accidentally any fragments of tissue should be dislodged and capable of being submitted to the microscopic, the diagnosis may be confirmed beyond all doubt. It occasionally happens that the evidence of an obstruction elicited by the passage of a bougie proves to be misleading. Thus it is by no means common to find a certain amount of spasm associated with malignant disease, and when this affects a part of the canal not at the seat of the disease, nor in its immediate proximity, a false conclusion of the true seat of the obstruction may be easily arrived at. Such an error in diagnosis occurred in two cases recorded by Lacombe.<sup>1</sup> In one the seat of obstruction was diagnosed as complete at a point near the cardiac orifice. At the post mortem, carcinoma was found affecting the

<sup>1</sup> *Gazette Hebdom. de Méd. et de Chir.* 2<sup>e</sup> série, tome xxii. p. 189.

œsophagus opposite the bifurcation of the trachea, while the remainder of the canal was perfectly healthy. In the second case the post mortem revealed extensive carcinoma of the stomach, with a perfectly healthy œsophagus. During life an obstruction was encountered a little below the pharynx.

The seat of the disease is often accurately localised by the patient himself. He is conscious of a certain spot where the food seems to lodge, and he is also conscious of certain sensations while the bolus passes the obstruction. Independently, however, of the passage of food, pain itself is sometimes felt, and correctly localises the focus of disease. On the other hand the patient's feelings must not always be accepted as accurately settling this point, for sometimes the pain is felt at a considerable distance from the affected area: thus it may be felt at the top of the sternum when disease is much lower. A surer means of focalising the locality of the mischief is by auscultation and by using the œsophagoscope. The latter is of most service when the disease is situated in the upper part of the canal, and the former for obstruction anywhere in the thoracic portion. In auscultation, the patient is made to swallow some fluid, and the ear is applied either directly or by means of the stethoscope to the spine. In this way various sounds may be heard indicative of the fluid passing through a constricted canal. Further, if we remember the fact pointed out by Ogston,<sup>1</sup> that the time of passages of fluids into the stomach is in the normal condition about four seconds, any increase of this period will suggest obstruction. In a case recorded by Hunter Mackenzie<sup>2</sup> the time taken was from ten to twelve seconds. This method of examination, however, is not so easy as it might at first sight appear, and requires more experience than most practitioners usually have, to enable a correct diagnosis to be made, except in the most striking cases. The œsophagoscope may prove of more service than for the mere detection of a tumour. Thus Morell Mackenzie<sup>3</sup> was enabled not only to see a growth about three inches below the cricoid cartilage, but to remove a fragment for microscopic examination. The possibility of determining with any degree

<sup>1</sup> See page 4.

<sup>2</sup> *Journal of Laryngology and Rhinology*, 1891, vol. v. p. 51.

<sup>3</sup> *Medical Times and Gazette*, 1881, vol. ii. p. 60.

PLATE IV.



Fig. 8—CARCINOMA OF ŒSOPHAGUS—The gullet is involved for about  $1\frac{1}{2}$  inch. The lower limit is one inch from the cardiac orifice. The aorta is seen laid open on the right. (*W.I.M., Glas.*)



of certainty the particular kind of tumour present is doubtful, but a tolerably correct guess can often be made. Thus the course run by a scirrhus carcinoma is usually much longer than that in the more frequently met with epithelioma. On the other hand, the rarer form of medullary cancer runs a rapid course. Again, any fœtor in the breath, or in the matter removed either naturally in vomiting or artificially by the bougie, will indicate sloughing of parts.

**Differential diagnosis.**—The distinction between carcinoma of the œsophagus and other diseases simulating it may be considered under two heads. First where the disease, whatever it may be, unmistakably involves the œsophagus; and second, where it is located elsewhere. In the former instance it is usually the condition of obstruction with its pathognomonic symptom, dysphagia, that most prominently calls for consideration and diagnosis. The various conditions which may give rise to symptoms of obstruction may exist either within or without the canal. In the latter case the tube is pressed upon by some tumour or swelling, such as aneurysm of the arch of the aorta, spinal abscess, malignant disease of neighbouring parts, &c. In all these cases there is usually but little difficulty in passing a bougie, and the symptoms peculiar to each affection are sufficient of themselves to indicate the real cause of the obstruction. Among the intrinsic affections of the canal may be mentioned stricture arising either from traumatism, syphilis, chronic ulcer, or some spasmodic nerve affection, chronic œsophagitis, paralysis, simple dilatation.

In the case of obstruction due either to a traumatic or a syphilitic stricture, the previous history of the case in each instance will largely assist in determining the nature of the obstruction. In the case of stricture following a simple ulcer of the œsophagus, there will usually be some history of previous hæmorrhages, taking place at intervals of time too distant from the actual onset of dysphagia to admit of a diagnosis of carcinoma being entertained (see Debove's case above, p. 48). In strictures of a spasmodic character, there will usually be some nerve element in the case to excite a suspicion as to its nature, and in addition the passage of a bougie while the patient is under an anæsthetic

will prove the absence of any organic obstruction. Hot water swallowed in the case of simple spasm is generally at once ejected, while in cancer it is more likely to be retained (Gant). A paralytic condition of the œsophagus giving rise to dysphagia is uncommon, and usually found in those whose strength is greatly reduced either from old age or some prolonged exhausting disease. The bougie passes easily, and so excludes the existence of any mechanical obstruction. Dysphagia from chronic œsophagitis is distinguished with difficulty from that produced by carcinoma. Occurring about the same time of life and in those who are in robust health, the diagnosis has to rest mostly in the progress of the case. Some assistance, however, may be lent towards making a diagnosis by the fact that in the inflammatory condition considerable pain is experienced in attempting to swallow hot or irritating substances; and that in the passage of a bougie great discomfort, if not pain, is complained of. Under careful treatment—by excluding all causes of irritation—rapid improvement ensues, and any further difficulty in coming to a diagnosis is removed. Simple dilatation of the œsophagus is a condition which usually arises early in life. Although accompanied with vomiting after food, the ejection does not usually take place for an hour or two. The comparatively easy passage of a full-sized bougie will serve to prove that the symptoms are not due to real obstruction.

Reher,<sup>1</sup> in an interesting paper, describes how in various ways obstruction in the œsophagus may be produced through disease of the stomach. Carcinoma affecting the cardiac end of that organ may narrow the orifice of the œsophagus, through the growth of tumour around it; or it may so deflect the normal perpendicular axis of the gullet as to cause it to form an acute angle with the stomach.

Carcinoma of the liver produces in some cases symptoms suggestive of obstruction in the œsophagus, and has been the cause of a mistaken diagnosis. (See Spasm of Œsophagus.)

Disease of the œsophagus is liable to be masked, by the reference of the symptoms to adjoining organs. The cases where these difficulties are liable to arise are those in which

<sup>1</sup> *Deutsches Archiv für Klin. Med.* 1885, Bd. xxxvi. p. 460.



the symptoms point to disease either of the stomach or of the air passages. In one case (Smith's) already referred to (p. 65), the symptoms of the œsophageal disease were so like those arising from disease of the stomach, that the diagnosis made was carcinoma of that organ. In Roosevelt's case (p. 61) also, the symptoms were so strongly referable to the stomach that a diagnosis of chronic gastritis was made. Page<sup>1</sup> reports the case of a man aged 55 years who presented the symptoms of tuberculous disease of the cervical vertebræ. The head was bent forward, and the neck presented a projection behind. There was loss of power in the extremities, and retention of urine. No evidence of obstruction of the œsophagus. At the post-mortem examination carcinoma of the gullet was found encircling its whole circumference, but not narrowing the lumen. A mass of growth had made its way through the intervertebral foramina on the right side into the spinal canal, and caused softening of the cord.

In the case of symptoms suggesting disease of the air passages it not infrequently happens that cough is the misleading symptom, or aphonia, as in Finlayson's case (p. 66), where the diagnosis made was 'advanced laryngeal phthisis with ulceration.' Gaucher<sup>2</sup> records a case where the early symptoms were of such a pronounced laryngeal character, that tracheotomy had to be performed. Subsequently dysphagia and other symptoms of œsophageal stricture manifested themselves, and it was discovered that the initial symptoms were due to an early involvement of both recurrent laryngeal nerves. In cases of supposed laryngeal trouble the laryngoscope will often assist in eliminating affection of that region. It may be mentioned lastly that the seat of pain may sometimes prove misleading. In Finlayson's case abdominal pain was a most prominent and puzzling symptom; and was due, as shown at the post mortem, to a secondary nodule in the body of the twelfth dorsal vertebra.

These varied and exceptional conditions are only mentioned in order to render the surgeon alive to the fact of their existence, so that when obscure and unaccountable symptoms do

<sup>1</sup> *Medical Press and Circular*, 1892, vol. i. p. 413.

<sup>2</sup> *Journal of Laryngology and Rhinology*, 1890, vol. iv. p. 512.

arise he may not be misled into attributing them to causes which, on the surface, they seem to suggest.

---

## CHAPTER VIII

### CARCINOMA (*continued*). PROGNOSIS AND TREATMENT

**Prognosis.**—In the majority of instances death takes place from exhaustion within a year from the onset of the first symptoms. Often the period is much less. In Mackenzie's hundred cases the average length of life, after the first symptoms were unmistakably manifested, was eight months—the maximum being sixteen months and the minimum five weeks. In a case reported by Owles,<sup>1</sup> the patient lived for three years after the first appearance of symptoms. The many accidents which may happen in the progress of the disease render it impossible to venture upon anything but the merest speculation as to the length of life. Hæmorrhage, if not at once fatal, must be considered as a grave forerunner of not very distant dissolution. Perforation into the air passage will cause death within a week or two. Barring such accidents, life may be measured by the general physical conditions of the patient. Towards the latest stage of the disease considerable improvement sometimes takes place in the patient's ability to swallow. This is due to some dislodgment of the growth, and is of course only temporary improvement. To what extent, however, such improvement may take place is illustrated in a case recorded by Henschell.<sup>2</sup> Two days after the passage of a bougie the patient spat up two large quantities of blood. Soon after that his condition began to improve, and he took milk freely. He gained twenty-five pounds in weight, and remained comfortable till three days before death, when he developed lung symptoms from perforation. In somewhat striking contrast to the result of passing a bougie in this case, I may allude to a rather unusual sequel recorded by Fort.<sup>3</sup> The patient had been accustomed to pass the bougie himself,

<sup>1</sup> *Medical Press and Circular*, 1886, N.S. vol. xlii. p. 427.

<sup>2</sup> *New York Medical Record*, 1883, vol. xxiv. p. 635

<sup>3</sup> *Gazette des Hôpitaux*, 1883, vol. lvi. p. 1010.

and on this occasion when attempting to do so, suddenly expired. As no important structure had been perforated, Fort's explanation was that either the vagus or the œsophageal plexus had been irritated, and so reflexly stopped the heart, the patient dying from syncope.

Where it is possible to adopt some conservative measures in the way of treatment, life may be considerably prolonged. The question of the total extirpation of the disease is not one which at present it is possible to take into consideration in giving a prognosis. While operations have been suggested and endeavours made for the excision of the tumour, whether located in the cervical or the thoracic portion of the œsophagus, nothing is yet sufficiently settled to enable any opinion to be expressed either for or against the prolongation of life after any such attempt.

**Treatment.**—In a disease which is practically incurable the treatment consists in such measures as will most conduce to the prolongation of life and the relief of suffering. It will simplify the discussion of the subject to consider the treatment of œsophageal carcinoma under the four stages into which the progress of the disease may be divided. These are,

(1) Early symptoms of dysphagia, but with ability to swallow solid food. (2) Inability to swallow solids, but ability to take fluids. (3) Aphagia, or total inability to take fluids. (4) Complications such as arise from fistulous communications with air passages &c.

(1) With comparatively few exceptions—such as those already alluded to, where the onset of the dysphagia is sudden and severe—the condition most frequently met with is that of some slowly increasing difficulty in deglutition. The patient has, as a rule, already learnt the secret of how best to get solids most easily into the stomach. If not previously mixing well the solid with some fluid, he immediately swallows a mouthful of fluid after taking the solid 'to make it go.' The treatment therefore at this comparatively early stage of the disease consists almost solely in a careful selection of suitable foods. The foods must be of the most nutritious kind, free from irritating properties, and without such condiments as pepper and mustard. They should also be of such a

character and consistency that they can easily mould themselves to the narrowed and distorted passage through which they have to pass. Taken in small mouthfuls, and either well masticated or previously mechanically broken up, a patient will frequently be able to make a good meal, when without such simple precautions but little solid food might be swallowed. The foods which will be found to best subserve these requirements will be—among those of a nitrogenous kind—oysters, boiled or stewed tripe, boiled calf's or sheep's head, stewed pig's and calf's feet, eggs, &c.; and—among those of a farinaceous kind—porridge, arrowroot, boiled sago, ground rice, &c. Occasionally, as pointed out by B. W. Richardson,<sup>1</sup> it will be found that cold materials are taken better than warm or hot. As the time approaches when even these bland foods are beginning to pass with difficulty, the question of instrumentation arises. Now will be the time for the systematic passage of bougies. Twice a week, or oftener, a bougie should be passed. Such a practice will serve to extend the time during which a patient will be enabled to continue taking solid foods. When, however, this means fails, we have to face the second stage, that of total inability to swallow solids.

(2) Patients who are reduced to depend solely upon fluids for nutrition rapidly emaciate, and the question of treatment no longer turns upon the kind of nourishment to be administered, but upon certain considerations connected with the question of operative interference.

So much success has attended in recent years the use of tubes retained for lengthened periods, that few surgeons, *at this stage* of the disease, would venture upon more serious operative measures. Those who have tried this method are loud in its praise when compared with the alternative of gastrostomy; and those who advocate the latter method, it must be confessed, frequently do not appear to have tried the former.

While the use of tubes for purely feeding purposes has long been in vogue, it is only in comparatively recent years that the idea of inserting a tube and allowing it to remain permanently *in situ* has come into practice. Prior to 1881

<sup>1</sup> *Asclepiad*, 1886, vol. iii. p. 65.

PLATE V.



Fig. 9.—CARCINOMA OF THE LOWER END OF THE ŒSOPHAGUS.—The canal, to the extent of  $1\frac{1}{2}$  inch, is converted into a thick-walled cylinder with a narrow calibre. There is dilatation of the gullet above, which measured in circumference about  $3\frac{1}{2}$  inches. (*W. I. M., Glas.*)



Morell Mackenzie<sup>1</sup> speaks of having for years used a short tube, allowing it to remain in position for five or six days and then removing it. But it was in this year that Krishaber, at the International Medical Congress, gave a renewed impetus to this method of treatment by introducing cases where the tubes had been worn for prolonged periods. Since this numerous surgeons, among them Durham, Croft, Symonds, Berry, Renvers, Gersuny, and others, have recorded cases, and improved in certain details the method of treatment by permanent tubage.

To Symonds<sup>2</sup> in this country must be attributed the most active advance, both as regards the number of patients he has successfully treated and the manner of procedure. His exhaustive and interesting papers should be consulted for a fuller discussion of the subject than can be entered upon here. I shall, however, quote his directions for the use of the permanent short tube.

‘First ascertain by a large bougie the exact position of the stricture—i.e. the number of inches from the teeth; then pass the largest conical bougie possible, and judge by this the size of the tube to be used. Fitting now the introducer’ (made of whalebone and enclosed by a gum elastic sheath), ‘mark on it the distance to the stricture, or make a knot in the silk’ (the cords which are attached to the upper dilated part of the tube), ‘and insert with the head thrown back. When it has entered the stricture send the tube down slowly, till arrested by the funnel, and withdraw the introducer. The silk being kept taught, the tube is kept in contact with the introducer. . . . It is essential to avoid *hurry* and *force*, to withdraw at once if there be a spasm, and to keep in the *median line*. The silk is now tied round the ear, and fixed behind by a piece of strapping.’

The time during which a tube should be retained will depend upon various circumstances. After a week or ten days it will sometimes be found that the first tube can be removed and replaced by another of larger calibre, and this process may be continued at similar intervals until the largest size is reached. When a tube of this size has been kept in place

<sup>1</sup> *Diseases of the Throat and Nose*, vol. ii. p. 22.

<sup>2</sup> *Lancet*, 1889, vol. i. p. 622.

for a week or two, it may be removed, and the patient allowed to swallow some solid food, which otherwise he is unable to



FIG. 10.—SYMONDS'S SHORT TUBE FOR CANCER OF THE ŒSOPHAGUS

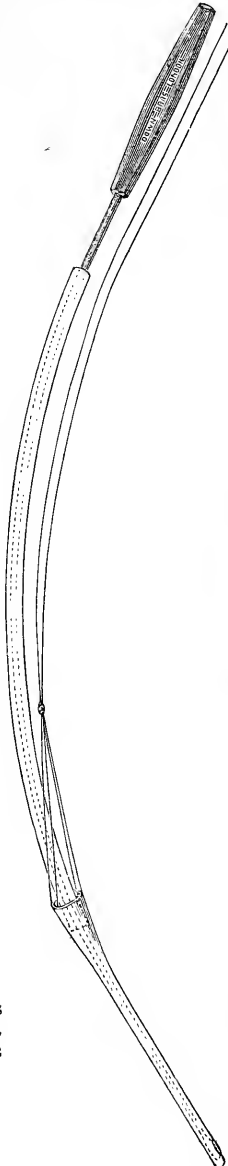

FIG. 11.—SYMONDS'S SHORT TUBE WITH INTRODUCER READY FOR USE

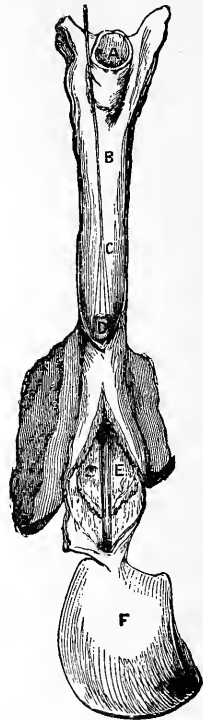

FIG. 12.—SYMONDS'S SHORT TUBE *in situ*

A, Upper aperture of larynx; B, œsophagus held open from behind; C, silk thread by which the tube is retained in position and withdrawn; D, wide upper end of the tube above the stricture; E, narrower lower part of tube below the stricture; F, cardiac end of stomach.



do. In the use of these short tubes there is the possible danger of the tube becoming disconnected from its cords, either from the latter being severed by the friction of the teeth, or breaking in any forcible endeavour at extraction. An instance of the former accident is recorded by G. H. Rodman.<sup>1</sup> The tube remained in for twenty-four weeks, when the patient accidentally coughed it up. Symonds instances one of his own cases, where he was obliged to force the tube into the stomach, the cord having been broken in an endeavour to withdraw a plugged tube. After the death of the patient from the disease, the tube was found in an undigested condition in the duodenum. He also refers to another case, where sixteen days after the tube had passed from its position it appeared in the fæces. In both Rodman's and Symonds's cases the accident was apparently preventable. Rodman in a second case used 'gimp' instead of silk, and when it passed between the teeth, ran the gimp through a piece of rubber drainage tube. In Symonds's case the accident was owing to the tube becoming blocked; and by the patient's efforts, carried so far down, that the cords were put unduly on the stretch, and would not bear the additional strain exercised in trying to withdraw the tube. The narrower the tube used, the greater needs to be the care taken with the food swallowed. In all cases it must be of a perfectly fluid character.

*Gersuny's*<sup>2</sup> *method of permanent tubage*.—In this method of treatment the tubes can neither be termed examples of the 'short' kind nor of the 'long.' They pass from the stomach to the upper orifice of the œsophagus. Two ordinary rubber drainage tubes are taken and stitched together, the sizes selected being suitable for the case in hand. The upper ends are cut in such a way as to leave a kind of ribbon-shaped strip extending from the upper part of the œsophagus to the posterior nares. To each end is fixed a thread which passes through the corresponding nasal cavity, and the two are tied together in front of the septum. The tubes extend the whole length of the œsophagus, and the two ends in the stomach are so cut as to have the appearance of a swallow's tail. This particular shape effects a sort of valvelike action whereby

<sup>1</sup> *Brit. Med. Journ.* 1889, vol. i. p. 1169.

<sup>2</sup> *Wiener Med. Wochenschrift*, 1887, No. 43, p. 1393.

food is prevented from regurgitating. Gersuny adopted the method in two cases. One was a case of carcinoma, and the tube was retained for five weeks.

It may be added here that some amount of success has been attained in the dilatation of malignant stricture by the use of laminaria. Senator,<sup>1</sup> of Berlin, has used this form of tent. It is fixed on to the end of a bougie and passed into the stricture, where it is left for half an hour or longer. Being secured by a piece of silk, it is easily withdrawn. The method of treatment is, however, more suitable for non-malignant cases, where it will be more fully referred to.

(3) In hospital practice it frequently happens that not a few of the patients who present themselves for admission are cases of aphagia or complete inability to swallow fluids. In these instances the patients are much emaciated; greatly reduced in strength, and show signs of sinking from starvation. When thus first seen it will often be found impossible to pass the smallest bougie, and no repeated attempts should be made for a day or two. The patient should be confined to bed, kept warm, and fed by nutrient enemata containing opium. To quench thirst a little ice should be sucked, but warm water may be given by rectal injection. On the second or third day a renewed endeavour should be made to pass a bougie; but prior to the attempt subcutaneous injections of morphia should be given and the patient placed under the influence of an anæsthetic. If a bougie can be passed, then further dilatation may be effected, until a tube can be introduced, and the treatment by that method continued. Failing, however, to obtain any passage past the obstruction, the only alternative is gastrostomy if the disease is situated in the thoracic portion of the canal, or œsophagostomy if the disease is sufficiently high up to admit of the opening being made below it.

(4) While I have placed as a fourth stage of the disease the existence of complications through the extension of the growth to neighbouring parts, it must be remembered that these may arise at any period in its progress, although more frequently appearing after the disease has lasted for some time. Whether, however, arising early or late, the treatment will consist

<sup>1</sup> *Brit. Med. Journ.* 1889, vol. i. p. 1417.

either in the use of the long tube permanently retained or in the performance of gastrostomy. When a choice exists, those surgeons who have had experience of the former measure will select it in preference to the latter, and gastrostomy will only be adopted as a *dernier ressort*. The 'long' tube is of most service in cases where ulceration has taken place into the pleural cavity, lungs, bronchi, or trachea, and in some cases where the disease is situated so high up that a 'short' tube cannot be worn. Again, where there is reason to believe, from the offensiveness of the breath and other symptoms, that the disease is extensive and that the wall of the œsophagus is both sloughing and thin, the 'long' tube will prove of value.

The 'long' tube passes from the stomach out through the mouth or the nostril. If no inconvenience is associated with its retention, it may be kept in for lengthened periods. Thus in four of Krishaber's<sup>1</sup> cases the respective periods of retention were 305 days, 46 days, 167 days, and 126 days. In one of Symonds's cases it was worn for four and a half months. As all food is injected into the stomach through the tube, there is an absence of those troublesome symptoms which would arise from the escape of material through any fistulous openings into the air passage and elsewhere. If for any reason, such for example as undue irritation, it be found impossible to retain the tube permanently, it must then be used simply as a feeding tube, to be removed and introduced as required.

While special 'long' tubes can be obtained, it is of service to the surgeon to know that for all practical purposes and in cases of urgency a very simple device will suffice. These are Symonds's<sup>2</sup> directions for the construction of a 'long' tube 'in a few minutes': 'Take a piece of red rubber drainage tube with a thin wall and a wide bore, and about eighteen inches long. Cut one end obliquely and sew it up, thus obtaining a conical end; next cut a large eye in the tube about an inch from the extremity; or two openings may be made. To prevent the introducer catching in the point, fill up the interior where stitched with a plug of cotton wool. Oil the interior of the tube and introducer thoroughly. Insert this with the whale-

<sup>1</sup> *Transactions of the International Medical Congress*, 1881, vol. ii. p. 393.

<sup>2</sup> *Lancet*, 1889, vol. i. p. 622.

bone introducer ; . . . the outside diameter of the tube need not be more than a No. 12 catheter.'

One of the most troublesome objections to the use of a permanent long tube is the irritation, resulting sometimes in ulceration, which takes place on the posterior surface of the cricoid, due to the constant pressure of the tube on that part. This is, however, reduced to a minimum by using as soft and flexible tubes as possible.

I have left for separate and fuller consideration the question of operation. The œsophagus, like almost every other region of the body, has not escaped the surgeon's endeavour to totally extirpate the disease. Hence scattered cases are found where the operation of removing portions of the œsophagus has been performed. Originally suggested by Billroth<sup>1</sup> in 1872, and successfully performed by him on dogs, it was first apparently executed on man by Kappeler; but not till 1878 was the operation successfully carried out by Czerny, who in a private letter to Morell Mackenzie<sup>2</sup> stated that the patient lived for a year after the operation. Wilms,<sup>3</sup> of Boon, reports the case of a man aged 46. He died of hæmorrhage thirteen days after the operation. In these instances the disease was located in the cervical portion of the canal, but a bolder procedure has recently been suggested by Nassiloff<sup>4</sup> of excising the part when situated within the thoracic region; no case attended with success has, so far as I can ascertain, been recorded.

Other operative measures dealing directly with the disease are internal œsophagotomy, and cauterisation or excision with the scissors when the disease is situated high up. Morell Mackenzie<sup>5</sup> records a case where by the aid of the œsophagoscope he was enabled to remove projecting masses of the growth and so allow of the passage of a tube. Internal œsophagotomy has been performed by Schiltz.<sup>6</sup> In one case the patient was given great relief. The operation was repeated three times, but no improvement occurred after the last trial. At the post

<sup>1</sup> *Archiv für Klin. Chir.* 1872, Bd. xiii. p. 66.

<sup>2</sup> *Diseases of the Throat and Nose*, vol. ii. p. 97.

<sup>3</sup> *Journal of Laryngology and Rhinology*, 1891, vol. v. p. 208.

<sup>4</sup> *Annual of the Universal Medical Sciences*, 1889, vol. iv. G—38.

<sup>5</sup> *Diseases of the Throat and Nose*, vol. ii. p. 94.

<sup>6</sup> *Berliner Klin. Wochenschrift*, 1882, p. 764.

mortem it was found that a tumour was situated at the seat of obstruction, and that the parts failed to gape after the last incision. It is doubtful whether the operation should ever be attempted for cases of obstruction due to carcinoma. It rarely happens that a sufficient amount of dilatation cannot be obtained by the passage of bougies, and as no permanent good effects can be expected, there seems little justification in attempting a measure which is not altogether free from immediate danger.

The two operations worthy most consideration are those of œsophagostomy and gastrostomy. Both have the same object in view, to obtain an artificial entrance into the stomach for the administration of nourishment. The former operation is performed when the disease is located high up, and the opening in the œsophagus being thus below the seat of obstruction, a feeding tube can be easily passed from the wound into the stomach. Occasionally the œsophagus is opened above the level of the disease, the object then being to facilitate the passage of a tube which otherwise would be conducted with pain or difficulty through the natural orifices.

The operation of gastrostomy is by far the more frequently adopted measure, and considerable differences of opinion exist among surgeons as to the period when it should be performed. As already indicated, permanent tubage has to some extent replaced this operation, and those who practise this more conservative measure do not consider the question of opening the stomach till the latest stage of the disease. On the other hand, those who advocate gastrostomy do so at a much earlier stage. Although at any time the risks of the operation are grave, they are nevertheless materially diminished when the patient is not very much reduced in strength. Therefore, when performed early and with all proper precautions, a reasonable amount of success may be expected. David Newman<sup>1</sup> records four consecutive successful cases. Contrasting, however, the operation successfully performed with the alternative of permanent tubage, it must be confessed that in the majority of instances the patient with a tube in the œsophagus is, in various ways, in a more comfortable position than one with an artificial orifice in the stomach.

<sup>1</sup> *Lancet*, 1892, vol. i. p. 7.

CASE XXXV.—*Carcinoma of the œsophagus: gastrostomy: survival for 407 days.*

W. O., aged 45, had for four years suffered from 'indigestion,' and for thirteen weeks had been unable to take any solid food. The difficulty in getting food down had steadily increased, and for two days everything taken had 'come up again.' He had suffered acutely from hunger for some days. He was much emaciated (from weighing 10 st. he was reduced to 7 st.), but was fairly strong and had no physical signs of disease other than an obstruction at the lower end of the œsophagus, which was discovered by the passage of a bougie. Water and milk returned at once when he attempted to take them.

*Operation.*—The first stage of gastrostomy was performed on October 27, 1890, strength being maintained by warmth, rest, and nutrient enemata. The cardiac end of the stomach and its anterior wall were extensively infiltrated by malignant growth. On October 30, three days afterwards, the operation was completed by opening the stomach, and the patient was fed for the first time. A week after the operation he sat up and dressed, having suffered neither pain nor constitutional disturbance; he was still very hungry. A wineglassful of whisky, a pint of milk, and a raw egg, administered by the opening through a tube and funnel, relieved the feeling of hunger, which never returned in the same aggravated form again. He went home on November 13. Six months after the operation he had gained 1 st. 14 lbs. in weight. In May he went to his work as a tailor, and 'felt better and lightsomer than he had done any time the last three years.' The gastric fistula did not leak, and occasioned no trouble except at the moment of withdrawing the tube, when fluids would escape without care. From May till August 1891 he worked as a tailor, when he had to give up on account of a cough. On December 8, 1891, he died, apparently from infiltration of the lungs by the malignant growth. No post mortem could be obtained. (Rutherford Morison, 'Brit. Med. Journ.' 1892, vol. i. p. 963.)

**Sarcoma.**—Except as pathologically distinguished from carcinoma, sarcoma has no particular clinical features peculiar to it. The few cases of the disease that have been recorded were mostly mistaken during life for carcinoma, and it has been only after death and as the result of careful microscopical examination that the true nature of the disease has been discovered.

So few are the instances recorded that almost every text-book dealing at any length with diseases of the œsophagus refers back to the same cases. Hence Rosenbach's<sup>1</sup> and Chapman's<sup>2</sup> are universally quoted. The latter's case, I

<sup>1</sup> *Berliner Klin. Wochenschrift*, 1875, vol. xii. p. 519.

<sup>2</sup> *American Journal of the Medical Sciences*, 1887, N.S. vol. lxxiv. p. 433.

venture to think, is not altogether free from question. The patient, a woman aged 45, had suffered from dysphagia for seven months prior to her death. Her symptoms were those usually present in carcinoma, and the examination with the microscope of the material 'hawked' up did not apparently suggest any other opinion. After death the diagnosis of sarcoma seems to have been based solely upon macroscopical appearances, as no positive statement is made that the diseased part was examined microscopically. One of the most unequivocal examples of sarcoma of the œsophagus was shown at the Pathological Society of London by Lauriston Shaw.<sup>1</sup> The specimen was that of an ulcer involving the upper part of the œsophagus for about three inches, its limit above being a point about an inch below the cricoid cartilage. The ulcer had well-defined edges and encircled the gullet. Perforation had taken place into the trachea. The patient from whom the specimen was removed was a female aged 38. She had suffered from dysphagia for six months, and died one week after admission into the hospital. The specimen was submitted to a committee of the society, which corroborated in its report the original statement that the growth was a sarcoma consisting of round and oval cells. At the same society, two years earlier, Targett<sup>2</sup> showed a specimen of a sarcoma taken from a man aged 70 years who had suffered from dysphagia for the last three months of his life. The symptoms present were those usually observed in carcinoma. The tumour found at the autopsy was attached to the anterior wall of the gullet, and in the recent state measured four and a half inches in length by two and a half inches in breadth, and about an inch and a half in thickness. Its upper border was opposite the bifurcation of the trachea, and below it reached very nearly to the cardia. It was somewhat constricted at its attachment, and found to take its origin from the submucous coat. The free surface of the tumour was in a state of ulceration and sloughing. In consistency it was firm, and resembled somewhat encephaloid carcinoma. Microscopically it was seen to be composed of round, oval, spindle, and tailed cells, without any appearance of a

<sup>1</sup> *Trans. Path. Soc. Lond.* 1891, vol. xlii. p. 90.

<sup>2</sup> *Ibid.* 1889, vol. lx. p. 76.

stroma. H. D. Rolleston<sup>1</sup> records a case of round-celled sarcoma. Secondary growths were found to involve many ribs, the right iliac bone and the middle fossa of the skull. The primary growth involved the lower three inches of the gullet, thickening it so as to cause considerable constriction.

A case of lympho-sarcoma of the gullet in a boy 4 years old is reported by Stephan.<sup>2</sup> There had been dysphagia, pain in swallowing, and vomiting. The patient died under increasing œdema and repeated paroxysms of dyspnœa. At the autopsy a tumour was found close to the cardia measuring five-eighths of an inch in length and three-eighths of an inch in thickness. The œsophagus admitted the passage of a moderately sized catheter.

Little can be said or need be said regarding the symptoms of sarcoma of the œsophagus. When it is remembered how in their pathological aspects both carcinoma and sarcoma resemble each other, how both in their progress tend towards growth and destruction, it will be understood that what is said of one could equally be said of the other. Hence we may expect that sarcoma attacking the gullet will produce symptoms precisely similar to such as arise in carcinoma; and such few cases as are recorded tend to show the truth of the supposition.

---

## CHAPTER IX

### NON-MALIGNANT OR CICATRICIAL STRICTURE

THE stenosis which follows from malignant disease, and which has just been discussed, differs in two important particulars from the affection now to be dealt with. In the former instance the contraction of the canal is associated with progressive growth and destruction of tissue, while in the latter the sole pathological feature is the cicatricial contraction. Another point of distinction rests in the nature of the cause. While in malignant disease we are ignorant of what is the origin of the process which leads to obstruction, in the case of purely

<sup>1</sup> *Trans. Path. Soc. Lond.* 1893, vol. xlv. p. 65.

<sup>2</sup> Solis-Cohen, *Annual of the Universal Medical Sciences*, 1892, vol. iv.



cicatricial stricture we know it to be due to some definite influence.

**Etiology.**—Many of the causes which give rise to cicatricial contraction have already been alluded to, but the subject of stricture was only briefly indicated as a possible sequel to the affection. The causes already described are traumatism, chronic œsophagitis, simple ulcer, syphilis, and tuberculosis. To these may be added such rarer causes as smallpox, repeated attacks of vomiting, the suppression of certain discharges or skin eruptions, prolonged spasm, and possibly rheumatism and gout.

**Stenosis from traumatism.**—In various ways injuries to the œsophagus, received externally or internally, may lead to stricture. Thus it may be as the result of chronic inflammation: of destruction of tissue at the time of the accident; or of ulceration taking place subsequently. By far the most frequent cause is that which results from ulceration. This is usually effected in one of two ways. Either it is due to prolonged impaction of a foreign body such as a bone, a fruit stone, or other such sharp and irregularly shaped bodies, or, as is more frequently the case, it results from swallowing some caustic alkali or acid.

Ulceration which results from an impacted body is of course limited to the seat of impaction. The depth and superficial extent of the process vary according to the size and general nature of the impacted body. The form of stricture which results will similarly be limited. The exception in this class of cases is where endeavours at extraction, whether successful or otherwise, have led to injuries of other parts of the œsophagus; so that instead of one stricture two or more may be met with. Thus Morejon<sup>1</sup> has recorded the case of a patient aged 23 who, when 8 years old, swallowed a large needle. Efforts at withdrawal led to injury of the walls of the gullet at another spot, so that two strictures were found to exist, one at the level of the diaphragmatic ring and another opposite the first dorsal vertebra.

Strictures which result from swallowing acids, caustic alkalis, or boiling fluids may be single, but are not infrequently multiple; and even when single they are usually much more extensive and much more irregular than those following other

<sup>1</sup> *Journal of Laryngology and Rhinology*, 1890 vol. iv. p. 19.

forms of traumatism. When it is remembered how all parts of the canal are subjected to the cauterising influence of the fluid, it will at once be gathered how extensive may be the destruction of tissue and subsequent ulceration, and how irregular its distribution. There are, however, parts more frequently and more severely attacked than others. These are the more constricted and rigid portions of the canal, such as opposite the bifurcation of the trachea, at its commencement near the cricoid cartilage, and at its termination near the cardia. The following table of twelve cases compiled by Weinlechner,<sup>1</sup> where the seat of stricture was accurately determined at the post mortem, are also interesting as showing the extent and number of strictures which may be present.

In 8 cases the thoracic part was alone implicated.

In 1 case there were three strictures.

„ 2 cases there were two strictures.

„ 5 cases there was one stricture.

In 2 cases both thoracic and cervical regions were implicated.

In 1 the cervical stricture was opposite the cricoid.

„ „ „ „ „ „ 4 cm. below the cricoid.

In 1 case the cervical part was alone involved.

In 1 case the entire œsophagus was moderately affected.

12

A case somewhat similar to the last of Weinlechner's, only more severe, has been recorded by Mackenzie.<sup>2</sup> In this instance the œsophagus was bound to the prevertebral muscles by bands of dense fibrous tissue, rendering its separation from the surrounding parts very difficult. Barely half an inch below the cricoid cartilage the stricture commenced, and extended downwards to within an inch of the cardia. The walls of the gullet throughout the whole of the strictured portion were enormously thickened, the cut edge in some places being one-eighth of an inch deep and very tough. The narrowest part of the stricture was situated above and consisted of four longitudinal ridges.

**Stenosis from chronic œsophagitis.**—Rare as is chronic œsophagitis, still rarer is the sequel to it—stenosis. The kind of stricture which results from this affection resembles that which follows on chronic urethritis. The inflammatory

<sup>1</sup> *Wiener Med. Wochenschrift*, 1880, p. 33.

<sup>2</sup> *American Journal of the Medical Sciences*, 1883, N.S. vol. lxxxv. p. 436.

process leads to a thickening of the mucous membrane and submucous tissue, with changes extending sometimes into the muscular coat. The parts thus thickened by infiltration and new-formed tissue contract and lead to a narrowing of the canal.

**Stenosis from simple ulcer.**—The variety in form of this kind of ulcer naturally entails a corresponding variety in the strictures resulting from it; thus a cicatricial ring may be produced, or simply a fibrous band coursing for a variable extent transversely or in some other direction. Debove's<sup>1</sup> case already quoted may be instanced in illustration. The diagnosis made during the life of the patient was corroborated at the post mortem two years later. It was then found that a cicatricial fibrous band existed at a distance of two inches from the cardia, and that an ulcer also was seated in the stomach near its lesser curvature.

**Stenosis due to syphilis.**—Within recent years numerous cases have been recorded of stricture of the œsophagus due to syphilis. Inasmuch as gummata<sup>2</sup> have been found in the lining wall of the gullet, it is only reasonable to suppose that, as in other parts of the body, they may break down and give rise to ulceration, which in the process of healing will lead to stricture. Syphilitic stenosis of the œsophagus has been dealt with at considerable length in a paper by Lubinski,<sup>3</sup> who also refers to numerous other instances of the affection.

There is little that can be said to be specially characteristic of this kind of stenosis. In almost all instances the diagnosis of the cause has rested either upon an unmistakable history of syphilis some years previously, or the existing evidence of such an attack in lesions in other parts of the body. A case is recorded by Kempe,<sup>4</sup> where there was a tight stricture about four inches down. The patient had extensive destruction of the hard and soft palate, uvula, &c., and a deep sloughy pre-vertebral ulcer on the posterior wall of the pharynx. In a case of Potain's<sup>5</sup> the diagnosis was based upon the presence

<sup>1</sup> See above, page 48.

<sup>2</sup> Wilks and Moxon, *Anatomical Pathology*, 2nd edit. p. 366.

<sup>3</sup> *Berliner Klin. Wochenschrift*, 1883, vol. xx. p. 501.

<sup>4</sup> *Brit. Med. Journ.* 1890, vol. ii. p. 1480.

<sup>5</sup> *Journal of Laryngology and Rhinology*, 1887, vol. i. p. 412.

of paralysis of the motor oculi muscles and the absence of symptoms suggestive of any other cause. In two of Lubinski's cases, contained in his paper above alluded to, there was a well-marked history of syphilis of some years' duration, with, in addition, in the one case, a small scar on the uvula, and in the other a gumma on the tongue. The age of the first patient was 29 years, and that of the second 54 years. In both, also, the diagnosis was assisted by the absence of the symptoms suggestive of any other cause, and it was subsequently confirmed by the amenability of the stricture to the influence of iodide of potassium and the passage of bougies.

CASE XXXVI.—*Syphilitic stenosis of the œsophagus.*

A man aged 29 years was admitted to the University Poliklinik with difficulty in swallowing solid food. His trouble had existed for three weeks. He denied having swallowed at any time caustic fluids or a foreign body. On examination of the throat a cicatrix was seen in the uvula which caused it to deviate to the right. A medium-sized sound passed easily as far as the sixth dorsal vertebra, but any further progress was checked. A moderately fine bougie could, however, be passed. Auscultation about this part revealed a loud splashing noise followed by a slight regurgitation, when, after a few seconds, the material passed into the stomach with a 'cooing sound.' The possibility of malignant disease was excluded owing to the age of the patient and the absence of any cachectic signs. The man stated that ten years before he had had a sore on his penis, followed by a rash and sore throat. These symptoms disappeared under treatment at the time. The existence therefore of the cicatrix on the uvula, the history of syphilitic infection, the absence of any evidence suggestive of other causes, led to the opinion that the stricture was syphilitic. Iodide of potassium was administered and bougies passed. The patient ultimately recovered. (Lubinski, 'Berliner Klin. Wochenschrift,' 1883, p. 501.)

**Stenosis from tuberculosis, &c.**—Stenosis arising from other causes than those just described is so extremely rare that it needs little more than a passing notice.

Konrad Zenker<sup>1</sup> records an example of stricture from tuberculosis. It occurred in a patient aged 38 years, who for four years had suffered from repeated attacks of violent hæmoptysis. For about two months there had been increasing difficulty in swallowing. A stricture was detected opposite the cricoid cartilage. After the death of the patient

<sup>1</sup> *Deutsches Archiv für Klin. Med.* 1895, Bd. lv. p. 414.

a superficial ulcer was found, the base of which consisted of cicatricial tissue surrounding the entire circumference of the canal. A microscopical examination of the ulcer and surrounding parts revealed the typical structure of tubercle and the presence of tubercular bacilli.

Voigt<sup>1</sup> records the case of a woman in whom stricture followed upon repeated vomitings during her first and only pregnancy. The history of the case, however, it was thought, pointed rather to some slight rupture or laceration during one of the attacks.

A somewhat unusual form of stricture is described by Audry.<sup>2</sup> Two cases are reported which were supposed during life to have been cancerous. They were discovered, however, by histological examination to be due to simple hyperplasia of the muscular coat.

Occasionally cases occur where no cause can be ascribed; the symptoms have come on insidiously, and finally there is well-marked evidence of a cicatricial stenosis. In some of these cases the patients have been subjects of rheumatism or gout.<sup>3</sup>

Under the heading of 'Simple Stenosis' cases have been recorded where it was found that the stricture consisted in a localised narrowing of the mucous and submucous lining of the canal, without any evidence of traumatism or cicatricial tissue. Franks<sup>4</sup> reports such a case and refers to nine others. In this particular case the author successfully excised the narrowed part, leaving, however, the unaffected muscle wall untouched.

**Symptoms.**—The symptoms of stricture of the œsophagus dependent upon any of the causes above mentioned are almost solely connected with progressive dysphagia. At first there is the difficulty of swallowing solids. The patient finds it necessary to moisten the food with fluid, or after each effort at deglutition to swallow a mouthful of liquid to make the bolus go down. As the canal narrows solids can no longer be taken and only liquids will pass, till finally in the severest

<sup>1</sup> *Medical and Surgical Reporter*, 1883, vol. xlviii. p. 45.

<sup>2</sup> *Journal of Laryngology and Rhinology*, vol. ii. p. 241.

<sup>3</sup> *Ingals, New York Medical Record*, 1890, vol. i. p. 1.

<sup>4</sup> *Brit. Med. Journ.* 1894, vol. ii. p. 973.

cases nothing can be got into the stomach past the constriction. Concomitant with the difficulty in deglutition is the occasional return of the food by the mouth. The patient vomits at variable intervals of time after taking something that will not pass through the stricture. If the stricture is situated high up, vomiting takes place almost immediately; while if lower down, and especially if associated with some dilatation of the canal above, the return is delayed. Independently of taking food, the patient occasionally 'hawks' up quantities of clear viscid material, which is saliva that has been swallowed mixed with the mucoid secretion from the lining membrane of the œsophagus, both having collected and lodged above the seat of obstruction. The gradual diminution in the amount of food taken into the stomach leads to progressive emaciation, with, in the earlier stage, the painful feeling of hunger, and in the later, that of increasing weakness. Pain, not extending beyond a feeling of discomfort in some cases, is usually experienced in the region of the stricture, and felt either about the epigastrium, behind the sternum, or between the shoulder blades. Occasionally the pain is referred to more distant parts. The smallness in quantity of the food which enters the stomach causes gastric disturbances and troublesome constipation.

**Differential diagnosis.**—The differentiation of the symptoms of obstruction due to cicatricial stricture of the œsophagus from those dependent upon malignant disease, upon spasmodic affections, and upon external pressure, will mostly depend upon the relative distinctness of the other associated symptoms. The age and sex of the patient, in the absence of any history of traumatism or syphilis, will reasonably suggest that symptoms of obstruction in a man over 40 years of age are due to malignant disease; and, further, the presence of any blood either in the ejecta, or on the bougie after its use, will tend to corroborate the opinion. The mere passage of a bougie will also serve in many cases to eliminate obstruction due to spasm and pressure from without. The instrument being passed when the patient is under the influence of an anæsthetic, there will be an absence of any sensation of 'grip' such as is experienced in a purely cicatricial stricture. Where obstruction is due to pressure from without, such for instance as occurs in some cases of aneurysm, there will probably exist other symptoms

peculiar to the disease itself. Cases will occur where the symptoms at the time are not sufficiently distinctive to admit of a definite diagnosis being made. The progress of the case will, however, tend sooner or later to clear up any obscurity.

**Diagnosis.**—To determine the cause of the stricture, its seat, and particular nature, are all points of considerable importance in connection with the proper treatment of the case. The history of the case should in most cases lead to a correct diagnosis of its cause. Thus no difficulty will arise in this respect when a history of swallowing some caustic fluid is obtained, or when there exist about the body secondary or tertiary scars the result of some previous attack of syphilis. Again, the history of a foreign body impacted for some time, and any difficulty connected with its extraction, will leave little doubt as to traumatic origin. Strictures due to other simple causes will not be so easy to determine. Previous moderate attacks of hæmorrhage might correctly indicate simple ulcer. Debove's<sup>1</sup> case already quoted is an illustration of this. The rarer causes which have been given, such as chronic œsophagitis, tuberculosis, &c., can, as a rule, only be matter of conjecture.

The value of knowing the cause of the stricture rests upon the light that is thrown upon its nature. Thus the stricture which results from swallowing some caustic fluid will be probably irregular, possibly multiple, and located usually either in the region of the cricoid cartilage, opposite the bifurcation of the trachea, or near the cardia. Strictures, on the other hand, which result from an impacted foreign body, a simple ulcer, or syphilis, will be single, possibly involving only a part of the circumference of the canal, and consist in longitudinal, oblique, or transverse fibrous bands. When a sound can be passed, some of the opinions formed from a knowledge of the cause may be corroborated or possibly extended. Thus, by using a sound with an olive-shaped ivory or metal end, the 'olive' will detect, both in its progress inwards and in its withdrawal, whether there is more than one stricture, the probable length of a stricture, and its

<sup>1</sup> See above, page 48.

calibre and tightness. In a case reported by H. L. Browne,<sup>1</sup> the author by this method of examination was enabled to detect five distinct strictures. Where there is reason to suspect a bridle stricture, hemispherical-headed sounds have been used to discover on which aspect of the wall the stricture is situated. By rotation of the head it is felt on which side the 'hitch' takes place.

**Prognosis.**—The final termination of any case will depend largely upon the cause which has led to the stenosis. It has already been shown that the nature of the stricture varies considerably with the cause. The worst form is that which follows upon the imbibition of some caustic fluid; and it may be said that the sooner the symptoms of obstruction arise after the subsidence of those which follow the immediate injury, the worse is likely to be the stricture. In this class of cases almost the only hope of a successful issue rests in the possibility of dilating the stricture simply, or by some operative means, and keeping it dilated; otherwise death by gradual starvation must be expected. Such cicatricial strictures as arise from ulcers resulting from an impacted body, syphilis, tuberculosis, &c. are mostly dealt with successfully.

The want of accurate knowledge regarding the nature of a stricture in all its aspects must always render any positive prognosis very difficult, if not impossible. Thus it is always possible that cicatrisation may not be circular, only 'island-like'—to borrow an expression of Weinlechner's. In such a case the canal will contract to a certain extent and remain so, the patient being able to swallow fluids but incapable of taking solids. Of such a nature appears to have been the case recorded by Harvey.<sup>2</sup> A man aged 46 years stated that when 5 years old he had swallowed some strong sulphuric acid. For forty years his throat had been almost closed, and he had lived on milk, beef tea, eggs, and cornflour.

Prognosis in regard to treatment even in its simplest form, such as consists in the passage of a bougie, must be somewhat guarded. Weinlechner<sup>3</sup> gives seven cases where after attempts to pass a bougie a rapidly fatal result ensued. The post

<sup>1</sup> *Birmingham Medical Review*, 1890, vol. xxvii. p. 89.

<sup>2</sup> *Ibid.* 1889, vol. xxvi. p. 225.

<sup>3</sup> *Wiener Med. Wochenschrift*, 1880, p. 113.



mortem revealed no gross lesion. In three cases death resulted from pyo-pneumothorax, and in four from empyema. Billroth, in commenting on these cases, believes that septic matter was carried at some time by the bougie through the wall of the œsophagus into its surrounding cellular tissue, and there soon gave rise to an acute inflammation. What success, on the other hand, may follow this mode of treatment is instanced by the same author in a case which he recalls where, ten years after passing the bougie, there was not the least difficulty in swallowing. The apparently simple operation of internal œsophagotomy is not free from untoward results. Thus Sands<sup>1</sup> mentions several cases where accidents have happened. In two cases peritonitis was set up, the result possibly of direct injury to the stomach; in two others hæmorrhage, and in one empyema.

The risks in connection with such major operations as gastrostomy need not be further considered. Little danger appears to be connected with treatment by electrolysis.

---

## CHAPTER X

### CICATRICIAL STRICTURE (*continued*). TREATMENT

By no other measures than those which may be said to be strictly surgical can we treat cicatricial stricture of the œsophagus. Iodide of potassium given internally will aid in syphilitic cases, but with this exception all methods of treatment are based on some kind of mechanical procedure.

The means at our disposal are—(1) Gradual dilatation, (2) forcible or rapid dilatation, (3) electrolysis, (4) internal œsophagotomy, (5) external œsophagotomy, (6) œsophagostomy, (7) gastrostomy.

(1) **Gradual Dilatation.**—This method may be performed in one of two ways, either (A) from above through the mouth, or (B) from below through an opening in the stomach.

(A) *Through the mouth.*—Whatever may be the cause of

<sup>1</sup> *New York Med. Journ.* 1884, vol. xxxix. p. 533.

a stricture, and whatever its form, no case will escape a preliminary endeavour being made to treat it by this method. It is usually owing to some failure in attempts made to dilate in this way that one of the other methods is resorted to.

As in cases of urethral stricture, it is wise to commence with a large-sized bougie, not so much with the object of passing it, but in order to ascertain the exact seat of obstruction. This knowledge gained, a medium-sized instrument may then be tried. If with the most careful pressure it does not enter, an instrument of some two or three sizes smaller should be used. Once the stricture is penetrated, it is well, if the patient can bear it, to retain the bougie within the constriction for some minutes, or indeed as long as can be endured. Considerable difference of opinion exists with regard to the subsequent treatment of the case: whether a bougie should be passed daily or at greater intervals; whether a few days should be spent in passing the same instrument, or whether a larger size should be attempted on each occasion. Rather than lay down any definite rule, it would be wiser to be guided by the nature and behaviour of the case itself. If a stricture is very tight, and the parts are very sensitive to the passage of a bougie, the progress of the treatment should be slow; and, *vice versa*, the more tolerant the parts and the less resistant the stricture, the more frequent may be the passage of the instrument, and the larger its size at each introduction. In a case of gradual dilatation recorded by K. Franks,<sup>1</sup> bougies were passed almost without intermission every second day for seven months, and retained in for periods varying from ten minutes to three hours. This patient, when last seen, had been quite well for six years. Bougies were passed about twice annually.

The retention of a bougie in a stricture tends to dilate it, just in the same way as the retention of a catheter in a urethral stricture. Hence a good plan is to pass a tube as soon as possible, retain it, and feed the patient through it. A short permanent tube has been employed with success. Symonds<sup>2</sup> mentions in his paper, already referred to, that when in Berlin, he saw a case of Renvers's being treated

<sup>1</sup> *Transactions of the Royal Academy of Medicine in Ireland*, 1890, vol. viii. p. 213.

<sup>2</sup> *Lancet*, 1889, vol. i. p. 672.

successfully by the specially devised short hard rubber permanent tube of that surgeon.

Eve<sup>1</sup> reported a case to the Clinical Society of London where he succeeded in first introducing a No. 7 Symonds's tube and subsequently a No. 11. In attempting to withdraw the latter, the string to which it was attached broke. An œsophagostomy was performed for its extraction.

No case should be deemed intractable to this the simplest method of treatment, until several endeavours have been made at variable intervals of time. After the first failure, the patient should be kept in bed and the most careful attention devoted to the diet; and if the condition of the patient will admit, the parts should be kept at complete rest, by the administration of all food *per rectum*. By such means any co-existent spasm may be relieved, and the stricture thereby conquered. (For directions regarding the passing of bougies, see Operations on the (Esophagus, Chapter XVI.)

(B) *Through the stomach*.—This mode of treatment may be adopted in those cases of irregular and multiple stricture, the result of imbibing some caustic fluid, where the patient can swallow liquids, but no bougie can be passed from above. Gastrostomy is first performed, and after the establishment of a gastric fistula, the patient is made to swallow a shot to which is attached a silk thread. This can be brought out by the gastric opening, and by its means tubes or bougies introduced and gradual dilatation effected. A case is recorded by Tietze<sup>2</sup> of a boy aged 16, in whom, twelve days after gastrostomy, a thread was passed with a sound through the whole length of the œsophagus, one end coming out through the nose, and the other through the gastric fistula. A drainage tube was eventually passed through the stricture and left. Dilatation was effected, and eventually the gastric fistula was allowed to close. This author records two other cases where it was found impossible after gastrostomy to effect any passage of the stricture. In both instances œsophagotomy was performed in addition. It was then found possible to pass bougies from the œsophageal opening, and thus gradually

<sup>1</sup> *Brit. Med. Journ.* 1892, vol. ii. p. 894.

<sup>2</sup> *Ibid.* Epitome, 1894, vol. i. p. 82.

dilate the stricture. Tietze prefers gradual dilatation with a drainage tube to bougies.

Terrillon<sup>1</sup> records a case in which he succeeded by this method; gastrotomy, however, and not gastrostomy, was performed, the opening into the stomach being closed after the first bougie was made to pass from above downwards through the stricture. Dixon<sup>2</sup> succeeded by gradual dilatation after gastrostomy.

(2) **Forcible or Rapid Dilatation.**—This method may also be performed either (A) from above through the mouth, or (B) from below through an opening in the stomach.

(A) *Through the mouth.*—There are various methods by which this may be performed.

(a) *With ordinary bougies.*—In adopting these means, the same procedure is made use of as in the rapid dilatation of an urethral stricture. One bougie is made to follow the other until the stricture has been forcibly stretched or burst to the required extent.

CASE XXXVII.—*Forcible dilatation of cicatricial stricture with bougies.*

A boy aged 12 years had three strictures in the œsophagus, the tightest being near the cricoid cartilage, caused by swallowing liquor potassæ. Dilatation was effected gradually until a No. 11 urethral catheter-sized bougie was passed, but no further dilatation could be effected. A special bougie was devised by which more force could be used, but with equal safety. The instrument consisted in a whalebone bougie, which was first introduced, and then this served as a guide for the gliding along of the specially devised 'olive-ended sounds.' By this means a sound of a diameter of three-quarters of an inch was forced through the stricture. A few drops of blood were coughed up and a little pain complained of, but otherwise no ill effects were experienced. When seen eighteen months later the boy could swallow perfectly. (MacCormac, 'Lancet,' 1886, vol. i. p. 191. The instrument devised and used by this surgeon is shown by a drawing.)

(b) *With railway catheters.*—A tube with terminal openings is passed through the stricture. Through this tube is inserted a catgut bougie. The tube is then removed, and the bougie used as a guide for the passage of catheters of increasing calibre. James Berry<sup>3</sup> has successfully adopted this method

<sup>1</sup> *Journal of Laryngology and Rhinology*, 1890, vol. iv. p. 159.

<sup>2</sup> *Annual of the Universal Medical Sciences*, 1892, vol. iv. F—36.

<sup>3</sup> *St. Bartholomew's Hospital Reports*, 1884, vol. xx. p. 45.

in two cases. He found also that the catgut guide enabled him to pass a soft rubber tube.

(c) *With sea tangle, tupelo-wood dilators, or laminaria tents.*—This appears a useful way of dilating when the passage of bougies causes much pain or bleeding. The use of sea tangle was successfully adopted by Whitla<sup>1</sup> in a case of stricture resulting from swallowing sulphuric acid. Senator,<sup>2</sup> of Berlin, as already indicated above, has used laminaria tents in the treatment of malignant stricture.

(d) *With specially devised instruments.*—Of all the rapid methods of dilatation, that effected by an instrument inserted within the stricture and then expanded is the most forcible and severest. The treatment resembles that of dilatation of an urethral stricture with a Holt's dilator. Kendal Franks<sup>3</sup> has recorded a case of stricture due to injury from a foreign body, where, by means of Otis's dilating urethrotome without the blade, he was able to dilate the stricture to the full size of the instrument. Ordinary bougies were passed for some time afterwards, and the patient did well, having only a few slight returns of recontraction after the lapse of eight years.

(B) *Through the stomach.*—The cases which will fall to be treated by this method will be those where it is found impossible to penetrate the stricture from above. A gastrotomy is first performed, and the orifice of the œsophagus sought for with the forefinger. A dilator is then passed into the œsophagus through the guidance of the finger, and gently pressed upwards through the stricture. When well within the constricted portion it is opened to its full extent and moved up and down three or four times before withdrawing. The stomach is then closed, and lastly the abdominal parietes. Loreta,<sup>4</sup> who has performed this operation three times successfully, states that he opens the dilator to the extent of five centimeters. In his first case the patient swallowed a good meal six hours after the operation.

(3) **Electrolysis.**—This mode of treatment has developed considerably within recent years, and, to judge by the large

<sup>1</sup> *Dublin Journal of the Medical Sciences*, 1879, 3rd series, vol. lxxviii. p. 175.

<sup>2</sup> *Brit. Med. Journ.* 1889, vol. i. p. 1417.

<sup>3</sup> *Medical Press and Circular*, 1882, vol. i. p. 335.

<sup>4</sup> *Brit. Med. Journ.* 1885, vol. i. p. 374.

number of cases now recorded, would appear to be both successful and free from danger. Fort<sup>1</sup> is reported as having cured seven out of nine cases in a period of from nine to thirty days. In one case,<sup>2</sup> where the stricture was situated two inches above the cardia, four sittings overcame the obstruction. Painter<sup>3</sup> records the case of a woman who had a band of constriction about sixteen inches from the incisors. After fifteen applications—three being applied weekly—meat and bread could be swallowed; and after twenty-five applications, lasting three months, the patient could eat without regurgitation so long as the meat was cut up finely. Two cases are reported by Kendal Franks.<sup>4</sup> In one the result is noted four years after the treatment, when no sign of recontraction could be detected. The other, a recent case, had so far proved successful.

The advantages of this method of treatment would appear to be in the greater rapidity with which, as a rule, dilatation is effected as compared with the results of gradual distension by bougies; and a less tendency to recontraction. The treatment is, however, usually combined with the passage of bougies.

This method cannot be used when the stricture is impermeable to any instrument. (For directions regarding the practical application of electrolysis see Chapter XVI.)

(4) **Internal œsophagotomy.**—This may be performed in one of two ways. Either (A) from above through the mouth, or through an opening in the œsophagus (external œsophagotomy); or (B) from below through the stomach.

(A) *Through the mouth.*—This is the usual way, and is performed only on such strictures as are not too tight to prevent the introduction of the œsophagotome. It is not a method of treatment in much favour with English surgeons, but has been practised more frequently in France, where it was originally introduced. So many disasters have resulted from the cutting of strictures that the method has not attained to any favour. As already indicated,<sup>5</sup> pleurisy, empyema,

<sup>1</sup> *Journal of Laryngology and Rhinology*, 1890, vol. iv. p. 119.

<sup>2</sup> *Ibid.* 1889, vol. iii. p. 249.

<sup>3</sup> *Ibid.* 1888, vol. ii. p. 418.

<sup>4</sup> *Transactions of the Royal Academy of Medicine in Ireland*, 1890, vol. viii. p. 216.

<sup>5</sup> See above, Sands, page 93.

pneumonia, and other inflammatory mischief have followed the operation. The cases most suited for this treatment are those where the obstruction is due to a localised fibrous band. The œsophagotome is passed beyond the constriction, then expanded and withdrawn, so dividing the stricture in its passage outwards. Mackenzie<sup>1</sup> performed the operation in one case, and although the patient survived the treatment three months, it appears not improbable that death was in some way connected with the pneumonia and pleurisy which developed a few hours after the operation. Roe,<sup>2</sup> using Mackenzie's œsophagotome, succeeded in dividing without subsequent complication two cases of stricture. In one the stricture was divided in three different places; in the other in six. In both, subsequent dilatation was effected with bougies. The paper by this author may be consulted with advantage on the merits of the operation. He is an advocate of it himself, and quotes thirteen cases besides his own two, to show that out of a total of fifteen only two deaths occurred as a direct result of the treatment.

For the operation when performed through an opening in the neck, see under External Œsophagotomy.

(B) *Through the stomach.*—The same reason applies for opening the stomach to perform internal œsophagotomy as in the case of the passage of bougies—that is to say, the stricture is impassable from above through the mouth. Lange<sup>3</sup> reports the case of a girl 4 years old, who, when 2 years of age, swallowed a quantity of concentrated lye. The stricture was impassable from above, but after gastrotomy and several subsequent endeavours a small whalebone bougie was got through the stricture from above and pulled outwards. A thread was then attached to the lower end, and a series of small blades forcibly drawn through the strictured portion.

To avoid the dangers of sepsis instanced above, Meyer has proposed a method of disinfecting the œsophagus by the preliminary combined performance of gastrotomy and external œsophagotomy. (See below.)

(5) **External œsophagotomy.**—This operation implies either

<sup>1</sup> *Diseases of the Throat and Nose*, vol. ii. p. 138.

<sup>2</sup> *New York Medical Record*, 1882, vol. xxii. p. 536.

<sup>3</sup> *New York Med. Journ.* 1890, vol. li. p. 131.

a division of the stricture from without, as in the somewhat similar operation of external urethrotomy, or the temporary opening of the œsophagus above the stricture for the purpose of facilitating the passage of bougies or œsophagotomes. The former of these uses of the operation has but rarely been practised. Dechambre's<sup>1</sup> cases, which are quoted by some authors, appear to have reference solely to malignant strictures, although on one occasion at least the operation was done in the belief that the stenosis was due to syphilis. In nearly every case the result was unsatisfactory. In the case already referred to by Eve,<sup>2</sup> where an external œsophagotomy was performed for the extraction of a Symonds's tube, the opportunity was taken to divide the stricture also. The œsophagus was somewhat forcibly drawn up with forceps and the cicatricial stricture successfully divided with scissors. When seen two years afterwards the patient had no difficulty in swallowing, and a No. 18 bougie passed easily. The second use of the operation, to facilitate the passage of bougies, has been much more frequent. It has been found that when failure has attended any endeavour to introduce a bougie by way of the mouth, the stricture has been overcome by introducing it through an external opening in the neck. The reason for this is that the course is more direct, the bougie not having to follow the curve from the mouth. Another advantage also exists in the possibility of retaining the bougie for a longer time within the stricture, such retention considerably facilitating the subsequent and easy passage of larger sizes. This mode of treatment finds a strong advocate in Heineke,<sup>3</sup> of Erlangen.

In conjunction with either gastrostomy or gastrotomy it has comparatively recently been successfully adopted by Abbe.<sup>4</sup> (See also Tietze, page 95.) A very fine conical gum-elastic bougie was passed upwards through the stricture. To its end was attached a piece of heavy braided silk. After being drawn through, it was pulled backwards and forwards in see-saw manner, and in so doing the stricture was rapidly divided. Four months after the operation the patient was exhibited before the New York Surgical Society. Solid food, as well as

<sup>1</sup> *Dictionnaire des Sciences Médicales*, 2<sup>e</sup> série, tome xiv. p. 478.

<sup>2</sup> See page 95.

<sup>3</sup> *Annals of Surgery*, 1890, vol. xii. p. 360.

<sup>4</sup> *Ibid.* 1893, vol. xvii. p. 489.



liquid, was swallowed without difficulty, and the patient continued to pass a bougie every other day, to avoid the possibility of recontraction taking place. Still later,<sup>1</sup> when Abbe was exhibiting a second case upon whom he had successfully performed the same operation, he reported that his first patient continued in perfect health. Kendal Franks<sup>2</sup> read a paper before the Royal Academy of Medicine in Ireland on this same method of treatment, and showed a patient upon whom he had successfully performed the operation. He appends a table of twenty cases treated by gastrotomy and retrograde dilatation, to which Woolsey<sup>3</sup> subsequently added eight more.<sup>4</sup> Murray<sup>5</sup> showed at the New York Surgical Society on October 10, 1894, a child 2 years old successfully treated by Abbe's method. The first endeavour failed; but after a delay of nine days, the stomach having been stitched to the parietes, a fine bougie with silk attached was passed, and the stricture sawn through. The œsophagus was not opened. At the same meeting Abbe referred to his two cases above quoted, which he stated to be perfectly well, and 'eating everything.' W. J. Mayo,<sup>6</sup> in a child 3 years old, first performed gastrotomy and one month later œsophagotomy. Success then followed Abbe's string method.

Eklund<sup>7</sup> has made use of an external œsophagotomy for the internal division of a stricture. He succeeded in introducing through the opening Maisonneuve's urethrotome and divided the stricture. In order to combat the septic after effects of internal œsophagotomy Meyer<sup>8</sup> has made the following suggestion. Gastrotomy and external œsophagotomy are first performed. 'Before starting the internal incision, irrigate the œsophagus from the fistula in the neck downward with Thiersch's solution or a solution of permanganate of potassium, allowing the water to pass out of the gastric opening and during a sufficiently long time, to be sure that this portion of the canal

<sup>1</sup> *Annals of Surgery*, 1894, vol. xix. p. 88.

<sup>2</sup> *Ibid.* p. 385.

<sup>3</sup> *Ibid.* 1895, vol. xxi. p. 253.

<sup>4</sup> It should be noted that in seventeen out of these combined twenty-eight cases gastrotomy, and not gastrostomy, was performed.

<sup>5</sup> *Annals of Surgery*, 1894, vol. xx. p. 733.

<sup>6</sup> *New York Med. Journ.* 1894, vol. lix. p. 433.

<sup>7</sup> *Annual of the Universal Medical Sciences*, 1890, vol. iv. F—32.

<sup>8</sup> *New York Med. Journ.* 1892, vol. ii. p. 561.

is thoroughly disinfected. Also carefully wash the stomach from below. (This preparatory treatment may be repeated during a number of days.) Push an iodoformed sponge, or a pad of iodoform gauze on a thread, into the upper portion of the œsophagus, between the opening in the neck and pharynx, so as to guard against the descent of the secretions of the mouth. Then do internal œsophagotomy under constant irrigation from the wound in the neck downwards. Continue the same after the operation is finished. The water will run into the stomach and readily escape through the gastric fistula. Finally pull an iodoformed sponge, or ball of iodoform gauze, with the help of a bougie and thread, through the gastric opening and the cardia into the lower end of the œsophagus. This will prevent regurgitation of the contents of the stomach in the subsequent direct feeding through the abdominal opening.'

(6) **Œsophagostomy.**—This operation is only possible when the stricture is situated sufficiently high in the neck to admit of the opening into the gullet being made below it. The object of the operation is twofold. In the first place it admits of the patient being fed, and in the second it gives access to the stricture above for any treatment that may be attempted. It is of course limited to such cases as are impassable.

(7) **Gastrostomy.**—This operation, essentially for the purpose of feeding a patient, is usually adopted only in extreme instances. The patient is generally much run down, and the stricture one which cannot be passed. Under these circumstances the only hope rests in opening the stomach and creating an orifice for the introduction of food. Such a measure as this is of course only palliative, but the rest given to the strictured part of the gullet may admit subsequently of dilatation being effected, as shown in the case below. It has been shown above, however, that gastrostomy may be performed directly with the object of treating the stricture: that through the temporary gastric orifice, bougies or œsophagotomes can be introduced. To what extent life may be prolonged by this operation, with complete failure to dilate the stricture, is shown by a case operated upon by Trendelenburg.<sup>1</sup> The patient was a boy who was compelled to feed himself entirely through the

<sup>1</sup> MacCormac, *Lancet*, 1886, vol. i. p. 192.

artificial opening, the food being first masticated in the mouth and then spat down a tube into the stomach. The boy was alive and well years afterwards.

CASE XXXVIII.—*Cicatricial stricture of œsophagus treated by gastrostomy, and subsequent dilatation with bougies.*

‘The patient, a girl, was admitted into the Victoria Hospital for Children in July 1889. Seven weeks previously she had swallowed some caustic soda. At the time of her admission she was unable to swallow anything at all. During August she was fed entirely by nutrient enemata and no bougies were passed, so as to give absolute rest to the œsophagus. In September, although she had materially improved in general condition, no instrument could be passed through the stricture. On September 13 the œsophagus was opened in the neck with the hope of being able to reach the stricture. The obstruction, however, was found to be within the thorax. After these wounds were closed with suturing, the first stage of gastrostomy was performed by means of hare-lip pins. Five days after, the stomach was opened and the child fed through the gastric fistula. On January 27, 1890, a very small whalebone bougie was at last passed through the stricture, and after many months of varying success a No. 14 œsophageal bougie was eventually passed with ease. During 1891 this large bougie was passed about once a month, and the plug removed from the gastric opening. Attempts were subsequently made to close this opening by passing the actual cautery along the sinus, and it was now absolutely closed. She was in perfect health, and came to the hospital once in six weeks to have the bougie (No. 14) passed. No contraction could be felt.’ (Clutton, ‘Trans. Clin. Soc. Lond.’ 1892, vol. xxv. p. 253.)

---

## CHAPTER XI

### PARALYSIS AND SPASM

**Paralysis.**—Cases of this kind are rare, and are not likely in the first instance to come under the surgeon’s observation. The affection is not infrequently associated with some other neuropathic symptoms, and for this reason the cases are regarded as medical rather than surgical. It is only when the symptom of dysphagia predominates and other manifestations are but slightly observable that the surgeon may be called upon to make a differential diagnosis.

**Etiology.**—The motor and sensory supply of the œsophagus being through the vagi, and the latter taking their origin from

the medulla, any paralysis of the gullet must be effected in one of three ways. Either the origin or roots of the nerves must be involved; or the trunks implicated, somewhere between the medulla and the canal; or the muscular wall or mucous membrane so affected that it will either not receive or not transmit impulses.

Considering first such causes as may affect the roots of the nerves, any lesion in the pons or medulla may cause paralysis, or even pressure communicated from some more distant part. The commonest of these lesions is that due to chronic inflammation such as is met with in glosso-labio-laryngeal palsy and more rarely in the course of lateral sclerosis or locomotor ataxia.

Another lesion is hæmorrhage. Wepfer, as quoted by Mondière,<sup>1</sup> has recorded a case of death from this cause. Tumour occurring also in these same regions will give rise to similar results. Montaut, also quoted by Mondière, presented to the Académie de Médecine a specimen of an hydatid cyst which had developed at the base of the brain and by pressure on the medulla caused paralysis.

Implication of the vagi in their course from the brain to the gullet may be reckoned as the rarest of the causes which lead to paralysis. Mondière's exhaustive paper must be again referred to for cases illustrative of this cause. Thus Koehler saw a case where the nerves were pressed upon by a tuberculous mass, presumably of lymphatic glands; and Wilson a similar instance, only due to a syphilitic affection of the cervical vertebræ.

Affection of either the muscular tissue or mucous membrane of the œsophagus is said to afford instances of this condition. It is difficult, however, to say whether it is these tissues which are at fault, or whether it is the result of certain specific influences acting directly upon them or indirectly, through the effect of these influences upon the nervous system. The diseases here implied are those which may be termed general or constitutional; such, for instance, as partial or complete paralysis occurring in the course of diphtheria, lead poisoning, syphilis, and some of the acute fevers.

<sup>1</sup> *Archives Générales de Médecine*, 2<sup>e</sup> série, tome iii. p. 44.

**Symptoms.**—The only symptom indicative of this affection is difficulty in swallowing, depending in its severity upon the degree of paralysis. Food is taken and not as a rule regurgitated, but the patient is conscious of its non-passage into the stomach from a feeling of discomfort somewhere in the course of the canal.

**Diagnosis.**—Little difficulty will be found in distinguishing the dysphagia of paralysis from that due to organic obstruction. In the first place the history of the case and the presence of other symptoms will of themselves frequently be sufficient to indicate the true cause of the trouble. But should any doubt still exist, it will be readily cleared up by the passage of a bougie, which will be found to pass without material obstruction. Auscultation will reveal also an absence of the normal œsophageal sound.

**Prognosis.**—The prospect of recovery depends upon the nature of the cause, of which the dysphagia may be but one of the symptoms. Where the lesion is in the brain and in some part involving the nerves, little hope can be entertained of recovery. Where, on the other hand, the dysphagia is dependent upon some weakness in the muscular tissue, or connected with diphtheria or lead poisoning, a good result may be looked for.

**Treatment.**—In cases where the dysphagia exists only as a symptom, all curative treatment must be directed to the complaint to which it owes its origin. These cases, however, being frequently the most hopeless, palliative measures must be adopted, and the difficulty in swallowing overcome by the passage of a tube for feeding purposes. The patient's strength should be kept up by the administration of tonics. Iron, arsenic, or strychnine should be given, and the food should be of a nourishing and stimulating character. In order to give some tone to the muscular coat, electricity may be applied. The negative electrode should be introduced within the canal, while the positive is placed against the skin of the spine posteriorly. According to instructions given by Morell Mackenzie, who states that he has successfully adopted this method in numerous cases annually, the treatment should be carried out daily, if not more frequently, each application lasting a few seconds, and the time for its use being preferably

before meals. The treatment usually needs to be carried out for some weeks.

**Spasm.**—In contrast with the relaxation of the muscular coat of the œsophagus, as in the condition of paralysis just described, we have in spasm of the canal—or œsophagismus, as it is sometimes called—an abnormal contraction of this coat, whereby a narrowing of the canal is produced, and, as a consequence, difficulty in deglutition. More or less spasm always accompanies the impaction of a foreign body, but such contraction is due to local irritation produced by the body itself, and is therefore not included in the present class of cases.

**Etiology.**—In a large proportion of the cases the condition is associated with a highly nervous temperament. This appears in many cases to be the only explanation. More commonly, however, some localised exciting cause exists, and this, acting upon an unstable nervous system, produces the condition.

It is difficult, in some of the causes enumerated below, to trace the connection between the exciting lesion and the apparently reflex spasm. But when it is remembered how numerous are the connections of the vagi—the motor and sensory nerves of the gullet—with the various tissues and organs of the body, it will at least be gathered how many are likely to be the lesions which may serve as incentives to an attack of spasm, especially in a predisposed individual.

Although the affection must be distinctly classified as a rare one, many cases have been recorded; and as regards the numerous causes, it is striking how few cases there are which can be found to so closely resemble each other, that any one particular lesion can be singled out as specially frequent or common.

Among the various causes, then, which may be mentioned as in some way, either reflexly, directly, or otherwise, giving rise to spasm, is profound emotion, as from fear, passion, or great excitement of any kind. Habershon<sup>1</sup> mentions fright produced by a thunderstorm. Hereditary proclivities have been traced in some instances. Imagination is a known cause, as in the belief of a foreign body in the gullet, or as the result of

<sup>1</sup> *Diseases of the Abdomen*, 2nd ed. p. 19.

being bitten by a dog, the mimicry being that of hydrophobia. To hydrophobia, as is well known, spasm is incidental.

Carcinoma of the liver affords some striking illustrations. Mayo Collier<sup>1</sup> related a case, at a meeting of the British Laryngological and Rhinological Association, where the patient had suffered for three months from difficulty of swallowing. Death resulted from a large cancer of the liver. No disease existed in the œsophagus or elsewhere. This author had looked over the record of cases of cancer of the liver, and in four of them it was noted that the disease was associated with reflex stricture of the œsophagus. Treves informed this author also that three cases which had been handed over to him for operation proved not to be stricture, but cases of cancer of the liver. Affections of the stomach and intestines—intestinal worms; gout, especially as pointed out by Brinton<sup>2</sup> when dyspepsia is a prominent symptom; repeated vomiting; pregnancy and diseases of the uterus—leucorrhœa, menorrhagia, and dysmenorrhœa; various affections of the ear, teeth, tonsils, nose, nasopharynx, and larynx, as shown by Joal<sup>3</sup> (this author relates observations of nine patients who were cured by treatment of intranasal conditions); chorea and epilepsy; in all these conditions it may be met with. Lastly, and possibly the most frequent of all causes, are hysteria and hypochondriasis. Instances of many of these causes will be found in an exhaustive paper on the subject by Eloy.<sup>4</sup>

Reference should be made here to what Paget<sup>5</sup> has termed ‘stammering with the œsophagus.’ While allied to spasm, Paget is inclined to consider it a different affection. The symptoms resemble very closely those described by the same author as characteristic of ‘urinary stammering.’ ‘Sometimes swallowing is easy and unhindered; at others very difficult, especially in company, or when the trouble is particularly inconvenient, or the mind too much set on it.’

**Symptoms.**—The dysphagia characteristic of spasm is usually sudden in its onset. The patient may be in the

<sup>1</sup> *Journal of Laryngology*, 1894, vol. viii. p. 94.

<sup>2</sup> *Lancet*, 1866, vol. i. p. 3.

<sup>3</sup> *Journal of Laryngology and Rhinology*, 1889, vol. iii. p. 417.

<sup>4</sup> *Gazette Hebdom. de Méd. et de Chir.* 1880, 2<sup>e</sup> série, tome xvii. p. 741.

<sup>5</sup> *Clinical Lectures and Essays*, 1875, p. 82.

middle of a meal when he suddenly finds difficulty in swallowing a bolus of food or a mouthful of fluid. Occasionally it is at once regurgitated, and sometimes so violently as to be ejected through the nostrils. At other times a sensation of obstruction is felt which only lasts for a short time, when it passes off and the material is felt to pass on into the stomach. Regurgitation is more frequent when the spasm attacks the upper part of the gullet, and in these cases the food is ejected immediately after being taken. The spasmodic attacks vary in frequency and severity, and may extend over long periods. Although the affection is mostly intermittent, cases occasionally reach a stage in which there appears to be no relaxation of the spasm.

Intolerance of food is sometimes absolute, and an actual distaste for it exists in many cases associated with dyspepsia. In other cases, again, there is a variation in the choice of aliments, their temperature, consistence, and nature being matters of consideration. As a rule warm foods are tolerated better than cold; and not infrequently solids can be taken better than fluids. The sensations experienced by the patient vary. When the spasm attacks the upper part, the patient often imagines that a foreign body of some kind is in his throat. Spasm in this region also is often associated with spasmodic contraction of the muscles of the neck, and of the larynx and pharynx, so that troubles in connection with the voice and respiration are complained of, amounting sometimes to feelings of strangulation and suffocation. Pain, when it exists, varies in its intensity, duration, and seat. It is not usually of any diagnostic value, but interscapular pain occurs when the spasm is in the upper part of the œsophagus. Hiccough is sometimes present. Emaciation, when it exists, indicates usually either that the affection has lasted for a long time, or that it is associated with gastric disturbances.

Along with the dysphagia there are usually other symptoms of the disease or functional disturbance upon which it depends. Thus in the case of gout it will probably be 'attended with great acidity and loading of the urine with uric acid and urates, and is often connected with tympanitic distension of the stomach and intestines' (Brinton).<sup>1</sup> In

<sup>1</sup> *Lancet*, 1866, vol. i. p. 3.



cases of hysteria or hypochondriasis, something in the history of the past habits of the patients, or possibly in their present condition, will suggest the neurotic origin of the complaint.

Osgood<sup>1</sup> quotes some cases illustrative of what he terms 'a peculiar form of œsophagismus.' In these cases the attacks of spasm were not limited to meal times; and when occurring at that time, there was only slight regurgitation. The food would be temporarily arrested, and then pass on into the stomach. In some of the cases the attacks occurred often throughout a period of some years, each attack lasting only a few moments. The chief symptom was a 'localised distress, a sense of clutch, weight, or compression.' Pain, often intense, was felt at the spot where the patient was conscious of the sense of constriction. From here it radiated to other parts, and in some cases was felt in one or both ears. A bougie passed with ease. No special condition of the patient seemed to suggest a cause, nor was there any local lesion to which a reflex influence could be attributed. The best treatment was found to be the application of galvanism to the epigastrium and the administration of effervescent drinks, the eructations which followed relieving the sense of constriction.

**Diagnosis.**—The disease with which spasm of the œsophagus is most likely to be mistaken is carcinoma, and the fact that spasm is sometimes associated with malignant disease renders the diagnosis not always devoid of difficulty. Lacombe's<sup>2</sup> cases have already been referred to. In one of these, carcinoma of the œsophagus existed at one part of the gullet, while spasmodic contraction existed at another; and in the second case, spasm was associated with carcinoma of the stomach. But a certain amount of spasm often exists at the seat of the disease itself, and, as already shown,<sup>3</sup> its sudden appearance in such cases has often proved to be the first symptom of the disease. Excluding, however, these instances, there are certain distinctive features of the affection which should render differentiation comparatively easy. The age, sex, and general condition of the patients are often sufficient

<sup>1</sup> *Boston Med. and Surg. Journ.* 1889, vol. cxx. p. 401.

<sup>2</sup> See page 67.

<sup>3</sup> See page 65.

of themselves to enable a diagnosis to be made. Thus in cases of spasm the patients are frequently young women or girls, and often in good physical condition. The dysphagia is of sudden onset and generally intermittent; and when such distinctive symptoms exist as a distaste for food, or a better passage of solids than of liquids, or greater ease in swallowing warm than cold aliments, or immediate regurgitation after deglutition—the opposite of any of which conditions is the rule in carcinoma—little doubt will exist as to the true nature of the obstruction. The diagnosis will be verified by the passage of a bougie and by auscultation. The passage of a bougie will in some cases at once settle the question of mere spasm by the ease with which it passes into the stomach. In other cases, however, the contact of the bougie at once increases the spasm, but with gentle and persistent pressure relaxation may follow, and the bougie pass on. Occasionally, though rarely, the spasm is too great to be overcome. In such cases it is wise to desist for a time, and try again after the adoption of some calmative therapeutic measures. Auscultation reveals an absence of the normal œsophageal sound. The arrest of the morsel will be indicated by an arrest of the sound, followed often, however, by another sound of ‘bubbles of gas bursting in a liquid.’ At times an intermittency in the progress of the bolus may be made out.

**Prognosis.**—Speaking generally, spasm of the œsophagus is a curable affection. It has, in a few very exceptional instances, led to a fatal result. Depending as it does upon so many causes, its duration and severity are solely affected by the disease to which it owes its origin. Hence, when due to a neurotic or functional disturbance, a more rapid and lasting cure may be expected than in cases where there is some chronic local disease reflexly producing the spasm, or some more general affection, such as gout. But in every case the relief of the exciting cause may be suspected to be rapidly followed by a subsidence of difficulty in deglutition.

**Treatment.**—As a rule, patients suffering from œsophageal spasm will need to be treated for the condition itself, as well as for the cause upon which it may depend. As regards the local treatment, the simple passage of a bougie may be

sufficient to cure the spasm. In cases where the mucous membrane appears intolerant of the presence of a bougie, the parts may be rendered less irritable by some topical application. Mackenzie found a weak solution of nitrate of silver (five or ten grains to the ounce) to answer best. The solution is injected by a tube or catheter to as near the contracted part as possible. In some cases subcutaneous injections of morphia have answered; in others the internal administration of bromide of potassium, strychnine, or belladonna. In one case Eloy,<sup>1</sup> failing to pass a bougie, succeeded after giving bromide of potassium for a few days. In another case, the same difficulty was overcome after subcutaneously injecting morphia a few hours previously. The employment of electricity has succeeded when the passage of a bougie has failed. As regards the treatment of the various causes giving rise to spasm, little need be added here. Hysteria, gout, affection of the throat, ear, &c. need each to be dealt with according to the principles governing the ordinary treatment of these diseases. Some judgment will be required in the proper selection of nourishment. Any food liable to excite spasm should be withheld, and it will generally be found that fluids rather than solids will answer best; and warm materials rather than cold. Mackenzie points out that 'in nine cases out of ten if the drink be sweetened it will be borne better.'

CASE XXXIX.—*Spasm of the œsophagus due to gout.*

A gentleman over 60 years of age was suddenly seized with obstruction of the œsophagus, which completely barred the passage of any food, liquid or solid, into the stomach. The patient, who was in excellent health, inadvertently swallowed a piece of meat imperfectly masticated, which did not enter the stomach, but lodged in the gullet near its cardiac extremity. This he recognised by the sense of oppression which immediately ensued in the lower dorsal region. Any attempt to swallow fluid caused hiccough, followed by the ejection of the material. A probang was introduced, but would not pass into the stomach. A large bougie was also tried, but any attempt to swallow fluid after still showed complete obstruction. No further attempts were made, and the patient was enjoined to keep at rest. Thirty minims of laudanum were prescribed. On the following day liquid extract of belladonna was brushed freely over

---

<sup>1</sup> *Gazette Hebdom. de Méd. et de Chir.* 1880, 2<sup>e</sup> série, tome xvii. p. 808.

the spine in the dorsal region, while ten minims of the tincture of the same drug were administered in teaspoonful doses every four hours. This treatment was continued until about eight o'clock in the evening, when, on swallowing several small pieces of ice in rapid succession, it was found that they were no longer rejected, but freely entered the stomach. Shortly after the patient was able to regale himself with half a pint of soup. From this time the dysphagia entirely ceased. The œsophagus was thus occluded for twenty-four hours. The patient had symptoms of gout. (J. Moorhead, 'Lancet,' 1881, vol. ii. p. 164.)

---

## CHAPTER XII

ABNORMALITIES : DILATATION. DIVERTICULA. CONGENITAL  
ATRESIA. CONGENITAL STENOSIS. TORSION

**Dilatation.**—As distinguished from a pouch or diverticulum, dilatation of the œsophagus implies a more or less general expansion of the canal. It may involve the whole gullet between its extreme limits, or only the lower segment. It usually involves uniformly the calibre of the canal, but occasionally, though rarely, there is a greater bulging in one direction. Where the dilatation is general, the widest part is about the middle, so that the canal presents a somewhat fusiform outline. In cases following upon obstruction at the cardia, the widest part is near that region.

**Etiology.**—Numerous causes have been suggested as giving rise to this rare condition. That it occasionally ensues as the result of some form of obstruction is certain. In cases both of carcinoma and cicatricial stricture instances have been recorded, and in one case at least it seems to have resulted from external pressure. In this particular instance, reported by Handford,<sup>1</sup> the patient had an enormously dilated aorta, which caused obstruction by pressing the œsophagus against the unyielding central tendon of the diaphragm. Among other obstructive influences Einhorn<sup>2</sup> has suggested two, spasm of the cardia, and defective reflex relaxation of the same orifice. The former of these cases appears to have

<sup>1</sup> *Trans. Path. Soc. Lond.* 1888, vol. xxxix. p. 103.

<sup>2</sup> *New York Medical Record*, 1888. vol. xxxiv. p. 751.

existed in a case reported by Leichtenstern.<sup>1</sup> A girl, 19 years of age, had had vomiting for seven years, attributed to hysteria. At the post mortem an enormous dilatation of the thoracic portion of the œsophagus was found. The cardiac orifice was spasmodically contracted, and that this was the primary cause was strongly insisted upon by the author. Other cases seem to depend more directly on the condition of the wall of the gullet itself; thus catarrhal affection of the mucous membrane appears to have been a likely incentive in more than one instance, as for example Bristowe's,<sup>2</sup> Luschka's,<sup>3</sup> and Hannay's<sup>4</sup> cases. The explanation given by the last author is, that the inflammation extends into the muscle tissue so as to damage its structure and impair its function, the result being that food accumulates and distension takes place. Among other causes, paralysis and general muscular atrophy have been given. A case recorded by Klebs<sup>5</sup> is said to illustrate the latter. That disease of the vagi should give rise to dilatation has been theoretically suggested by Einhorn, who based his opinion upon the physiological experiment that division of the vagus causes food to lodge in the lower part of the gullet. In four recorded instances by Hannay, Purton,<sup>6</sup> Davy,<sup>7</sup> and Einhorn, the patient's first symptoms of dysphagia dated back to an accident. In the cases of the first two authors it was a severe blow on the sternum, in Davy's after a violent strain, and in Einhorn's after a fall. What connection exists between these alleged causes and the conditions under consideration it is difficult to say. That some cases are congenital is confirmed by the observation of Zenker,<sup>8</sup> who found on examining the body of a seven-months child, which died when 7 days old, a spherical dilatation of the lower end of the œsophagus. The case recorded by Wilks<sup>9</sup> was believed by that author to have such an origin, or

<sup>1</sup> Solis-Cohen, *Annual of the Universal Medical Sciences*, 1892, vol. iv. F 28.

<sup>2</sup> *Brit. Med. Journ.* 1887, vol. ii. p. 885.

<sup>3</sup> Virchow's *Archiv*, Bd. xlii. p. 473.

<sup>4</sup> *Edinburgh Medical and Surgical Journal*, July 1833, p. 68.

<sup>5</sup> Ziemssen's *Cyclopædia of Medicine*, vol. viii. p. 51.

<sup>6</sup> *London Medical and Physical Journal*, vol. xlvi. p. 540.

<sup>7</sup> *Medical Press and Circular*, 1875, vol. i. p. 382.

<sup>8</sup> Ziemssen's *Cyclopædia*, vol. viii. p. 51.

<sup>9</sup> *Trans. Path. Soc. Lond.* 1866, vol. xvii. p. 138.

possibly more correctly the stricture which existed below the dilatation. The enlargement of the canal at such an early period of life has suggested the homology of the first stomach of a ruminant. Knott<sup>1</sup> points out that a distinguishing pathological feature between congenital and acquired dilations is that in the former 'the muscular coats of the œsophagus are found to be hypertrophied,' while in the latter 'the opposite condition of atrophy and attenuation is sometimes met with.' Rolleston<sup>2</sup> reported to the Pathological Society of London the case of a boy aged 8 years who died after six weeks' vomiting. As pointing to a nervous origin, a brother of the boy had died of vomiting after scarlet fever, and an uncle was also said to have died of vomiting. There was hypertrophy of the muscle coat, but no annular hypertrophy at the cardiac orifice.

**Symptoms.**—The dysphagia and regurgitation, which are the prominent symptoms of dilatation, are often of prolonged duration, in some cases dating back to childhood. Although the disease may be congenital, the symptoms do not usually appear till the patient is some years of age. The difficulty in swallowing, at first only slight, gradually increases, and is accompanied by pain which varies in degree and kind. It is usually located at some particular spot, where a sense of obstruction also exists. Relief is often obtained by the adoption of some special attitude; thus Einhorn's patient would walk up and down, making deep inspiratory and expiratory efforts, at the same time pressing forcibly with his hand: by such means he was enabled to get the food into his stomach, and so relieve himself of the pain and inconvenience. Davy's patient 'was obliged to take his meals in a semi-recumbent posture, with his right arm over the back of the chair.' Gradenwitz<sup>3</sup> recorded a case where the man had to stretch himself, when the food was heard to enter his stomach with a loud gurgling sound. In other cases relief can only be obtained by vomiting, the feeling of distension becoming so intolerable that, rather than wait and strive to get the food down, the patient ejects the contents of the distended gullet through the mouth. An

<sup>1</sup> *Pathology of the Œsophagus*, p. 19.

<sup>2</sup> *Brit. Med. Journ.* 1895, vol. ii. p. 1425.

<sup>3</sup> *Schmidt's Jahrbuch*, 1859, vol. ci. p. 298.

example of such a case is recorded by Viti.<sup>1</sup> The patient was in the habit of making himself vomit, to relieve the feeling of weight which he suffered from after meals. He died from the rupture of a varicose vein in the œsophagus, and at the post mortem a sacciform dilatation was found just above the cardiac orifice.

The length of time after taking food before it is regurgitated varies. In some cases it is returned almost immediately, while in other, hours, and even days (Purton) may elapse. In any case, the food so ejected is found to be free of pepsin and hydrochloric acid, thus indicating that it does not come from the stomach. The longer the food remains lodged the more likely is it to decompose, with the result that the breath may become very offensive. Where the distension is considerable, the heart's action may be mechanically impeded and symptoms of faintness ensue. The degree of emaciation will depend upon the quantity of nourishment which finds its way into the stomach. Mucus and saliva collects sometimes to a considerable extent and is hawked up. Troublesome coughing is also occasionally present, and serves to produce attacks of vomiting.

**Diagnosis.**—It will be readily understood how apt such cases are to be set down as due to stricture. The length of time since the onset of the dysphagia, the age of the patient, and the general history of the case will largely assist towards a correct differentiation. But the most confirmatory evidence of dilatation will be found in the ease with which, in the majority of cases, a large-sized bougie may be made to pass into the stomach. That success, however, should follow such attempts, the passage of the bougie must only be tried when the gullet is empty; that is usually after the patient has vomited. As indicated by Morell Mackenzie,<sup>2</sup> even under these conditions difficulty is sometimes encountered owing to the twisting or doubling of the bougie upon itself.

**Prognosis.**—While it may be said to be impossible to cure this disease, much may be done to prolong life. When death is directly due to the dilatation, it is usually the result of inanition; hence it may be expected that the sooner the

<sup>1</sup> *Brit. Med. Journ. Epitome*, 1890, vol. ii. p. 65.

<sup>2</sup> *Diseases of the Throat and Nose*, vol. ii. p. 117.

ejection of the food, and the larger the amount of such ejection, the shorter is likely to be the patient's life. That life may be prolonged for several years is abundantly shown by some of the cases already quoted. Thus in Davy's case the symptoms were observed for ten years; in Purton's for twenty; in Hannay's for thirty; in Gradenwitz's for forty-three; and in Wilks' case, which was supposed to be congenital, the patient lived till he was 74 years old.

**Treatment.**—Much may be done by careful attention to diet, and, in some cases, by a properly regulated use of a feeding tube. The food taken should be in small quantities, in large part fluid, and taken at frequent intervals. The patient's feelings, however, will often prove the best guide both as to the quantity and quality of nourishment required. Every endeavour should be made to prevent an accumulation in the gullet. The use of a feeding tube, where considered necessary, not only enables a proper amount of nourishment to reach the stomach, but gives rest to the œsophagus, permitting the latter to recover a certain amount of its contractile power. Mermod, quoted by Solis-Cohen, records a case of rapid improvement in general health and in the local distressing symptoms by the use of the feeding tube. In cases where the dilatation is secondary to stricture, the latter will need to be treated in one or other of the ways already indicated for that condition.

CASE XL.—*Dilatation of the œsophagus supervening upon a fall.*

About fourteen days after a fall the patient began to have a feeling of fulness after eating, and a sense of pressure about the epigastric region. Two or three weeks later he experienced some difficulty in taking food, and tried to assist its passage by drinking warm water several times during his meal; only by so doing was he enabled to enjoy a whole meal. His dysphagia increased, and in order to get down his food he used to leave the table in the middle of a meal, walk up and down the room, taking deep inspirations and expirations. He would press with his hands upon the front of the lower part of the thorax, after taking a deep inspiration and closing his glottis. This method of manipulation brought him relief, allowing him to eat again. When in the recumbent position, fluid at times came up into his throat and mouth, and from time to time it happened that he awoke with his mouth full of fluid. He rapidly emaciated, and became greatly distressed and miserable. No organic mischief was discovered anywhere. He had a feeling of pressure round his chest, and he was much troubled with cough. On passing the tube of a stomach pump, no resistance was encountered. The treatment con-



sisted in allowing the patient to take only fluid or semi-fluid nourishment : in washing out his œsophagus every night before going to bed ; and in passing a tube into his stomach once a day. Both these latter measures he managed to carry out himself. He gradually improved. (Einhorn, 'New York Medical Record,' 1888, vol. xxxiv. p. 751.)

---

## CHAPTER XIII

ABNORMALITIES (*continued*). DIVERTICULA

ALTHOUGH rare, this condition is much more frequently met with than the last ; and from the fact that it has now been successfully treated by operation, it may be considered less serious. Numerous cases are to be found recorded, and it is more than probable many others escape observation. Butlin,<sup>1</sup> in a paper read before the Royal Medico-Chirurgical Society of London, gives illustrations of all the specimens met with in the London collections. Two exist in the Royal College of Surgeons, and three in the museums of the London hospitals. The condition does not always give rise to symptoms, and occasionally diverticula are accidentally met with in the course of a post mortem.

**Etiology.**—The origin of these pouches is usually ascribed to one of four causes : either they are (1) congenital, or they are dependent upon a (2) strictured condition of the canal below, or they result from (3) pressure within or (4) traction from without.

(1) *Congenital.*—In a paper read by Francis<sup>2</sup> before the Cambridge Medical Society, the author suggested three theories for their occurrence : firstly, that they might be analogous to the diverticula which were found in some of the Sauropsida and in ruminant animals—forming the first two compartments of the stomach ; secondly, that they were foetal varieties analogous to the œsophageal diverticulum from which the larynx, trachea, and lungs are formed ; and thirdly, that they resulted from a failure in the internal closure of a branchial cleft.

(2) *Stricture.*—In cases resulting from this cause, it is

<sup>1</sup> *Trans*, 1893, vol. lxxvi. p. 269.

<sup>2</sup> *Lancet*, 1887, vol. ii. p. 1271.

supposed that some spot above the obstruction, weakened through inflammation and ulceration, gradually yields, and on account of the repeated pressure to which it is subjected in every act of deglutition, the wall becomes forced out into a pouch. The condition is likened to similar pouches found in the bladder and rectum, where a stricture prevents the normal escape of the contents of the viscus.

(3) *Pressure*.—In this class it is assumed that there already exists naturally some predisposed weakened spot in the walls of the gullet, the continual subjection of which to the normal pressure exercised in deglutition leads to the formation of a pouch. Not therefore that there is undue pressure within, but that there exists abnormal weakness in the walls. One place which appears thus to be specially disposed is the junction of the pharynx with the œsophagus posteriorly. Here the inferior constrictor above merges with the circular muscle fibres of the œsophagus below, both being placed transversely; and since also this is the narrowest part of the canal, where anteriorly is situated the unresisting cricoid cartilage, greater pressure in deglutition is brought to play here than in any other part of the canal. Strangely nature seems to have failed in not compensating for this weakness, although it must be confessed that, considering the rarity of the disease, it may well be questioned whether we are wholly correct in blaming nature and not some other unnatural cause. It may be well to remark here that these particular diverticula are sometimes described as pharyngeal. Occurring as they do at the junction of pharynx and œsophagus, they have perhaps as much right to be associated with the one as the other; but considering, on the other hand, that the symptoms are almost always œsophageal in character, it would appear better to retain them in this connection.

Another cause of abnormal weakness has been indicated by Féré.<sup>1</sup> He found that on making a microscopical examination of the œsophagus of a new-born child, perpendicular to the long axis of the canal, there was a small region about one centimeter below the upper extremity of the tube, and in the median line anteriorly, where the muscular coat was completely absent.

<sup>1</sup> *Le Progrès Médical*, 1879, No. 7, p. 227.

PLATE VI.



Fig. 13.—DIVERTICULUM OF THE OESOPHAGUS.—The posterior wall of the pharynx and the diverticulum is laid open. Two directors mark the continuation of the gullet. (*Hunter an Museum, University of Glasgow.*)



Struthers, as quoted by Francis, points out an area of weakness a little below the bifurcation of the trachea, due to the absence of any material external support to the gullet in this situation.

(4) *Traction*.—By this method the wall of the œsophagus is acted upon by some external inflammatory influence, which in the process of healing and contraction leads to the formation of a funnel-shaped-like process. These diverticula are found most commonly opposite or near the bifurcation of the trachea. The reason for this lies in the greater frequency with which inflammatory processes take place in connection with the lymphatic glands situated in this region. A specimen was shown by Latham<sup>1</sup> to the Cambridge Medical Society in illustration of such a process. The patient died of phthisis. A large abscess cavity at the bifurcation of the trachea communicated with the œsophagus and simulated a traction diverticulum.

The pouches or, better, infundibuliform processes are usually directed transversely outwards, or obliquely upwards, so that their size is not materially affected by the lodgment of any quantity of food. There is risk, however, associated with small fragments becoming impacted. In such cases ulceration may be set up, leading to the formation of a septic abscess; and this latter, finding its way into some neighbouring structure or organ, may cause a fatal result. In a case reported by Leichtenstern,<sup>2</sup> perforation took place into the lung, and death ensued from pulmonary gangrene. Besides the pathological process involved in the formation of these diverticula, Francis, in his paper, adds a physiological one, in the action of the musculus pleuro-broncho œsophageus of Hyrtl and Cunningham.

Diverticula occasionally arise from the impaction of foreign bodies. In one sense these might be deemed pressure diverticula, but they differ in this respect, that they are essentially due to pressure, and not to any abnormal weakness in the walls of the gullet. In most of these cases the pouch simply forms a sac for the encystment of the foreign body, and must be considered as a means of cure; in other cases, however, it is possible, either from a gradual increase in the size of the sac

<sup>1</sup> *Lancet*, 1887, vol. ii. p. 1271.

<sup>2</sup> *Journal of Laryngology and Rhinology*, 1891, vol. v. p. 240.

while the body is retained, or a similar increase after its ejection, for a true diverticulum to be produced. In a case recorded by Hoffman,<sup>1</sup> a diverticulum resulted from the swallowing of a piece of broken china. The man, who had tried to commit suicide, died on the following day, and a hole was found in the wall of the uppermost region of the œsophagus lined with mucous membrane. The author regarded this as an instance of an acute diverticulum.

**Pathology.**—In structure diverticula vary. In some cases they possess a wall of mucous membrane, submucous tissue, and muscle; while in others there is an absence of any muscle tissue, the sac consisting of a dense substratum of fibrous tissue lined with mucous membrane. The existence of muscle, except around the orifice of the sac, is denied by Zenker,<sup>2</sup> who failed in a number of careful observations to detect its presence. If, for the present, traction diverticula be excluded, the other forms may be said to be either true hernial protrusions of the lining membrane, or possibly foetal varieties of the same nature as the normal diverticulum of the œsophagus, from which the lungs are developed. In size and shape they exhibit considerable varieties. In most instances the size depends upon the time the pouch has been in existence. Small at its origin, it enlarges from repeated fillings and continuous pressure. In some cases the opening into the pouch is much narrower than its body or fundus, giving the sac a pedunculated or pear-shaped appearance; in others the reverse conditions are found, and the orifice of the sac not only larger than the sac itself, but in excess of the calibre of the œsophagus in its continuity below. (See Pl. VI, fig. 13.)

As may be gathered from what has preceded, the most frequent position for diverticula is opposite the cricoid cartilage. As the sac increases in length it passes downwards between the gullet and the spinal column; and, owing to the resistant action of the latter, any increase in the bulk of the pouch causes pressure upon the œsophagus in front. This becomes greater the lower the tumour descends. By reason of the counter resistant action of the sternum, the œsophagus

<sup>1</sup> *Journal of Laryngology and Rhinology*, 1889, vol. iii. p. 293.

<sup>2</sup> *Cyclopædia of Medicine*, vol. viii. p. 58.

gets squeezed by the distended pouch between the spine behind and the manubrium in front.

As indicated in describing the etiology of diverticula, they are occasionally met with in other situations than that just described. Thus Reichmann<sup>1</sup> records three cases and Mintz<sup>2</sup> one where the diverticulum was found at the lower part of the canal. Moore<sup>3</sup> reports a case where the pouch, no larger than a pea, was found anteriorly at a point a little below the end of the trachea. Traction diverticula, as stated above, are most frequently found somewhere in the locality of the bifurcation of the trachea.

**Symptoms.**—As a rule it is not until the diverticulum has reached a sufficient size through the increasing accumulation of food, that the patient begins to complain of some sense of obstruction or oppression, localised usually at a spot on the neck or chest opposite the seat of impediment. Occasionally, however, obstruction takes place at the orifice of the pouch, independently of any distension of the sac itself. Intimately associated with the pain and feeling of oppression is the immediate relief experienced when the patient ejects the contents of the sac. This occurs in some cases involuntarily, but is more frequently effected by the patient himself. When the diverticulum exists in the neck, it can sometimes be felt as a tumour situated deeply beneath the gullet, and is observed to project laterally, or produce an appearance of fulness when food is taken. On pressing the swelling, as can be accomplished by the patient himself, the contents of the sac may be heard to gurgle into the mouth. The feeling of obstruction is occasionally felt to begin above and descend. This occurred in a case reported by Weinlechner,<sup>4</sup> who explained it by assuming that the difficulty first felt was at the orifice of the pouch, but as the latter filled, it caused greater pressure lower down. The reverse sensation has also been experienced—that is, the feeling of obstruction has appeared to ascend. Thus in one of Reichmann's three cases, when the feeling of difficulty in swallowing had risen to a cer-

<sup>1</sup> *Journal of Laryngology and Rhinology*, 1893, vol. vii. p. 233.

<sup>2</sup> *Ibid.* p. 232.

<sup>3</sup> *Trans. Path. Soc. Lond.* 1882, vol. xxxiii. p. 191.

<sup>4</sup> *Wiener med. Wochenschrift*, 1880, p. 36.

tain point, the patient noticed that food passed into the stomach. In this instance the empty diverticulum did not appear to cause trouble; but as the sac filled so the sense of pressure on the œsophagus, or rather the obstruction caused by the pressure, was felt by the patient to rise upwards, until the sac being finally filled, the excess passed downwards into the stomach. In other such cases the complete filling of the diverticulum implies total obstruction. In a case reported by Chavasse<sup>1</sup> such was the result, and gastrostomy had to be performed to prevent death from starvation. The length of time during which food may remain in a diverticulum varies. In some instances it amounts to days, and under such circumstances the contents are liable to decompose and the breath become foetid. Food regurgitated will be found to be free from any acid reaction and show no signs of having undergone digestion, thus proving its return from the œsophagus and not the stomach. A large diverticulum, occurring either in the neck or in the thorax, may produce serious symptoms from pressure on blood vessels and nerves; and even the heart's action may be impeded when the swelling projects forwards to any material degree in the posterior mediastinum.

**Diagnosis.**—But little difficulty is encountered in diagnosing many of those diverticula which occur in the neck. The existence of a tumour which is found only to form during deglutition, and to be capable of being emptied by pressure, may be said to be pathognomonic. Where, however, the diverticulum is situated in the thorax, some difficulty will arise in distinguishing the affection from stricture and dilatation.

Excluding such aids to diagnosis as may be elicited from the history of the case, its onset and progress, the most confirmatory evidence will be obtained from the use of a bougie. In any endeavour to pass an instrument when the diverticulum is filled with food, it will generally be found that the point of the bougie or tube will make its way into the distended orifice; while if an attempt be made when the pouch is empty, there is a chance of it escaping the opening and passing with ease into the stomach. Independently, however, of such a condition the bougie will, in the same case, at one time

<sup>1</sup> *Trans. Path. Soc. Lond.* 1891, vol. xlii. p. 82.



pass, while at another it will not. Weinlechner<sup>1</sup> believes this inconstancy to be due to a valvelike condition of the mucous membrane at the orifice of the diverticulum. Such a sequence of events will at once exclude stricture, but may still leave some doubt as to the alternative existence of dilatation. A few repeated passages of the instrument will, however, soon eliminate the latter, and the fact that a cavity is detected capable of being washed out will further aid towards a correct diagnosis.

**Prognosis.**—Unless some relief can be given, the prognosis is bad. According to von Bergmann,<sup>2</sup> thirteen out of twenty-one cases, or nearly 75 per cent., are fatal. Death usually occurs from inanition, and the length of life will naturally depend upon the amount of nourishment which can find its way into the stomach. In Weinlechner's<sup>1</sup> case the man was 64 years old, and he had had symptoms for thirteen years; in Chavasse's case, symptoms had existed for ten years; in both Mintz's and Whitehead's<sup>3</sup> cases the patients had suffered for eight years. From the fact that larger diverticula occur in the neck, the symptoms are usually acuter here than elsewhere. Diverticula due to traction do not as a rule give rise to obstruction, and therefore are rarely fatal from that cause; but their risk consists in the danger of perforation, and the sudden onset of serious symptoms due to secondary complications.

**Treatment.**—Something may be done to temporarily mitigate the sufferings of the patient and prolong life, but within recent years a great deal has been accomplished in the way of effecting a cure. As regards relief, a careful selection of food should be made. Solids should be avoided except when they are well minced and mixed up with fluid. By means of a tube the cavity should, if possible, be washed out once a day, so as to prevent accumulation. When such conservative measures fail, and the patient shows signs of sinking from starvation, gastrostomy must be performed. In the case reported by Whitehead,<sup>3</sup> the patient, otherwise on the verge of death, lived for six years after the operation. Berkham<sup>4</sup> has

<sup>1</sup> *Wiener med. Wochenschrift*, 1880, p. 33.

<sup>2</sup> Langenbeck's *Archiv*, 1892, Bd. xliii. Heft i. p. 1.

<sup>3</sup> *Lancet*, 1891, vol. i. p. 11.

<sup>4</sup> *Berliner klin. Wochenschrift*, 1889, p. 227.

succeeded in treating a case with a good result by careful catheterisation. The diverticulum was situated in the neck. By using a conical guttapercha bougie, which after being warmed could be bent to the required shape, it was found possible to press on the inferior lip of the orifice of the pouch, so that by repeatedly passing and pressing the lip it became permanently displaced. The result was that fluids which before had always passed into the diverticulum, now found their way freely and easily into the canal of the œsophagus below.

The most successful treatment of cervical diverticula is, however, now to be found in total extirpation. The first operation of this kind appears to have been performed by von Bergmann.<sup>1</sup> The pouch was about the size of a pear, occurring in a woman aged 38. She vomited all food almost immediately after taking it. After the removal of the sac, the patient was completely cured. More recently Kocher<sup>2</sup> has successfully treated two cases in a similar manner; and in April 1893 Butlin<sup>3</sup> reported to the Royal Medical and Chirurgical Society of London a case in which he had effected a complete cure by excision. König<sup>4</sup> records two cases in which successful excision was performed; and Mandach<sup>5</sup> removed one from the right side of the neck of a man who for several years had had increasing difficulty in deglutition, and at last total obstruction. In a case reported by Mixer,<sup>6</sup> a pouch about the size of an egg, and situated to the left and behind the œsophagus, was successfully excised. Thus it may be said that, so far as one is permitted to draw conclusions from these five cases, the operation of excision of a cervical diverticulum is attended with but little risk, and is capable of accomplishing a perfect cure.

For the operation for excision of diverticula see Chapter XVI. on operations on the œsophagus.

<sup>1</sup> Langenbeck's *Archiv*, Bd. xliii. Heft i. p. 1.

<sup>2</sup> *Journal of Laryngology and Rhinology*, 1892, vol. vi. p. 257.

<sup>3</sup> *Trans. Medico-Chirurgical Soc. Lond.* 1893, vol. lxxvi. p. 269.

<sup>4</sup> *Berliner klin. Wochenschrift*, 1894, No. 42, p. 947.

<sup>5</sup> *Journal of Laryngology and Rhinology*, 1895, vol. ix. p. 285.

<sup>6</sup> *Brit. Med. Journ. Epitome*, 1895, vol. ii. p. 26.

CASE XLI.—*Pressure diverticulum of the œsophagus situated in the neck.*

A farmer, aged 49, was admitted into the Birmingham General Hospital. The history given was one of constantly increasing difficulty in swallowing, extending over a period of ten years. His main symptom was that food was brought back in a softened but undigested condition at varying times after being swallowed. Inspection and palpation of the neck failed to detect any abnormality. An attempt to pass a bougie failed, but the instrument was arrested seven inches from the teeth. Immediately after the endeavour, portions of an orange and other food that had been taken some hours previously were vomited in an undigested condition. He was greatly emaciated, and requested that an opening might be made in his stomach. He died exhausted three days after the operation. At the post mortem a diverticulum was found arising from the œsophagus at its upper end. The sac was of a flattened pear shape, four inches deep from the level of the arytenoids, three and a half inches broad, and two and a half inches thick antero-posteriorly. Mouth one inch in diameter, and capacity six ounces. On its anterior wall the œsophagus commenced an inch and a half below the base of the arytenoid cartilages. When the sac was full of fluid, the slitlike opening in the œsophagus was compressed and firmly closed. (Thomas F. Chavasse, 'Trans. Path. Soc. Lond.' 1891, vol. xlii. p. 82.)

The subject of diverticula has been so exhaustively set forth in an article by Zenker and von Ziemssen in their *Cyclopædia*,<sup>1</sup> that the reader is advised to consult it for any further information than has been given here. A more recent contribution to the subject will be found in the '*Deutsches Archiv für Klinische Medicin*,'<sup>2</sup> by Huber.

---

## CHAPTER XIV

ABNORMALITIES (*continued*). MALFORMATIONS OR DEFORMITIES.  
 CONGENITAL ATRESIA. CONGENITAL STENOSIS. TORSION

**Malformations or Deformities.**—Some of these are to be found in monstrosities, but those to be dealt with here are only such as occur or exist in the living. That malformations are rare may be concluded from the fact that Mackenzie,<sup>3</sup> in a particularly exhaustive article upon the subject, and as the

<sup>1</sup> Vol. viii. p. 52.

<sup>2</sup> 1894, Bd. lii. p. 103.

<sup>3</sup> *Diseases of the Throat and Nose*, vol. ii. p. 217.

result of a searching investigation extending back to the year 1670, could find no more than sixty-two recorded instances; and notwithstanding the many more complete means now existent for reporting and collecting cases, I can only find, since his publication in 1881, twelve additional ones.

The malformations met with in life are congenital atresia or deficiency, congenital stricture, congenital diverticula, and torsion. Of these, congenital diverticula have already been dealt with. Of the remainder, congenital atresia or deficiency is by far the most common. Thus of my twelve cases nine were of this nature. They have been reported respectively by Steele,<sup>1</sup> Leven,<sup>2</sup> Shattock,<sup>3</sup> Boisvert,<sup>4</sup> Mekins,<sup>5</sup> Machel,<sup>6</sup> Vince,<sup>7</sup> Grandon,<sup>8</sup> and Taylor.<sup>9</sup> The remaining three were two cases of congenital stricture by Turner<sup>10</sup> and Crary,<sup>11</sup> and one of torsion by Monakow.<sup>12</sup>

**Congenital atresia.—Pathology.**—In these cases it is usually found that the pharynx or œsophagus terminates in a cul-de-sac somewhere about the level of, or a little below, the cricoid cartilage. Extending from this, for a distance of about an inch, is often a fibrous cord which terminates in the lower segment of the gullet, that part which is connected with the stomach. The part of the œsophagus continuous with the stomach is usually normal; but on tracing its channel upwards, it is very frequently found connected by a small opening with the trachea. In all but one case, that of Steele's, this communication was found. In this particular instance the two segments of the gullet were an inch and a half apart, with no cord or band of connection between them. The cause of this defective condition of the œsophagus, whether dependent upon some disease in early foetal life or some incom-

<sup>1</sup> *Lancet*, 1888, vol. ii. p. 764.

<sup>2</sup> Virchow's *Archiv*, 1885, Bd. cxiv. p. 553.

<sup>3</sup> *Trans. Path. Soc. Lond.* 1889, vol. xli. p. 87.

<sup>4</sup> Quoted by Shattock.

<sup>5</sup> *Ibid.*

<sup>6</sup> *Journal of Laryngology and Rhinology*, 1891, vol. v. p. 239.

<sup>7</sup> *Brit. Med. Journ.* 1893, vol. i. p. 50.

<sup>8</sup> Solis-Cohen, *Annual of the Universal Medical Sciences*, 1892, vol. iv.

<sup>9</sup> *Journal of Laryngology and Rhinology*, 1893, vol. vii. p. 232.

<sup>10</sup> *Trans. Path. Soc. Lond.* 1885, vol. xxxvi. p. 185.

<sup>11</sup> *New York Med. Journ.* 1891, vol. liv. p. 50.

<sup>12</sup> *Journal of Laryngology and Rhinology*, 1893, vol. vii. p. 266.

pleteness in the process of development, I shall not consider here; the reader is referred to Shattock's full discussion of the subject accompanying the record of his case in the *Pathological Society's 'Transactions.'*

**Symptoms.**—It is not long after the birth of the child that indications are prominently given that there is obstruction in the gullet. Almost immediately after the child takes the breast, or has been fed with milk, it vomits, returning all that has been swallowed; so that if it is possible to collect what is ejected it will be found to equal in quantity that given. In some cases dyspnoea supervenes upon the return of the milk, due to some of it finding its way into the larynx. Although no food enters the stomach, meconium may be passed. The child rapidly emaciates and dies. The length of life depends upon the state of nutrition of the child. In Leven's case, life was prolonged for eight days; but in the majority of instances death has occurred on the second or third day.

**Diagnosis.**—The passage of a bougie will at once detect the existence of obstruction. As a rule the instrument will be found not to pass much beyond the cricoid cartilage; that is to say, a distance of from three to four inches from the lips. Independently, however, of the passage of a bougie, the sudden and complete return of all food will in nearly all instances sufficiently indicate the true nature of the case.

**Treatment.**—Anything operative upon a child so young is of itself of considerable gravity; nevertheless, if life is to be prolonged it must be by operation. At present no other alternative than such a severe measure as gastrostomy seems at all reasonable. The condition, however, itself is sufficiently grave to warrant it. Steele tried it in his case, but death ensued twenty-four hours after. If it should ever prove successful, then Holmes's suggestion of cutting down upon the upper cul-de-sac and endeavouring to get a connection between the two segments, might later be considered. It must always be remembered that the unfortunate complication of a communication of the lower segment with the trachea, which exists in the majority of cases, renders every endeavour less likely to be successful than might otherwise be expected.

CASE XLII.—*Congenital atresia of the œsophagus.*

A. S., aged 24 years, was delivered of a female child. The birth was premature, occurring at the eighth month of pregnancy. Respiration was established with difficulty. The child suckled very imperfectly, though the mother had a full breast of milk. On attempting to feed it with milk and water from a spoon, swallowing took place; but after an interval varying from a few seconds to two or three minutes, the child became livid about the lips. Attempts to nourish it *per rectum* failed. After the first passage of meconium, no action of the bowels took place. The child became more feeble and emaciated, and died four days after birth. At the post-mortem examination, the pharynx was found to end in a cul-de-sac, a little below the level of the cricoid cartilage. The œsophagus terminated on the posterior surface of the trachea, about halfway between the cricoid cartilage and the bifurcation. On making an opening through its coats, just above its cardiac orifice, a probe could be passed upwards into the trachea. (Howard Marsh, 'Trans. Path. Soc. Lond.' 1876, vol. xxvii. p. 149.)

CASE XLIII.—*Congenital atresia of the œsophagus.*

Mrs. B. in her first confinement gave birth to a full-time female child, apparently quite strong and healthy. Everything the child took, either from the breast or spoon, was at once regurgitated through the nose. A soft catheter, when introduced, passed in five or six inches; but on injecting milk through it, regurgitation ensued immediately, the catheter having become coiled up apparently in a cul-de-sac. The child died about forty-eight hours after birth. At the post-mortem, the œsophagus ended in a pouchlike dilatation an inch and a half below the laryngeal orifice. From the extremity of the pouch a fibrous cordlike prolongation could be traced for about two inches. A probe passed through the cardiac orifice, after opening the stomach, showed that the gastric extremity of the œsophagus was represented by a muscular tube of about the normal calibre below, but becoming smaller and thinner as it passed upwards behind the œsophageal pouch above mentioned, and finally opening into the trachea in the fibrous space behind the cricoid cartilage and the first tracheal ring. (J. Foster Vince, 'Brit. Med. Journ.' 1891, vol. i. p. 14.)

**Congenital stenosis.**—In 1885 Turner<sup>1</sup> showed, at the Pathological Society of London, a specimen of stenosis of the lower end of the gullet, removed from a child aged 18 months. Besides this case and one reported by Crary<sup>2</sup> in 1890, no other instances have apparently been recorded since those by Fagge<sup>3</sup> and Wilks,<sup>4</sup> found quoted in most textbooks on the subject.

<sup>1</sup> *Trans. Path. Soc. Lond.* 1885, vol. xxvi. p. 185.

<sup>2</sup> *New York Med. Journ.* 1891, vol. liv. p. 50.

<sup>3</sup> *Guy's Hospital Reports*, 3rd series, vol. xvii. p. 413.

<sup>4</sup> See above, page 113.

Wilks's case has already been referred to under Dilatation of the Œsophagus, the latter being greatly enlarged above the seat of constriction. In von Ziemssen's 'Cyclopædia of Medicine'<sup>1</sup> are to be found reports of three cases where the stricture was situated at the upper end of the gullet, and two others where the stricture—as in the cases of Wilks and Fagge—was located at the lower part. Thus there only appear on record eight cases of this affection. With the exception of Turner's and Crary's cases, all the patients lived to a good age. The degree of dysphagia varied. Thus in two cases it commenced early, in another the patient was over 40 years old before he was troubled with it. In nearly all, life was easily maintained by a careful attention to diet, and it seems likely that in Turner's case, where the child only lived eighteen months, life might have been prolonged had attention been paid to the feeding earlier; at least, such was the opinion of the author. Any indiscretion in diet is liable to invoke spasm around the constricted orifice, and hence for a time increase the difficulty of deglutition. The passage of a bougie will in most cases determine the nature of the obstruction; in the case of Turner's child, however, some doubt seems to have existed as to whether the bougie entered the stomach.

The conclusions to be drawn from these cases seem to be that life may be prolonged to comparatively old age, with freedom from any material discomfort, so long as the food taken is carefully selected, well masticated, slowly eaten, and either mixed with or followed by fluids. As regards treatment of the stricture, Crary's case would suggest that good may result from its dilatation with bougies. But whether this is likely to follow in all cases is doubtful, for the conditions are not comparable to such as exist in cicatricial stricture. Operations, especially those of a cutting character, are not advisable.

CASE XLIV.—*Congenital stricture of the œsophagus.*

A man aged 21 years presented himself at the Roosevelt Hospital Dispensary in September 1889 with the history of having had difficulty in swallowing ever since birth. Even when a nursing infant the milk had been frequently regurgitated. At the age of 12 years he had been troubled

---

<sup>1</sup> Vol. viii. p. 18.

by frequent aggravations of his trouble, extending over long periods. At such times he had been unable even to swallow water, and he became so exhausted that he had to remain in bed until the stricture relaxed sufficiently to allow of his taking fluids. Under ordinary circumstances, he said, he had been unable to take any solid food except when very minutely divided, and that even then it had become necessary for him to leave the table before finishing a meal in order to relieve himself of some of the food which he had taken. When first seen at the dispensary he showed signs of malnutrition and was almost too weak to walk. After much difficulty a bougie (No. 20 French) was passed through the stricture, which was found to be a long one situated fourteen to sixteen inches from the teeth, diminishing in calibre as it approached the orifice of the stomach, near which opening it was evidently located. A bougie of this size was passed three times a week for about two months, at which time it passed quite easily. Since that time the stricture had been very gradually dilated, until it would admit an instrument about eight millimeters in diameter. Only after the first introduction was there any bleeding, and that was very slight. The result of the treatment had been very satisfactory. He was able to drink quite easily, and could take almost all kinds of solid food except the firmer meats. (George W. Crary, 'New York Med. Journ.' 1891, vol. liv. p. 50.)

**Torsion of the œsophagus.**—Monakow<sup>1</sup> reports an unusual case of spasmodic dysphagia which proved to be due to torsion of the gullet about its axis. The patient was 32 years old, and was attacked periodically with difficulty in swallowing. Food descended as far as the sternal region, and was regurgitated after some hours. Death followed from inanition. At the post mortem it was found that nothing could pass until the torsion was redressed. In the case reported by Davy,<sup>2</sup> and already referred to under Dilatation, a twist or volvulus was found in the œsophagus at its cardiac extremity. In order to facilitate swallowing, the patient used to stretch himself, and the author's opinion was that in thus acting he, so to speak, undid the twist.

---

## CHAPTER XV

EXTERNAL INFLUENCES : PRESSURE. PERFORATION. DISTORTION

IRRESPECTIVE of diseases which may be said to be directly connected with the walls of the œsophagus, there are certain

<sup>1</sup> Michael, *Journal of Laryngology and Rhinology*, 1893, vol. vii. p. 266.

<sup>2</sup> See above, page 113



influences exercised upon it from without which, from the nature of the symptoms produced, are liable to be mistaken for an affection of the tube itself. Thus it may be pressed upon, perforated, or distorted.

**Pressure.**—The commonest cause of pressure is aneurysm, and among other causes are enlarged glands, tumours, abscesses, a distended pericardium, enlarged auricles (Bristowe), and backward dislocation of the sternal end of the clavicle.

Aneurysms which cause pressure on the œsophagus mostly arise from the aorta, but in rare instances they have been connected with other large neighbouring vessels.

The symptoms at the early stage, besides those peculiar to the disease itself, are of the nature of some difficulty in swallowing. This difficulty, even when at its worst, rarely reaches the acute stage of that found in stricture; and the fact that in so many cases of aneurysm of the thoracic aorta there is an absence of all dysphagic trouble, shows that its appearance in any particular case must depend upon certain special relations between the aneurysm and the gullet. That the dysphagia is never severe, finds probably a correct explanation in two causes suggested by Knott:<sup>1</sup> one, the absence of any interference with the normal peristaltic action of the muscle wall; and the other, the limit of the pressure to one side. To these it would seem right to add the ease with which the gullet, from its loose anatomical connections, can adopt itself to any other position.

In cases of prolonged pressure from aneurysm, attacks of hæmorrhage may take place; these, only slight at first, may terminate in a fatal copious gush. It appears that the process by which perforation is brought about is somewhat complicated. Thus Zenker<sup>2</sup> states that the pressure of the aneurysm causes a circumscribed sloughing of the mucous membrane. When the slough separates an ulcer forms, and by its extension a communication is effected between the gullet and the aneurysm.

Pressure from enlarged glands is possibly almost as frequent as that from aneurysm. By enlarged glands is meant

<sup>1</sup> *Pathology of the Œsophagus*, p. 217.

<sup>2</sup> *Cyclopædia of Medicine*, p. 115.

the thyroid in the neck, and the bronchial lymphatic glands in the region of the bifurcation of the trachea. Goitre was in Mackenzie's experience the commonest of all causes of pressure, particularly that form of it known as constricting goitre. A substernal bronchocele may also cause pressure. Enlarged lymphatic glands, usually tubercular, exist more frequently in children than in adults. Enlargement of the cervical glands may exercise pressure upon the œsophagus in the neck; it is more usual, however, for the glands about the root of the lung to press upon the gullet in that region. Pressure from tumours, such as carcinoma, sarcoma, lymphoma, and lympho-sarcoma, may take place in any part of the course of the gullet. It is more frequent, however, with the exception of carcinoma of the thyroid, for these malignant growths to attack the posterior part of the canal, taking their origin from the spinal column. In a case presented by Cahill<sup>1</sup> to the Pathological Society of London, a lymphomatous tumour was situated between the œsophagus and the trachea, below the level of the cricoid. It embraced the sides both of the gullet and the trachea. Churton<sup>2</sup> records a case of sarcoma of the lungs and bronchial glands causing stenosis.

Among innocent tumours, exostosis of a vertebra is mentioned by some authors as having given rise to compression.

Pressure from abscess occasionally occurs in cases of spinal caries. In a case which came under my own observation, the abscess was seated behind the upper part of the sternum; the child had some little difficulty in swallowing both solids and fluids, always experiencing during the endeavour a disagreeable choking sensation. His most distressing symptoms were, however, connected with his breathing. The case is recorded in the 'Annals of Surgery.'<sup>3</sup> A case reported by Ballot<sup>4</sup> would appear to have been of a somewhat similar nature. Although there was definite difficulty in deglutition, and great impediment to breathing, the abscess at

<sup>1</sup> NOTE.—It should be stated that the committee appointed by the society to further investigate this case reported subsequently that it believed the tumour to be a carcinoma, and in all probability to take its origin in the œsophagus.—*Trans. Path. Soc. Lond.* 1891, vol. xlii. p. 91.

<sup>2</sup> *Brit. Med. Journ.* 1891, vol. i. p. 648.

<sup>3</sup> 1883, vol. ix. p. 193.

<sup>4</sup> *Dublin Medical Press*, vol. vii. p. 23.

the post mortem was proved to be located rather behind the pharynx than the œsophagus, and so exercised pressure upon the larynx and this part of the alimentary canal. Hayden<sup>1</sup> published a case where an abscess was situated between the trachea and the œsophagus. Although this is quoted as an illustration of external pressure, it was believed in reality to have had its origin in an ulcer of the œsophagus, which had subsequently led to suppuration in the pericœsophageal connective tissue.

It must be remembered that in nearly all cases of compression of the œsophagus in the neck and in the upper part of the thorax, the dysphagia will be associated with symptoms of dyspnœa. The amount of pressure sufficient to produce difficulty of swallowing will almost certainly produce greater difficulty in breathing. This association of dyspnœa with dysphagia will in many cases serve to distinguish between obstruction the result of external influences, and that arising from disease of the canal itself.<sup>2</sup>

**Perforation.**—Many of the causes already given as productive of pressure may in their later stages result in perforation. Aneurysm, as indicated above, gives rise to hæmorrhage; perforation by external malignant growths may cause a like symptom. Tubercular glands in the process of suppuration may adhere to the walls of the gullet, and finally ulcerate into its canal. Voelcker<sup>3</sup> has recorded such a case, and in his paper he states that out of 2,504 post mortems performed at the Hospital for Sick Children, he was able to find three other cases of caseous glands rupturing into the gullet. In Voelcker's case no symptoms existed during life to indicate the existence of perforation. In two out of the three collected cases, the glands had also ruptured into the air passages.

The same author<sup>4</sup> reports an instance of a boy, aged 6 years, who for some time had suffered from empyema. After the thoracic cavity was opened, it was found that fluids taken by the mouth found their way out through the artificial thoracic opening. At the post mortem two openings

<sup>1</sup> *Trans. Path. Soc. Dublin*, 1865, p. 143.

<sup>2</sup> See page 71 for exceptions in cases of carcinoma of the œsophagus.

<sup>3</sup> *Trans. Path. Soc. Lond.* 1891, vol. xlii. p. 87.

<sup>4</sup> *Medical Press and Circular*, 1890, vol. ii. p. 629.

were found in the gullet, one opposite the eighth dorsal vertebra and the other a little below it.

**Distortion.**—It is rarely that the œsophagus is so bent upon itself that symptoms of obstruction show themselves. Hacker<sup>1</sup> has investigated the effects of lateral curvature of the spine upon the œsophagus. His paper is illustrated, and he shows how in two out of the five figures given, difficulty is encountered in the passage of a bougie. As might be expected, it is where the primary and compensatory curves are acute.

## CHAPTER XVI

### OPERATIONS

- |  |  |
|--|--|
| 1. INTRODUCTION OF BOUGIES,<br>FORCEPS, PROBANGS, EX-<br>TRACTORS, &C. | 5. EXTERNAL ŒSOPHAGOTOMY<br>(THORACIC) |
| 2. INTERNAL ŒSOPHAGOTOMY   | 6. ŒSOPHAGOSTOMY                       |
| 3. ELECTROLYSIS  | 7. EXCISION OF DIVERTICULA             |
| 4. EXTERNAL ŒSOPHAGOTOMY<br>(CERVICAL)                                 | 8. ŒSOPHAGOPLASTY                      |
|  | 9. ŒSOPHAGECTOMY                       |

THE operations to be described here are those only which directly implicate the gullet itself. Although gastrotomy and gastrostomy are both operations performed as a part of the treatment of certain diseases affecting this region, they will not be dealt with here, but will be found fully described in the chapter devoted to operations upon the stomach, at the conclusion of the section which deals with the surgical affections of that region.

**1. Introduction of bougies, forceps, probangs, extractors, &c.**—For the passage of instruments the patient should, if possible, be seated on a chair or propped up in bed, and the surgeon should stand in front or on the patient's right side. The head should be slightly thrown back, and securely held by an assistant. The arms also, especially in the case of children, should be secured either by a third assistant or enclosed in a binder passed round the chest. To keep the mouth open a gag may be used, and preferably an ordinary wine-bottle cork.

<sup>1</sup> *Wiener med. Wochenschrift*, 1887, p. 1494.

When possible and deemed advisable, the patient should be got to swallow a little olive oil or glycerine; failing this the instrument should be smeared with some lubricant. Either by friction or hot water it should be previously warmed.

In the case of pliable instruments, these should be previously bent to the required curve and then taken in the right hand of the surgeon and carefully conducted to the back of the pharynx. The end of the tongue secured by the operator between the fingers and thumb of his left hand covered with a towel or piece of lint, will help to draw the larynx forwards, and give a means also of somewhat steadying the patient's head. In some cases it will be found better to depress the tongue with the finger, and guide the end of the instrument over the glottis. Immediately the instrument touches the back of the pharynx, the patient will retch; but as long as there is no real difficulty in respiration, indicative of its being within the larynx instead of within the gullet, it should be steadily pushed on. Further aid to its passage will be obtained by inducing the patient to swallow. By so doing a normal peristaltic action takes place, which will be felt either to carry the instrument on, or materially facilitate its downward movement on pressure. Solis-Cohen<sup>1</sup> finds that in dilating strictures in the upper part of the gullet, the passage of bougies is much facilitated by drawing the larynx and trachea forwards between the thumb and fingers of the disengaged hand at the moment that the obstruction is reached by the dilating instrument.

Gentleness must in all cases be exercised. Any hitch in the progress of the instrument should not be overcome by force, but time should be allowed for the subsidence of spasm. If advance is still impeded the instrument should be withdrawn, and the endeavour renewed.

The question of the administration of an anæsthetic has already been discussed, and rather than occupy space here by repeating the arguments for and against its administration, the reader may be referred back to page 28.

It is useful to remember, in the introduction of bougies or tubes, that in the adult the distance between the incisor teeth

<sup>1</sup> *Journal of Laryngology and Rhinology*, 1887, vol. i. p. 196.

and the orifice of the œsophagus is from five to six inches, and the length of the gullet itself from nine to ten inches. Hence the cardiac orifice will be distant from the teeth from fourteen to sixteen inches.

**2. Internal œsophagotomy.**—The cutting of a stricture from within the canal necessitates the passage of the cutting instrument, or œsophagotome, through the contracted portion. Hence, prior to its introduction, it must be ascertained by the passage of bougies that the channel is sufficiently large. There are different forms of œsophagotome, but the common feature underlying all is the presence of one or two concealed blades located at the distal extremity of the instrument, and capable of being projected to the required distance by mechanical contrivances placed in the handle.

In the manner already described for the introduction of bougies &c., the instrument is passed down the œsophagus until it is judged that the bulbous cutting extremity is beyond the seat of stricture. The blade or blades is or are then made to project, and by a rapid pull outwards, of sufficient distance to traverse the length of the stricture, the latter is divided. The process may be repeated two or more times if thought necessary. To prevent any union of the cut surfaces, bougies should be passed within the course of a day or two. For dangers in connection with this operation see page 93.

**3. Electrolysis.**—Considerable use has been made of this method of treatment in strictures of the œsophagus; and, as already indicated in discussing that part of the subject, much success has attended its employment. I cannot do better than quote Steavenson<sup>1</sup> on the 'Uses of Electrolysis in Surgery,' for the manner of putting this method into practice.

'A long flexible electrode, like an ordinary œsophageal bougie, is required, to which can be attached olivary metal ends of various sizes, as in the case of some of the electrodes used for stricture of the urethra and rectum. The electrode is connected with the negative pole of the battery, that connected with the positive pole being placed on some indifferent part of the body. A current strength of five milliampères is generally employed, and the current allowed to flow for fifteen

<sup>1</sup> Page 91.

or twenty minutes, unless the electrode passes the obstruction in a shorter time. It will be found, as in the case of strictures in other parts, that recontraction does not take place so rapidly as after dilatation, and that usually after a week's interval a bougie one size larger can be passed than that used on the former occasion. A perforated electrode has been used which will pass over a celluloid guide so as to diminish the risk of its passing into a pouch by the side of the œsophagus, or of its decomposing laterally too much of the cancerous tissue of a malignant stricture, and by this means making an opening into the posterior mediastinum. The guide is sufficiently small to pass through the stricture and thus direct the passage of the electrode. As with other forms of treatment of œsophageal stricture, electrolysis gives more prospect of success with the fibrous variety than with the malignant.'

Campbell,<sup>1</sup> in several cases which he successfully treated, gradually increased the strength of the current from five to twenty-five milliampères. Painter,<sup>2</sup> another successful operator, placed the positive pole within the constriction; and in the case which he records, the application was made three times a week. After the fifteenth application meat and bread could be swallowed. After twenty-five applications, lasting three months, the patient could eat without regurgitation so long as the meat was finely cut up.

4. **External œsophagotomy (cervical).**—This operation is usually performed on the left side of the neck, except in such cases where the position of the impacted body suggests that removal would be more easily effected on the right.

The patient is placed in the supine position, with the shoulders slightly raised and the head thrown back and rotated to the right side. The side of the neck is shaved free of any hairs, and the skin properly cleansed and prepared as for any ordinary antiseptic operation. The surgeon, standing on the left side of the patient, ascertains the necessary landmarks: the upper border of the thyroid cartilage, the sternoclavicular articulation, and the anterior border of the sternomastoid. The skin being steadied between the fingers and thumb of the left hand, an incision is carried along the margin

<sup>1</sup> *Journal of Laryngology and Rhinology*, 1892, vol. vi. p. 573.

<sup>2</sup> *Ibid.* 1888, vol. ii. p. 418.

of the anterior border of the sterno-mastoid from about three-quarters of an inch above the sterno-clavicular articulation to the upper border of the thyroid cartilage. By this incision the skin, superficial fascia, and platysma myoides are divided, together with possibly some superficial veins; these latter should be at once secured, and if by any chance it is observed before making the incision that the line is crossed by either the anterior or external jugular, these should be first double-ligatured and then divided.

The next stage of the operation consists in a careful deep dissection down to the gullet. This should be effected mostly by snipping, teasing or tearing the parts asunder, and not by any free cutting.

As soon as the anterior border of the sterno-mastoid is exposed it should be hooked aside, and similarly the carotid sheath—with its vessels and nerves when sufficiently isolated—should be drawn outwards and included with the muscle in the grasp of the same retractor. The omo-hyoid muscle, which crosses the space at its upper part, if it cannot be hooked aside, must be divided as near as possible to its attachment to the hyoid bone, so as to avoid any interference with its nerve supply through the descendens noni. The sterno-thyroid and sterno-hyoid together with the thyroid gland must be drawn slightly inwards. To facilitate this lateral retraction of parts, the head should be slightly flexed. With a little further careful dissection through the deep fascia, the œsophagus will be reached lying beneath the trachea, which must also be drawn gently to the opposite side in order to better expose the former. In this latter part of the dissection the thyroid arteries should be avoided, or, if division is necessary to gain freer access, they should be first secured. The recurrent laryngeal, which runs upwards between œsophagus and the trachea, must be carefully avoided; any injury to it would lead to impairment of the voice.

The final stage of the operation consists in opening the gullet. If the operation be for an impacted body which can be easily felt, no further guide is necessary for the incision. If, on the other hand, the œsophagus is in its normal flaccid condition, a bougie or sound should if possible be introduced by the mouth and made to project at the point at which the



canal is to be opened. With a sharp scalpel the point of the projecting instrument is cut down upon and a small longitudinal incision made. If no instrument can be inserted, then the walls of the œsophagus should be secured at two points by two pairs of forceps, the parts between them drawn slightly forwards, and the knife carefully but quickly plunged into the canal. The incision can be enlarged by snicking with a pair of scissors in an upward or downward direction, or dilating with the finger or a pair of dressing forceps. To secure the opening, the edges may be transfixed with a silk suture, or held with two pairs of artery forceps. Any hæmorrhage is not serious.

Some difference of opinion exists as to the advisability of closing the œsophageal wound. If it is decided to do so, the mucous membrane should be stitched separately. If the muscle wall be included in the same stitch, there is a greater danger of the sutures cutting through. The external wound may be closed for a considerable extent; and to remove the possibility of such serious consequences as would ensue from any leakage from the œsophagus, a small drainage tube should lead from the deepest part to the surface at the lower end of the wound; or no attempt should be made to close the wound which is stuffed with iodoform gauze. Either tube or stuffing may be removed in the course of a few days if all seems doing well. When the patient is returned to bed, it is advisable to limit the movement of the head as much as possible, either by the way in which the bandages are applied, or by placing sandbags on each side of the head.

If the patient's strength will admit, all nourishment for some days should be given by nutrient enemata; but if more food is required than can be thus administered, it should be given by the passage of a tube carefully introduced down the gullet.

5. **External œsophagotomy (thoracic).**—The operation of intrathoracic œsophagotomy practised by Portarca<sup>1</sup> on the dead subject, and proposed by him for cases of impacted foreign body in the mediastinal portion of the gullet, is thus described: 'The body being turned over on the belly, a vertical incision, between five and six inches in length, the middle of which cor-

<sup>1</sup> *Brit. Med. Journ. Epitome*, 1894, vol. ii. p. 79.

responds to the fourth dorsal spine, is made midway between the internal border of the scapula and the spines of the dorsal vertebræ. The following structures are divided in succession : the aponeurosis of the trapezius, and at the lower part of the wound some of its muscular fibres ; the aponeurosis and lower fibres of the rhomboideus major, the aponeurosis between the two serrati muscles ; then, after separation of the sacro-lumbales from the longissimus dorsi, the transversalis colli. The third, fourth, and fifth ribs having been thus exposed, a piece of bone about an inch in length is removed from each, the internal section of each rib being close to the transverse process of the corresponding vertebra. The pleura is now carefully stripped from the inner fragments of the ribs and the front of the spine, and the vena azygos exposed, in front of which will be seen the œsophagus at a depth of four inches from the wound of the skin.'

Weir<sup>1</sup> reports 'having rehearsed on the cadaver the operation, revived by Quénu, of resecting the upper left ribs posteriorly.' Not only does this method readily expose the œsophagus, but it admits of the left bronchus being reached without invading the pleural cavity. For a full description of the operation, Quénu's paper<sup>2</sup> should be consulted.

6. **Œsophagostomy.**—The steps of the operation as far as to and including the opening of the œsophagus are the same as above described. The edges of the œsophageal wound are then caught up by forceps, and by means of gentle traction united by a silk stitch or two to the margins of the skin. The depth of the gullet will not admit of too intimate a connection between it and the surface, it should therefore only be sufficiently secured to admit of a moderately easy and safe insertion of the tube. This tube—which, from its partial resemblance to a tracheotomy one, might be designated an œsophagotomy tube—measures about three inches in length below the bend and about one inch above it. To its short end is fixed a shield, so that after the introduction of the tube into the gullet, it is secured in position by tapes tied round the neck. As in the operation of tracheotomy, any undue gaping of the wound above and below the tube may be brought together by a few stitches. In feeding the patient a much

<sup>1</sup> *New York Med. Journ.* 1891, vol. liv. p. 639.

<sup>2</sup> *Revue de Chirurgie*, 1891, p. 265.

longer tube and one of a less calibre may be inserted through the fixed one, so as to make sure that none of the liquid material given finds its way into the pericæsoophageal tissues. In the event of the so-called 'æsophagotomy tube' not being used, care must be taken in the insertion of the feeding tube that it does not make its way into the soft tissues instead of into the æsophagus. Solis-Cohen<sup>1</sup> quotes an instance which came under his observation, where a rigid stomach tube had been passed. Instead of finding its way into the gullet, it went down into the mediastinum. The accident was undiscovered until after the death of the patient on the following day.

The remaining operations have been performed too rarely to admit of any precise details being laid down as to their execution. They have been limited so far to special circumstances affecting each case, and to the ingenuity of the surgeon operating. Some guidance, however, may be gained, in any subsequent attempts, by a brief and general summary of the steps taken in the few cases recorded, and where the surgeon himself has described the operation performed or made suggestions in reference to it.

**7. Excision of diverticula.**—The preliminary steps for the exposure of the diverticulum are the same as those given for the performance of external æsophagotomy. The pouch is then freed from all connections with surrounding parts, and its neck or junction with the gullet carefully traced. The severance of the sac from the main channel may be effected in one of two ways. It may be cut through, the edges of the mucous membrane of the gullet being then stitched together, as successfully performed by von Bergmann,<sup>2</sup> or the whole thickness of the æsoophageal wall united, as also successfully accomplished by Butlin.<sup>3</sup> Instead of cutting the neck of the sac, it may be secured by two ligatures placed apart, and division effected by the thermo-cautery applied between them. Kocher<sup>4</sup> successfully treated two cases by this method. The treatment of the external wound will probably depend upon the surgeons' individual feelings with regard to the wisdom of

<sup>1</sup> *International Encyclopædia of Surgery*, vol. vi. p. 37.

<sup>2</sup> *Archiv für Klin. Chir.* Bd. xliii. Heft i. p. 1.

<sup>3</sup> *Trans. Med.-Chir. Soc. Lond.* 1893, vol. lxxvi. p. 269.

<sup>4</sup> Solis-Cohen, *Annual of the Universal Medical Sciences*, 1893, vol. v. F—33.

completely closing it or not. Both von Bergmann and Kocher partially closed, stuffing the remaining part with iodoform gauze. The after treatment of these cases will be pretty much a matter for the judgment of the surgeon. It would seem advisable, however, to nourish, if possible, entirely by the rectum. In von Bergmann's case the patient was given water immediately after the operation. On the sixth day milk escaped from the wound. A small fistula resulted, but it was subsequently closed by means of the actual cautery.

8. **Œsophagoplasty.**—Von Hacker<sup>1</sup> has described an operation for the reconstruction of the canal after complete resection of a portion of the Œsophagus for carcinoma. The operation is performed in two stages. After excision of the part, two flaps of skin are raised on each side; these are carried backwards, and united above and below to the cut ends of the Œsophagus. This constitutes the first stage. The second consists of detaching these flaps from their bases and folding them over so as to complete the canal. The stitching is completed around the Œsophagus above and below, and they are united together down the median line. Von Hacker completed the first stage in a patient aged 66 years, but before reaching the second—which is recommended to be performed some two or three weeks later—the patient died of heart failure. Poulsen, who has also performed the operation, was more successful, being able to complete both stages of the operation. The wound healed, leaving only a slight defect below from a circumscribed gangrene of the lower angle of the flaps. The patient, however, succumbed later to pneumonia. In von Hacker's paper there are diagrams of the operation which better elucidate the steps in its performance.

9. **Œsophagectomy.**—The performance of this operation in the neck involves, in the first place, the free exposure of the gullet by the same incision as already given for external Œsophagotomy; and, in the second, the freeing of that portion of the implicated gullet from the parts around, and its excision. The lower end of the canal is then brought out at the external wound, and secured there by stitches to the skin. The chief difficulties of the operation are connected with the excision of

<sup>1</sup> *Centralblatt für Chirurgie*, 1891, No. 7, p. 121.

the affected part, and its greatest dangers are in shock and subsequent septic mischief about the wound.

Endothoracic resection has been proposed by J. Nassiloff,<sup>1</sup> and the directions for the operation as quoted by Solis-Cohen are the following: 'An incision through all the soft tissues is made parallel to the internal border of the scapula, seven to nine centimeters from the line of the spinous processes. Two other incisions are made at the two extremities of the first one. The flap being detached, four ribs are resected one after the other. The pleura is carefully separated from the ribs, and entrance is thus made at the posterior mediastinum. The œsophagus is now to be isolated, an œsophageal sound being introduced first if desired or if required, and raised on a soft hook. The œsophagus is secured by ligatures placed above the neoplasm and below it, the requisite portion is resected, and the ends of the gullet united by suture after the method of Czerny. If the neoplasm is very extensive it is proposed to simply cut the œsophagus and unite its inferior extremity to the skin by suture. The final step of the operation consists in re-covering the wound with the flap of soft tissues.

<sup>1</sup> *Annual of the Universal Medical Sciences*, 1889, vol. iv. G—38.



PART II  
*THE STOMACH*

---

CHAPTER XVII

SURGICAL ANATOMY AND PHYSIOLOGY

**Surgical Anatomy.**—Unlike the œsophagus, which maintains a fixed position, the stomach varies somewhat in its relations according to its degree of distension. The most fixed point is at its junction with the œsophagus; and where, by its other extremity, it becomes continuous with the bowel, it is only loosely secured by the lesser or gastro-hepatic omentum. This same fold of membrane extends along the upper or lesser curvature of the viscus, and, passing to be attached to the liver above, tends to hold, as by a sling, all that part of the organ to the right of the œsophageal opening. The left extremity is further secured by two other folds of membrane. One, the gastro-phrenic ligament, passes up to the diaphragm; while the other, the gastro-splenic ligament, connects it with the spleen. The lower or greater curvature has passing from it downwards the great omentum. This latter, being in its normal condition unattached below, allows of considerable freedom of movement of the dependent portion of the stomach.

*External relations.*—The cardiac orifice of the stomach corresponds posteriorly to a point slightly to the left and below the ninth dorsal spine, and anteriorly to a point just below the junction of the seventh costal cartilage with the sternum on the left side. The pylorus corresponds to a point close to the extremity of the eighth rib on the right side. When distended, the stomach comes in contact with the

abdominal parietes about two inches below the ensiform cartilage. It occupies the left hypochondriac and epigastric regions, encroaching slightly upon the right hypochondrium.

*Deep relations.*—The pylorus and the upper part of the anterior surface are overlapped by the liver, the latter region coming in contact also with the diaphragm, while the former touches in some cases the neck of the gall bladder. Posteriorly the stomach rests upon the pancreas, the large abdominal vessels, and the solar plexus, the membranous transverse meso-colon intervening. By its left extremity it is in contact with the spleen, and close to its lower or greater curvature courses the transverse colon.

*Variations in position.*—The comparative looseness of the connections of the stomach renders it liable to considerable alterations in its position from various causes. In the normal state this varies during the process of digestion. When distended it rotates about its transverse axis, the greater curvature being raised to the front, while the anterior surface is made to look forwards and upwards. In this condition the stomach comes in contact with the parietes. When empty and contracted, it lies back on the pancreas, giving rise to the hollow in the epigastric region of the parietes called the *pit of the stomach*.

In certain abnormal or diseased conditions, the position of the stomach undergoes considerable alteration. Thus distension of the chest with fluid will depress the viscus, while a similar condition of the abdominal cavity will press it upwards. It may also be caused to occupy a lower position by being dragged down by an omental hernia; or pressed down by tight lacing. Disease of the organ itself will produce variations. Thus tumour of the pylorus may cause that part to sink considerably below its normal position, and obstruction at the same situation will so increase the dimensions of the stomach that it will occupy an extensively increased area.

*Structure.*—The walls of the stomach are composed of four layers intermediate in thickness between those of the oesophagus and the intestines: an external serous coat consisting of peritoneum, an internal mucous lining, and an intermediate muscular coat; between the mucous membrane and the muscle is a distinct layer of areolar tissue. Lining the



surface of the mucous membrane is a single layer of columnar epithelium; and located in the membrane are the secretory glands of the stomach. These latter are of two kinds. One kind is situated mostly at the pyloric end, and consist of glands lined throughout by an extension of the surface columnar epithelium. The other kind, the so-called 'peptic glands,' are lined with columnar epithelium near the surface, but towards their deeper parts the cells assume more of a spheroidal character. The mucous membrane is thinnest in the large cul-de-sac and thickest in the pyloric region. It moves freely on the muscular layer owing to the looseness of the intervening submucous areolar tissue. Hence, when in a contracted condition, it assumes numerous folds, which become obliterated on distension of the organ.

The stomach receives its arterial supply from the three branches of the coeliac axis; the greater cul-de-sac and cardiac region being supplied from the splenic and gastric branches, and the pyloric region from the hepatic. The main trunks pass round the greater and lesser curvatures between the layers of the two omenta, and from them branches ramify through the coats of the stomach, finally ending in a dense capillary network around the secreting tubules. The veins which arise from this network eventually empty into the splenic, superior mesenteric, and portal veins. The lymphatics, which form a dense network in the mucous membrane, surrounding alike the glands and the blood vessels, end by traversing the lymphatic glands which exist along both curvatures of the stomach. The nerve supply is from the cerebro-spinal and sympathetic systems. In the former it is through the pneumogastrics, the left being distributed to the anterior surface, and the right to the posterior; in the latter it is through the solar plexus. In addition there are plexuses of nerves and ganglia contained within the visceral walls.

**Physiology.**—The functions of the stomach are twofold—(1) digestion, (2) motion.

The digestive properties consist in the conversion of nitrogenous or albuminous food into chyme; oleaginous and starchy materials being uninfluenced. This action is effected conjointly by a ferment called pepsin and by hydrochloric

acid; these agents, together with some chlorides and phosphates and a large proportion of water, constitute the gastric juice.

The movements of the stomach, brought about by the contraction of its muscular coat, entail in the first place a thorough mixing of the ingested material with the gastric secretion; and in the second its propulsion from the stomach into the duodenum. The food as it enters the stomach passes through the relaxed or dilated cardiac orifice; it is then compressed by the contraction of the gastric parietes, and prevented from passing into the duodenum by closure of the pyloric sphincter, and from regurgitation into the œsophagus by recontraction of the cardiac orifice. The peristaltic action which sets in, besides serving more efficiently to aid digestion, causes, according to Brinton, a peculiar circulation of the contents of the stomach, whereby the digested materials take a peripheral course, and are finally propelled through the relaxed pyloric orifice into the duodenum. The central undigested portions, if not capable of digestion, follow as the residual products, the pyloric sphincter dilating sufficiently to admit of their passage.

Various circumstances affect the normal process of digestion. In some instances these are connected with certain physical causes, in others they are dependent upon the nature of the food taken, and a third class are associated with various nerve influences. Digestion is impeded when the temperature of the contents of the stomach rises a few degrees above 100° F., or sinks a few below it. Thus the ingestion of too much ice or a large quantity of cold water is liable to retard the action of the gastric juice. Again, any lack in the proper movements of the stomach, whereby its contents fail to become well mixed with the gastric secretion, hinders digestion; and, lastly, any hindrance to a proper removal of the already digested material, such as arises in cases of pyloric obstruction, tends to a like detrimental result. With regard to the nature of the foods taken, certain substances appear to be more easily or more rapidly digested than others. Thus, as the result of some of Beaumont's<sup>1</sup> researches, it would seem that the flesh of wild

<sup>1</sup> *Principles of Human Physiology*, Carpenter, 7th edit. p. 134.

animals is more easily digested than that of those of a more domesticated kind. And, further, that of these latter, beef is more digestible than mutton, and mutton than either veal or pork. Fowls are not so digestible as turkey; this latter, with the exception of venison, being one of the most digestible of animal foods. The time taken for the complete digestion of a meal varies between three and four hours. Among other circumstances which may be said to affect the process of gastric digestion are the general state of bodily health, the state of the mind, the amount of exercise before and after a meal, the time since the last meal, and the quantity and quality of the food taken.

---

## CHAPTER XVIII

- METHODS, (1) OF OBTAINING GASTRIC JUICE FOR EXAMINATION.  
(2) FOR DETECTION OF FREE HYDROCHLORIC ACID.  
(3) OF ASCERTAINING THE RATE OF GASTRIC ABSORPTION.  
(4) FOR DETERMINING THE MOTOR POWER OF THE STOMACH.

PHYSICAL EXAMINATION. PALPATION; PERCUSSION;  
AUSCULTATION; INFLATION; GASTROSCOPY; GASTRODIAPHANY

IN view of the increasing clinical importance of a practical knowledge of the constituents of the gastric juice and the movements of the stomach in certain diseases, it would seem advisable to describe these various conditions as they are supposed to exist in the normal state, and the methods adopted for ascertaining them. In what follows, the information has been mostly derived from Ewald's 'Lectures on Diseases of the Stomach' as translated by Saundby.<sup>1</sup>

(1) *Method of obtaining gastric juice for examination.*—In order to obtain the gastric juice it is necessary in the first place to excite its secretion, and in the second to do so by such means as will not materially alter the juice so secreted. For this purpose what is termed a 'test meal' is administered. As an example of this kind of meal, I shall only mention that which goes under the name of 'Ewald's test breakfast.' It

consists of an ordinary dry roll and about three-quarters of a pint of warm water or very weak tea taken upon an empty stomach.

At the expiration of one hour the contents of the stomach are removed in the following way. The stomach tube—which should have a terminal hole and lateral ones, and be made of soft rubber—should be dipped in warm water and then pushed gently backwards to the posterior wall of the pharynx. The patient is then requested to swallow, and by the additional exercise of slight propulsion on the part of the operator, the tube can easily and quickly be introduced. The tube thus within the stomach, its contents may be extracted in one or more ways, either by suction with a pump, by the use of a compressed elastic ball, which on expansion sucks up the material into it, or by a simple process described by Ewald and known as his ‘method of expression.’ This last consists either in abdominal pressure exercised by the operator, or in active expression on the part of the patient; both methods push the contents of the stomach into the tube, provided only that the former are sufficiently fluid. As pointed out by Ewald, this method should not be tried when there is danger of rupture of an aneurysm, brittle vessels, &c.; and, again, it may fail ‘when the abdominal wall is so relaxed that abdominal pressure cannot be applied, and where the patient has no control over his muscles, and is unable to press when desired to do so, or perhaps make convulsive efforts to cough.’

Einhorn<sup>1</sup> has introduced an apparatus which ‘consists of a small oval vessel ( $1\frac{3}{4}$  ctm. long,  $\frac{3}{4}$  ctm. wide) made of silver; on the top of the same is a large opening with an arch over it; on to this arch a silk thread is tied.’ The patient is made to swallow the ‘bucket’ about an hour after the test breakfast. After an interval of five minutes it is withdrawn, and its contents can then be tested.

The contents of the stomach thus removed are filtered, when a fluid clear as water, but possibly tinged slightly yellow or brown, is obtained as a filtrate. This fluid is strongly acid, and owes its acidity to hydrochloric acid and acid salts.

<sup>1</sup> *New York Medical Record*, 1890, vol. xxxviii. p. 63.

(2) *Method for the detection of free hydrochloric acid.*—*Günzburg's method.*—The test solution consists of

2 grms. phloroglucin  
1 grm. vanillin  
30 grms. absolute alcohol.

'It is not necessary to filter the stomach contents before testing it. One or two drops in a capsule or on a strip of filter paper with the same quantity of the reagent are sufficient. . . . The reaction is always bright red, or, with very small quantities, pale rose colour. The fluid does not change on the instant of adding it; but if the capsule is gently heated over a lamp, so that the fluid does not boil but slowly evaporates, at the border of the evaporated drops a bright red patch or small very fine red streaks appear.' Any excess of heat causes a brown, brownish-yellow, or brownish-red colour to appear. This same method for the detection of hydrochloric acid may be used for obtaining an approximate quantitative estimate of the amount present. 'By successive dilutions of stomach contents giving Günzburg's reaction to  $\frac{1}{3}$ ,  $\frac{1}{5}$ ,  $\frac{1}{10}$ , &c., until the reaction no longer occurs, we can estimate approximately the amount of actually free hydrochloric acid, as the lowest limit is about  $\frac{1}{20}$  per mille. If the red colour, for example, is still obtained with the twentieth dilution, the gastric juice contains 1.0 per mille, or 0.1 per cent. of free hydrochloric acid. But one may make a rough guess at the amount of acid according to the intensity of the red coloration.'

(3) *Method of determining the rate of absorption from the stomach.*—'The absorption by the gastric mucous membrane is proved by means of iodide of potassium. Following Penzold<sup>1</sup> we give small doses, 0.1 grm., in capsules which are carefully wiped so that no iodide of potassium is on the outside, and we determine the moment when the salt first appears in the saliva, by help of its well-known reaction on starch solution. Filter paper is soaked in starch solution, dried, and, after the capsule has been taken, the saliva of the patient is tested with it from time to time, about every five minutes.

<sup>1</sup> Penzold and Faber, 'Resorptionsfähigkeit des menschlichen Magens,' *Berliner klin. Wochenschrift* 1882, No. 21, p. 313.

On the addition of fuming nitric acid we can recognise at once, by the occurrence of the blue colour, the appearance of iodine in the saliva. As a rule it takes place in about ten to fifteen minutes. But when absorption from the stomach is delayed, the reaction may appear much later, from half an hour to an hour or more. . . . When absorption is delayed until one or one and a half hour after eating, it is distinctly pathological.'

(4) *Method for determining the motor power of the stomach.*

The object of this investigation is to ascertain the rapidity with which substances taken into the stomach are transmitted by it into the duodenum. This has been approximately effected by the administration of salol, a substance which is not acted upon by the gastric juices, but becomes decomposed when under the influence of the pancreatic secretion. Salol splits up into salicylic acid, phenol, and the conversion product of salicylic acid, salicyluric acid. 'Under normal conditions, salicyluric acid appears in the urine forty to sixty or at latest seventy-five minutes after one gramme of salol has been taken, which is best given during digestion—longer delay indicates slowing of the transfer into the intestine. Salol is a tasteless white powder, and is easily taken. It may be ordered in capsules, or employed in the form of keratin pills, but sometimes these pass undissolved through the bowel, and such pills may easily remain for varying and abnormal lengths of time entangled in folds of the gastric mucous membrane. The advantage of salol is that it mixes intimately with the stomach contents, and certainly accompanies its general movements. Salicyluric acid is easily recognised in the urine on the addition of neutral ferric chloride solution, which produces a violet colour. To detect the first traces, the urine is acidulated with hydrochloric acid and shaken with ether; the salicyluric acid is taken up by the ether and can easily be detected in the ether residue. More simple and no less certain is the plan of dipping a piece of filter paper into the urine and then letting a drop of ferric chloride fall on it. The edge of the drop becomes violet in the presence of the merest trace of salicyluric acid.' In addition to the time at which the acid first appears in the urine, after administration of the salol, there is also the time during which it lasts. In healthy persons its excretion continues for twenty-four hours, while in patients with some impairment

of the motor function of the stomach this may be protracted for forty-eight hours or longer.

In giving the above methods I have merely selected those which seemed simplest, surest, and sufficient for the more limited demands of a work whose chief aim is to deal with the surgical aspects of the subject. The reader therefore is referred to the first of Ewald's Lectures, from which the above abstracts have been taken, for a more detailed description of the methods here briefly given : for a fuller criticism of such discrepancies as may arise in connection with them ; and for an account of various methods for the detection and analysis of the other constituents of gastric juice and gastric digestion.

**Physical examination.**—There remain certain other means for ascertaining the state of the stomach—the so-called physical methods of examination. These are : palpation, percussion, auscultation, inflation, gastroscopy, and gastrodia-phany.

*Palpation.*—To examine the stomach through the parietes by means of the hand, considerable care is required to avoid throwing the abdominal muscles and particularly the recti into contraction. If the tips of the fingers are used, or if the hand be applied cold, a reflex spasm of the muscles is almost certain to be induced.

The patient, lying in the recumbent position, with the knees drawn up and the chest raised, should be enjoined to voluntarily resist any contraction of the abdominal muscles. The palm of the hand and the entire palmar aspect of the fingers, previously warmed if necessary, should be placed flat on the abdomen. Then by a rotatory movement of the hand, coupled with gentle and gradual pressure exercised by the flexor surfaces of the terminal phalanges, both a superficial and deep examination can be made. In certain cases further information may be gained by palpating in the knee elbow position. In all cases palpation is more efficiently carried out when the patient is under an anæsthetic. Vigorous palpation will elicit sounds of splashing when conditions exist favourable for its production.

*Percussion.*—As a method of examination percussion, as ordinarily practised, is of little diagnostic value. A tympanic note may be heard, but in cases where the colon overlaps or is situated just below the stomach, it is not possible to

distinguish where the one ends and the other begins. In a paper by R. A. Fleming<sup>1</sup> an attempt is made to show that by the combined methods of auscultation and percussion it is possible to delineate with a considerable degree of accuracy the lower boundary of the stomach. The stethoscope is applied to the stomach 'in what has been called Traube's area, i.e. to the left of the mid-abdominal line and between the free edge of the left lobe of the liver and the costal margin—where, in most cases, the stomach is in direct contact with the abdominal wall. But if some suspicion exists as to whether colon or stomach underlies this area, the stethoscope may be placed between the left border of the xiphoid cartilage and the costal margin. This of necessity means auscultating through the thin edge of the left lobe of the liver, but, notwithstanding, the sound produced by the percussing finger is very clearly conveyed to the ear. . . . In all the cases tested, I used both the finger and also an ivory pleximeter and percussed with one finger. A note, probably stomach, was obtained by percussing close to the stethoscope; and then by commencing (on the left side of the abdomen) below the umbilicus, or, in cases of suspected dilatation, as low as the symphysis, the stomach note could be at once detected by the auscultating ear whenever the stroke was made over it, even though the colon overlapped. Great care was taken to percuss vertically downwards, and the patient was always in the recumbent posture.'

*Auscultation.*—Apart from its use in conjunction with percussion, auscultation is of little value as a diagnostic means. Unlike the œsophagus, there is no constant or typical sound produced by movements of the contents of the stomach, and such sound as has been noted—that is, that produced by the passage of food through the cardiac orifice into the stomach—is both uncertain and wanting in constancy of character. In cases, however, of serious obstruction at the cardiac orifice, there will be complete absence of any sound.

*Inflation or Distension.*—In cases where it is necessary to ascertain the size and position of the stomach, the viscus is inflated with gas. There are different ways of doing this. One of the simplest is to insert the stomach tube, attach to its free end the bellows of an ordinary spray apparatus, and

<sup>1</sup> *Edinburgh Hospital Reports*, 1893, vol. i. p. 69.



then pump in air. When the patient, or the stomach, can no longer endure any increase in the distension, the air will escape by the side of the tube, and this it will usually do more readily than pass into the duodenum. The method of inflation alone does not, however, entirely get over the difficulty of distinguishing a dilated stomach filled with air, from the transverse colon distended with gas. The following method, adopted by Dehio and recommended by Ewald,<sup>1</sup> appears to obviate this difficulty. 'The patient must drink at intervals four quarter-litres of water, so that he takes a whole litre in four portions. If after each quarter-litre has been taken the limits between the lower semicircular dulness and the distended transverse colon be clearly ascertained by means of percussion, these limits in a healthy patient, when he is in a standing position, may be seen, in proportion to the fluid poured into the stomach, to advance downwards to about a few centimetres above the umbilicus, but never below it. When the patient is lying down, tympanitic resonance, caused by the air which is swallowed at the same time as the water, takes the place of the dulness, and this prompt change of sound is a certain proof that it is the stomach and not the bowel.'

In marked cases of dilatation following upon obstruction at the pylorus, it is sometimes sufficient to pour in through a stomach tube some pints of warm water. The extreme emaciation which usually accompanies these conditions admits of the distension of the stomach, and the descent of its greater curvature being visibly observed and easily determined by palpation.

*Gastroscoy.*—With regard to this method of investigation, all that can be said is that it has been attempted. Leiter has constructed a gastroscope, and Mikulicz<sup>2</sup> has employed it with some measure of success.

*Gastrodiaphany.*—Like the above, this method of examination has received up to the present but a very limited trial. Its use has, however, been attended with success, and Solis-Cohen<sup>3</sup> speaks of having used the gastrodiaphane 'with satisfaction.'

<sup>1</sup> *Lectures on Diseases of the Stomach*, vol. ii., New Sydenham Society, 1892.

<sup>2</sup> *Wiener med. Wochenschrift*, 1883, vol. xxxiii. p. 748.

<sup>3</sup> *Annual of the Universal Medical Sciences*, 1893, vol. i. C—9.

This author thus describes Einhorn's method of translumination or gastrodiaphany: 'The patient, fasting, drinks one or two glassfuls of water, and the apparatus (consisting of an electric lamp, attached to a soft-rubber tube containing the connecting wires), lubricated with glycerine, is then inserted (or rather swallowed). In a dark room, the patient being either in a standing or lying position, a reddish luminous zone upon the abdomen indicates the outline and position of the stomach. Thickening of the anterior wall, as by neoplasm, obscures or prevents the illumination. The method is especially valuable in delimiting the lesser curvature in gastrectasia and gastroptosis. Hering and Reichmann's lamp, described by Renvers and Pariser at the Berlin Medical Society, appears to be larger than that of Einhorn, and is covered by a small glass vase filled with water. They wash out the stomach and introduce one and a half to two litres of water before inserting the lamp. The patient must be standing, as the full stomach falls away from the abdominal wall. A case of carcinoma was thus diagnosed and confirmed by section. The tumour appeared as a dark spot in a light field.'

---

## CHAPTER XIX

### INJURIES: CONTUSION, TRAUMATIC RUPTURE, TRAUMATIC PERFORATION, GUNSHOT WOUND

**Contusions.**—Cases of uncomplicated contusions of the stomach are rare. It is more usual for the injury which produces the contusion to inflict at the same time some graver lesion elsewhere, with the result that the symptoms which might be sufficient to indicate the stomach mischief are more than obscured by the severity of those arising from the damage to other parts.

When the injury to the stomach wall has been sufficiently severe, some after effects may result. Thus either an acute or chronic inflammatory process may be set up, the patient suffering from symptoms of an acute or chronic gastritis. While the symptoms of these affections will be best learnt by a reference to the same conditions as they arise from other causes

and are fully described in books on medicine, the surgeon should be familiar with a few of the more prominent manifestations. In acute gastritis there is pain in the epigastrium, frequently of an intermittent character and augmented by the ingestion of food. Pressure with the hand in the left hypochondrium may cause a feeling of tenderness; and deep inspiration may also cause distress from pressure of the diaphragm downwards. Various febrile disturbances may be present, such as rise of temperature, rapid pulse, thirst, scanty urine, nausea, and constipation.

When the inflammation assumes a more chronic character, dyspeptic symptoms will arise. In two cases quoted by Poland<sup>1</sup> an abscess formed which subsequently burst and gave rise to a fistula.

It must be remembered that it is not always easy to distinguish between symptoms arising from inflammation of the peritoneum and those due to a like condition of the stomach.

**Treatment.**—At whatever stage of the affection, whether early—that is, shortly after the accident—or later when inflammatory mischief has become manifest, rest must be procured for the injured or diseased organ. Strength must be sustained as much as possible by the administration of nutrient enemata; and when it is found necessary to give food by the mouth, this should be of a kind to entail as little functional activity of the organ as possible. The foods chosen should be easily digestible, non-irritant, nutritious, and given in small quantities frequently.

**Ruptures.**—It is possible that as an accident contusion is more frequent than rupture, although, post mortem, ruptures are certainly more often seen. Like contusions, however, the injury is very frequently associated with graver lesions. In the only case which I have seen, that of a boy admitted under my care in the Victoria Infirmary, the spleen was also ruptured. In four cases recorded separately by Poland,<sup>2</sup> Erichsen,<sup>3</sup> Pollock,<sup>4</sup> and Clayton,<sup>5</sup> a similar complication

<sup>1</sup> *Guy's Hospital Reports*, 3rd series, vol. iv. p. 132.

<sup>2</sup> *Ibid.*

<sup>3</sup> *Science and Art of Surgery*, 9th edit. vol. i. p. 877.

<sup>4</sup> *Holmes's System of Surgery*, 3rd edit. vol. i. p. 876.

<sup>5</sup> *Brit. Med. Journ.* 1894, vol. i. p. 634.

existed. The liver is not infrequently injured. In a case reported by Morris,<sup>1</sup> the left lobe was displaced into the left pleural cavity, through a rent in the diaphragm. In Poland's case also, the liver was involved. In a table of eleven cases collected by Grant Andrew,<sup>2</sup> reference is made to a case of Buist's where the spleen was ruptured; and to one by Andrew Wilson where the liver was similarly involved. When the close anatomical relations of these two organs, the liver and the spleen, to the stomach is remembered, it will be evident that in all severe ruptures one or the other or both of these viscera may be implicated. Minor<sup>3</sup> records a case where, in addition to a rupture of the stomach which involved the lesser curvature and extended in the long axis of the organ, a rupture of the ileum was also found.

The nature of the rupture varies. In some cases only the peritoneal coat is severed, in others only the mucous, while in all cases of any severity the entire wall is divided. The lesion may be located in any part and may be of any extent, and, further, there may be more than one lesion. In the case reported by Clayton, 'the mucous membrane was seen to be ruptured in two places, the one being on the anterior surface midway between the cardiac and pyloric extremities, of a somewhat irregular star-shaped area one inch in diameter, the mucous membrane alone being stripped from the underlying muscular coat; the other was situated on the posterior wall immediately opposite to the one on the anterior wall, and resembling it in size and in its limitation to the mucous coat.' In some very severe instances the organ has been torn completely through. In such cases the injuries appear to involve most frequently the pyloric region. The extent of the lesion is largely determined by the amount of distension at the time of the injury.

Traumatic ruptures result either from a severe blow in the epigastric and left hypochondriac regions, or, as is more frequently the case, from a tight squeeze; or from a crush

<sup>1</sup> *International Encyclopædia of Surgery*, vol. v. p. 869.

<sup>2</sup> *Trans. Path. and Clin. Soc. Glasgow*, 1895, vol. v. p. 38.

<sup>3</sup> *New York Med. Journ.* 1887, p. 360.

such as is produced by the passage of a wheel of a heavy vehicle over the body.

**Symptoms.**—An injury sufficiently severe to cause a complete rupture of the stomach gives rise to symptoms of more or less profound collapse. Great pain is complained of in the upper part of the abdomen, coupled with vomiting in which the ejecta may or may not contain blood. If death does not ensue shortly after the accident, some temporary rallying may take place; but the patient, after a variable period of restlessness and great suffering, sinks again into a state of collapse terminating in death.

In the less severe forms of injury, where the rent may only have involved the serous or mucous coat, or the complete rupture has been too slight to admit of any escape of the gastric contents, the symptoms will be less marked. The primary collapse may be comparatively slight, and the patient, when once well out of the immediate shock, may make an uninterrupted recovery. It is, however, in these milder forms of injury that secondary and later complications may sometimes arise. Thus, in a case recorded by Limont and Page,<sup>1</sup> cicatricial contraction resulted in the region of the pylorus after a blow received seventeen years previously. In other instances an abscess may form at the seat of lesion and, bursting externally, give rise to a gastric fistula. Coutaret<sup>2</sup> describes a condition which he terms 'entasis,' and which is due to the 'partial rupture or detachment of the peritoneum, or of the attachment of the stomach, spleen, pancreas, or liver with a circumscribed exudative peritonitis which may eventuate in recovery or in an abscess which opens externally or into a viscus. . . . Digestion is impaired slowly, and emaciation is usually insensible. The characteristic sign is impossibility of sustained physical exertion.' If no abscess or other untoward symptom shows itself, recovery may be expected in from six to eighteen months.

**Treatment.**—The profound shock which usually exists in severe cases, renders out of the question all considerations other than those directed to the patient's collapsed condition. However strong may be the evidences of rupture

<sup>1</sup> *Lancet*, 1892, vol. ii. p. 84; also *Brit. Med. Journ.* 1893, vol. ii. p. 427.

<sup>2</sup> *Annual of the Universal Medical Sciences*, 1892, vol. i. C—9.

of the stomach, it would only be cutting the last thread of life to venture upon anything operative at this critical period. Every endeavour should therefore be made to rally the patient. Warmth should be freely applied all over the body, and warm brandy enemata administered. So soon as there is distinct indication of the patient's strength increasing, as shown by a better pulse, there is nothing but harm to be gained by delaying an operation. The cases are by far too few and too varying to admit of any definite statement being made as to what should be done, we only know that in a bad case of rupture death will certainly, in most if not in all instances, ensue; while we equally know that to open the abdominal cavity, properly cleanse it, and stitch up any rent discoverable in the gastric wall, is neither a grave nor a long operation, and one which follows the same lines in which ruptures in other parts of the alimentary canal have been successfully treated. But for the frequency of severe injury to other parts, there is no reason why an early operation, performed as above indicated, should not prove as successful in rupture from accident as in perforation from disease. Before the administration of the anæsthetic a hypodermic of morphia should be given to prevent further shock.

As regards later complications, Limont's case of cicatricial contraction of the pylorus was successfully treated by pyloroplasty. Page exhibited the patient at the annual meeting of the British Medical Association, at Newcastle, in 1893. He was then, seventeen months after the operation, perfectly well and at work. The treatment of a gastric fistula will largely depend upon its size and the physical inconvenience to which it gives rise. When the orifice is small it may be possible to occlude it by a plastic operation. Pollock<sup>1</sup> quotes a case by Mipdeldorpf in which the latter operated by bringing up a flap of skin from the lower extremity of the opening, and fixing it to the edges of the orifice by sutures. When, however, such endeavours fail or are not feasible, some more radical measure must be adopted. The abdomen should be opened in the region of the fistula, the latter excised, and the stomach wound completely occluded by sutures; it is then allowed to

<sup>1</sup> Holmes's *System of Surgery*, 3rd edit. vol. i. p. 900.

drop into the abdominal cavity, and the operation completed by uniting the edges of the parietal wound.

CASE XLV.—*Rupture of the stomach and spleen. Death.*

A boy aged 17 was admitted into the Victoria Infirmary, Glasgow, under my care, at 10 A.M. on December 10, 1892. He had received a severe squeeze in the upper part of his abdomen, being jammed between the wall and a cart. When admitted, he was in a collapsed condition, complaining of pain in the lower part of his abdomen, and of great difficulty in breathing. He was most distressed about his respiration, constantly turning from side to side and crying out to be relieved. His eyes had a sunken appearance, and his face generally an ashy-grey, rather pinched aspect. His hands were cold and somewhat livid, and his pulse small, feeble, and rapid—132. Any manipulation of the abdomen caused pain and put the muscles into rigid contraction. There was no abrasion nor bruising of the skin to be seen. At 6 P.M. he was much weaker, his pulse being very small and hardly perceptible. He craved to be made better, but seemed freer from pain. The abdomen was now quite flaccid and had a livid appearance. Manipulation caused no pain, and the impression conveyed was that there was a quantity of blood within the peritoneal cavity. At 6.30 P.M. extreme collapse set in, and he rapidly sank. While in the infirmary he did not vomit, but it was stated that he had done so prior to admission. It was not ascertained whether or not the ejecta contained blood. At the post mortem the peritoneal cavity was found filled with blood. Both the spleen and the stomach were found to have been ruptured. (A. Ernest Maylard, 'Clinical Reports,' 1892, Ward III. No. 199.)

**Penetrating wounds.**—As the result of a stab from a knife, foil, or sword, the stomach may be punctured. The gravity of the penetration depends upon the direction of the wound, its size, and the condition of the stomach at the time. Thus a small wound, or one which is oblique in its transfixion of the gastric wall, inflicted upon an undistended organ will be far less severe than where the opposite conditions exist. The contraction of the stomach wall is capable of occluding a small opening, and still more so when it is oblique, so that any escape of material from the stomach cavity is prevented. With the exception of the escape of foods &c. into the peritoneal cavity, the only other complication of any gravity is hæmorrhage, the bleeding sometimes being excessively free from the wound in the wall of the stomach.

**Symptoms.**—The most convincing proof that the stomach has been penetrated is the escape of its contents through the external abdominal wound. This, however, is unfortunately

exceptional, and the diagnosis has to be often made on much less certain evidence. The position of the external wound and the nature of the weapon producing the injury should substantially assist in arriving at a correct conclusion, especially when coupled with vomiting and the presence of blood in the vomit. There is usually at the outset considerable shock, combined with an expression of great anxiety, cold sweats, and pain of an unremitting character radiating from the seat of injury. At a later stage, in cases of escape of the gastric contents into the peritoneal cavity, symptoms of acute peritonitis will arise.

Repetto<sup>1</sup> reports two cases of stab wounds. In one the patient, a man aged 33, suffered from shock, and vomited food, blood, and bile. Laparotomy was performed, and, after considerable search, a small cut less than half an inch was found in the stomach wall. Eight Czerny-Lembert sutures were used, and the man made a good recovery. In the second case the patient, a man aged 27 years, died. At the post mortem both the anterior and posterior surfaces of the stomach were found to have been wounded. Beck<sup>2</sup> records the case of a man aged 17 who was stabbed in the upper and left part of the abdomen. He was shortly after seized with hiccough and vomiting of blood. After opening the peritoneal cavity, a wound in the stomach 2.5 cm. long was found and stitched up. The abdomen was washed out with 0.6 per cent. salt solution. A good recovery ensued.

**Treatment.**—What has been already stated in connection with the treatment of cases of ruptured stomach is equally applicable here. The early shock should be first dealt with, and then, so soon as the patient seems to have regained sufficient strength, no delay should be exercised in opening the abdomen, cleansing its cavity, suturing the stomach wound, and reuniting the abdominal incision. In those cases where the symptoms are slight and it is believed that the wound is small, the utmost rest should be enjoined. If nature is to effect an unassisted cure, it will be by adhesion of the wound to neighbouring parts, so that everything must be done to keep the patient quiet in bed, and the stomach free from any functional

<sup>1</sup> *Centralblatt für Chirurgie*, 1893, No. 38, p. 832.

<sup>2</sup> *Brit. Med. Journ. Epitome*, 1894, vol. ii. p. 82.



activity. To relieve pain a hypodermic of morphia may be given, or a few drops of laudanum may be administered with a nutrient or stimulating enema. Nothing should be given by the mouth for at least forty-eight hours; and if thirst be very troublesome it will be alleviated by rectal injections of warm water.

**Gunshot wounds.**—It is comparatively rarely that this form of penetrating wound comes under the observation of the civil surgeon. The fact, however, that an occasional case crops up in our general hospitals renders it necessary to briefly refer to the subject.

The nature of the wound, although of a penetrating character, differs somewhat from those just discussed. A bullet does not cause a clean-cut wound, but in its transit destroys a certain amount of tissue. Hence, if it pass through the gastric parietes into the cavity of the stomach, it leaves a track which is much more liable to admit of the escape of the contents of the stomach than in the case of a clean incised wound.

The symptoms connected with a gunshot wound are very much like those already described in connection with a penetrating one. The hæmorrhage from the stomach is sometimes severe, and the blood-stained condition of the vomit is the best evidence that that viscus or possibly the duodenum has been penetrated.

The danger of extravasation into the peritoneal cavity is so great in this class of wounds, that surgeons are now generally of opinion that an exploratory laparotomy should not be delayed. The injury, according to all military records, is excessively fatal when allowed to pass untreated; so that where these cases happen in civil practice, we should not delay in using the comparatively perfect means we have at our disposal in our general hospitals. The wound in the stomach, or perchance in the duodenum, should be carefully sought for, and when found accurately sutured. The abdominal cavity should be thoroughly cleansed from any foreign or escaped material by freely flushing it with warm water or a warm solution of some diluted antiseptic; or if the extravasated material be but slight, it may be simply wiped away. As in the case of other penetrating wounds, fistulæ have been known

to result from those due to gunshot injury. The case of Alexis St. Martin is too well known to need anything further than a passing reference. Whether or not the question of treatment arose in his case it is not possible to say. But in any case where it may be entertained, the remarks above in connection with the treatment of penetrating wounds will equally apply.

CASE XLVI.—*Pistol-shot wound of the stomach: suture of wounds. Recovery.*

C. H. A., aged 18, was admitted on March 26, 1893, in the Liverpool Northern Hospital. He stated that while cleaning a pistol it suddenly went off. When first seen he was very restless, calling out with pain, and asking for a drink every few minutes. His lips were very pallid, his skin covered with a clammy perspiration, and his pulse extremely bad—weak, intermitting, and irregular. Breathing was shallow, and pain prevented his drawing a deep breath. The abdominal walls were rigid, but there was no dulness. He vomited a quantity of blood before reaching the hospital. The wound in the abdominal wall was a small hole with blackened edges, situated to the left of the epigastric region and immediately below the costal arch. Laparotomy was performed. The wound of entrance into the stomach was at once seen on the anterior wall about two inches from the pylorus and midway between the two borders, and the wound of exit was found on the posterior wall a little nearer the upper than the lower border. The orifices were freshened, and closed by Lembert's sutures. The bullet could not be detected posteriorly. The abdominal cavity was flushed with boiled water. The boy made a rapid recovery. The accident had taken place when the stomach was empty, the boy having taken no solid food for about six hours. (Arthur H. Wilson, 'Brit. Med. Journ.' 1894, vol. i. p. 63.)

Tiffany<sup>1</sup> records a successful case of suture where the bullet had passed through the stomach, thus causing two apertures. The wound of exit was under the spleen in the greater curvature of the stomach.

---

## CHAPTER XX

### FOREIGN BODIES. GASTROLITHS. HAIR CONCRETIONS

**Foreign bodies.**—Solid substances incapable of being digested, or only acted upon to a limited extent by the gastric

<sup>1</sup> *American Journal of the Medical Sciences*, 1896, vol. cxi. p. 552.

juice, and of such a size and shape as to be impassable, or passable only with difficulty through the pylorus, constitute what may be broadly termed 'foreign bodies in the stomach.' As a more literal meaning of the term, the word 'foreign' also implies substances in the stomach which are abnormal in that situation.

As in the case of the œsophagus, there is no limit to the list of solid substances which may be swallowed, and constitute what are understood by foreign bodies in the stomach. Taken, however, as a class of cases, they are far less frequently met with. They manifest, too, in their symptoms, usually much less urgency and severity; and while œsophageal impactions are almost always associated with symptoms of some kind, it not infrequently happens that a foreign body may remain in the stomach without causing anything but the slightest gastric disturbance.

The causes of a body being detained are to be found in the foreign body itself, and in the stomach. In the former case it is the size of the body, or its size coupled with its shape and consistency; in the latter it is the large size of the cavity in which it is lodged, and the comparatively small constricted orifice through which it is required to pass. It might be to some extent reasonably assumed that what could pass through the cardiac orifice would also pass through the pyloric, and such would doubtless be the case could the body maintain a similar disposition of its axis to that which it had in entering the cavity. A large object, however, is almost certain to change its axis after it has passed through the cardiac aperture, and such an alteration may render it a physical impossibility that it should be able to leave the stomach, by the pylorus. Again, there are some structures which neither from their size nor irregular shape would give rise to trouble, but being sharp pointed are liable to become engaged in the mucous folds and, from the active contractions of the stomach, be driven inextricably into the coats of the viscus.

**Symptoms.**—Considerable variations exist in the symptoms which arise when a body becomes retained in the stomach. At the two extremes we have on the one hand an almost entire absence of symptoms, on the other manifestations of

the most acute suffering and anxiety. Pain, when experienced, varies in its kind and in its intensity, in its locality and in its duration. A determining factor in the patient's sufferings is the nature of the body present. Thus when, for instance, this consists of a solid lump of metal, a sense of weight or oppression is experienced in the epigastric region; when of an irregular or sharp-pointed material, capable of injuring the mucous membrane, pain of an acute character is felt. The pain experienced may be circumscribed or localised, felt in front, at the side, or behind. It may radiate and appear more diffused. In some cases it is increased by taking food, due in all probability to the increased peristaltic action induced by ingestion. In other cases it is diminished, when the explanation seems to be that the distension of the viscus removes temporarily the wall of the stomach from contact with the irritating foreign body. Pressure applied externally sometimes causes pain; and in a similar way respiration, for the diaphragm descends in each inspiration and presses upon the stomach from above. In some instances the pain partakes somewhat of a spasmodic character. At one time free from all feeling of discomfort, at another the patient is seized with pains of excessive acuteness and intensity. Vomiting is not a constant symptom, but when present and the ejecta are tinged with blood, laceration of the mucous membrane is probable.

Besides these local symptoms of pain and occasional vomiting, more generalised symptoms will be present, and these more or less in proportion to the severity of the former. In the severer cases there may be great anxiety, sleeplessness, anorexia, thirst, emaciation, and other conditions dependent upon a disordered digestion and an insufficiency of nourishment. There may be constipation or diarrhœa. In a case reported by Sutton,<sup>1</sup> the presence of an *ascaris lumbricoides* in the stomach gave rise to choleraic symptoms which immediately disappeared on the ejection of the worm. In a very unusual case reported by Richter,<sup>2</sup> the pylorus became obstructed by *sarcinæ ventriculi*, causing the patient's death. In cases of prolonged retention without great severity of the symptoms at

<sup>1</sup> *Lancet*, 1888, vol. i. p. 368.

<sup>2</sup> *Archiv für pathologische Anatomie*, 1887, vol. cvii. p. 198.

the outset, secondary complications may arise. Perforation of the stomach may take place. If no adhesions have previously formed, acute peritonitis will ensue; if, on the other hand, the stomach has become adherent to the abdominal wall, the process of ulceration which is going on may lead either to the formation of an abscess or more directly to a perforation of the skin—in both instances the result would be a gastric fistula. Hashimoto<sup>1</sup> records a case where a tooth-brush had been extracted after fifteen years' retention in the stomach. It had first caused an abscess, which, bursting externally, had left a fistula. Other cases are mentioned by the same surgeon where the foreign body had made its way to more distant parts of the organism, being finally extracted, or escaping by a process of abscess formation and ulceration.

**Diagnosis.**—The most important factor in diagnosis is the history of the case. Without the previous knowledge that a foreign body has been swallowed, it is practically impossible to state from the symptoms the nature of their true cause.

As Poulet<sup>2</sup> very forcibly shows, 'We can scarcely find an authentic case in the entire literature in which the diagnosis has been made in the absence of a history.' Unfortunately the majority of the cases in which this accident is found are either lunatics, drunkards, or children, just such as refuse, or are incapable of giving, the information most needed. With, however, a history, the accompanying symptoms will readily support the truth of the patient's statement, and little doubt will exist in the surgeon's mind that the sufferings experienced are dependent upon the retention in the stomach of a foreign body.

In exceptional cases, and with certain kinds of foreign bodies, it is possible to obtain evidence of their presence in special ways.

In one or two instances the 'body' has been palpated through the abdominal wall. Lowson<sup>3</sup> reports a case in which a lunatic had swallowed a skewer. It was felt projecting below the eighth costal cartilage. Beck<sup>4</sup> also felt externally

<sup>1</sup> *Archiv für klinische Chirurgie*, 1888, vol. xxviii. p. 169.

<sup>2</sup> *Foreign Bodies in Surgery*, vol. i. p. 155.

<sup>3</sup> *Brit. Med. Journ.* 1893, vol. i. p. 116.

<sup>4</sup> *Ibid.* Epitome, 1894, vol. ii. p. 82.

penknives which had been swallowed. It is sometimes possible to strike the substance within the stomach by the passage of an œsophageal sound ; in the case just quoted, this was done.

In a case recorded by Cant,<sup>1</sup> the patient stated that she had swallowed a razor ; the fact was, however, doubted by her friends. Twenty drops of hydrochloric acid were administered. An hour after the stomach was washed out ; the washings were collected, filtered, evaporated down, and redissolved. The presence of iron in large quantity was shown by the Prussian blue test.

Another means of determining the existence of a metallic body in the stomach is by magnetism. Pollailon<sup>2</sup> confirmed a suspicion of the kind in a case where it was believed the patient had swallowed a table-fork. He placed near the epigastrium a delicate magnetic needle, and found that it was distinctly deflected. By another method a powerful electro-magnet was placed close to the abdominal wall. On closing the circuit an arching of the skin was produced, as if a body within the abdomen were being attracted towards the poles. By a third process a suspended electro-magnet oscillated towards the abdomen whenever the current was passed. At the meeting of the Paris Academy of Medicine at which the above case was discussed, Pollailon and Goubaux suggested that by means of inducing vomiting it might be possible to so dilate the cardiac orifice that a metallic substance might be extracted by way of the œsophagus by means of a powerful electro-magnet.

**Prognosis.**—One of four things must happen : (1) the ‘body’ will be ejected through the mouth ; (2) it will pass through the pylorus ; (3) it will remain an indefinite time in the stomach ; (4) it will work its way through the stomach and make its exit somewhere through the skin. Of these, the commonest result most fortunately is the ultimate passage of the body through the pylorus. It need hardly be said that before any opinion can be expressed as to the probable course a foreign body will take, there must first exist an accurate knowledge of the nature of the body swallowed. Given two

<sup>1</sup> *Brit. Med. Journ.* 1893, vol. i. p. 13.

<sup>2</sup> Extract in *Lancet*, 1886, vol. ii. p. 592.

cases, in one of which a fork has been swallowed, and in the other a coin, it would be reasonable to expect that the coin might pass through the pylorus, but it would be very doubtful whether such a course would be taken by the fork.

The two practical questions which the surgeon has to answer are, first, whether there is a chance of the foreign body making its way out of the body *per vias naturales*, with the assistance possibly of some medicinal or dietetic measures; or, second, whether the only chance of removal must be by operation. This naturally leads to the question of treatment.

**Treatment.**—The conservative measures consist in attempting to get the body ejected by the mouth or passed on into the bowel; the operative, in the extraction of the body through an artificial opening made through the abdominal parietes and the stomach wall.

With regard to attempts to remove the 'body' through the mouth, there are comparatively few cases in which it would be wise to induce emesis of a character more frequent and more energetic than that which may possibly exist as a symptom. The nature of the substance will determine the question whether or not the trial should be made. It can easily be understood that to attempt by this means to remove a body which has passed perhaps with difficulty into the stomach, is only likely to court the greater danger of its becoming seriously impacted within the œsophagus.

Endeavours to get the body to take the natural course of exit through the pylorus must entail considerations which affect on the one hand the patient, and on the other the foreign body itself within the stomach. Recumbency should be enforced, and the patient made to lie as much as possible on the right side, in order to place the pyloric orifice in the most dependent position. Any pain, spasms, or gastric irritability should be relieved by the administration of narcotics, preferably opium. The nourishment of the patient forms an essential part of the process of cure. Substances are given which will be likely either to form a mass with the 'body,' and so dilate the pyloric orifice sufficiently to admit of its passing; or to lubricate it, or to entangle it in such a way that in both instances its onward passage will be facilitated. Among the first class are potatoes, constituting the well-known

potato cure; rice, porridge, &c.; among the latter are oils, fats, and thick glutinous drinks. As an example of the nature of entangling the object in some shreddy material may be mentioned a case recorded by Dickson.<sup>1</sup> The patient, a lady, had swallowed a plate of false teeth during the night. She was made to swallow a small amount of oakum and a large number of figs and raisins. The treatment was continued for a week, when she suddenly felt relief, and a few hours after passed the teeth *per anum*. The irregularities of the false teeth were found to have been rendered somewhat smoother by the oakum and bits of the fig, which had become adherent to them. Pisko<sup>2</sup> reports the case of a baby, 11½ months old, in which the potato cure was followed by the evacuation by the bowel of a steel screw that had been swallowed. For several days the infant was fed only on potatoes. A laxative was then given, when the screw, imbedded in fæces, was easily and painlessly passed. Solis-Cohen<sup>3</sup> reports a case in which the same treatment was adopted. After two days an irregularly shaped dental clasper was successfully passed. Beck<sup>4</sup> instances the case of a man who was in the habit of swallowing penknives. Gastrotomy was performed, and the knives successfully removed. He, however, again got into trouble by swallowing two penknives, and on this occasion food with abundant solid residue was given. In eight days one penknife was passed, and seven days later the second came away.

When the foreign body is a metal structure of some kind, and especially if it be composed of iron or steel, the question arises of the possibility of lessening its size by some solvent action. Independently of artificial means, iron or steel undergoes considerable changes due to the action of the gastric juice alone. Numerous instances are now on record and specimens forthcoming to show the marked corrosive action of the normal gastric secretion. A number of knives are exhibited in the museum of Guy's Hospital, London, which were removed from the stomach of a man who for years prior to his death had been in the habit of performing in

<sup>1</sup> *Edinburgh Med. Journ.* 1876, p. 839.

<sup>2</sup> Solis-Cohen, *Annual of the Universal Medical Sciences*, 1892, vol. i. C—17.

<sup>3</sup> *Ibid.*

<sup>4</sup> *Brit. Med. Journ. Epitome*, 1894, vol. ii. p. 82.



this way with the object of making money. It is possible, however, to accelerate this normal action of the gastric juice by administering drinks containing citric or tartaric acid.

Our last resource in treatment is by operation, and surgeons nowadays would prefer to make use of this severe, yet fortunately comparatively safe, procedure, to spending time in trying conservative measures which in most instances must hold out a very doubtful result. The operation of gastrotomy has now been frequently performed for the extraction of foreign bodies, and, so far as the recorded cases are concerned, with almost unbroken success. Bernays<sup>1</sup> gives a table of thirteen cases in which gastrotomy was performed. Only two failed to make a speedy recovery, and in both there were complications which sufficiently explained the reason. Little hesitation therefore need exist in the mind of the surgeon as to the right course of action to adopt when once he is satisfied that there is a poor chance of the foreign body finding a speedy exit by any other means.

I must not conclude the subject of gastric foreign bodies without referring the reader to the exhaustive article upon it by Poulet, in his own work on 'Foreign Bodies in Surgical Practice.' A much more extensive and interesting résumé of the subject will be found there than it has been possible to introduce here.

CASE XLVII.—*The existence of a razor in the stomach.  
Laparotomy. Death from hæmophilia.*

Mrs. S., aged 68, was admitted into the Lincoln County Hospital, having attempted to destroy her life by swallowing a razor. There were no symptoms, and no signs of the razor could at first be detected. Although the patient herself maintained that she had swallowed it, her friends refused to believe this. The Prussian blue test was tried (see above), with the result that the presence of iron in the stomach was confirmed. On the morning of the fifth day after admission, the end of the razor could clearly be felt fixed at the pyloric end of the stomach. On the evening of the same day she vomited and suffered slight pain. On the sixth day gastrotomy was performed. The razor was found lying lengthwise in the stomach, the narrow end in the cardiac region. The woman died, five days after the operation, from hæmorrhagic exhaustion. She was a 'bleeder,' and had lost much blood before the operation. (W. J. Cant, 'Brit. Med. Journ.' 1893, vol. i. p. 13.)

---

<sup>1</sup> *Annals of Surgery*, 1887, vol. v. p. 128.

**Gastroliths and Hair tumours.**—These are two forms of foreign bodies which deserve separate notice. They are of the nature of concretions, and owe their origin and existence to the special conditions under which they are formed.

**Gastroliths.**—Little is known as to the real origin of these bodies. In some cases it would appear that the nucleus is formed of hair, and around this has been built up a structure of vegetable material. In other cases no such definite form of a nucleus is observable. In a case reported by Kooyker,<sup>1</sup> a mass was found in the stomach, twenty-eight ounces in weight, no nucleus was present, and on microscopical examination it was found to be composed of starch granules, plant tissues, cells, and vascular bundles containing chlorophyll. A case of similar nature is referred to by Langenbuch in 1884.

**Hair tumours.**—Tumours composed entirely of hair are more frequently met with than gastroliths. Not a few have now been recorded. Knowsley Thornton<sup>2</sup> in 1886 reported a case in which he had successfully removed a mass of hair weighing two pounds. He refers to a similarly successful case of removal by Professor Schönborn. In this latter instance the hair ball weighed nine or ten ounces. Several other cases are referred to in the remarks that follow. In these, death occurred mostly from peritonitis dependent on ulceration and perforation. The cases quoted are those of Bardamant, Pollock, May, Ritchie, Russell, Inman, and Best. Later a third successful case of gastrotomy for this form of body was recorded by Berg.<sup>3</sup> The tumour weighed about thirty ounces. At a still later date a case is reported by Ballinger.<sup>4</sup> The patient was a girl aged 16. Death resulted from exhaustion. At the post mortem a great mass of hair was found distending the stomach and duodenum. At the Clinical Society of London, in 1871, Gull<sup>5</sup> showed a specimen of a hair tumour weighing five and three-quarter ounces. It was composed of string, thread, cotton wool, and hair of three colours—the hair of the patient's own head and that of her two children.

There are therefore, so far as I have been able to ascertain,

<sup>1</sup> *Annual of the Universal Medical Sciences*, 1892, vol. i. C—16.

<sup>2</sup> *Lancet*, 1886, vol. i. p. 57.

<sup>3</sup> *Annual of the Universal Medical Sciences*, 1889, vol. i. C—23.

<sup>4</sup> *Ibid.* 1892, vol. i. C—16.

<sup>5</sup> *Trans. Clin. Soc. Lond.* 1871, vol. iv. p. 180.

eleven cases on record of this kind of foreign body. In three of them the masses of hair were removed successfully by gastrotomy; while in the others death resulted from causes connected either with imperfect nutrition, or more directly from ulceration and perforation of the stomach wall.

**Symptoms.**—These present considerable variety, but are mostly connected with some form of gastric disturbance. The patient suffers from nausea, vomiting, anorexia with consecutive emaciation, weakness, and exhaustion; there may be marked dyspnoea. In most cases there appears to have been a total absence of symptoms at an early stage; it is only when the mass has increased to a considerable size that indications of some gastric irritation manifest themselves. In Ballinger's case the patient suffered from gastro-intestinal catarrh, with liquid stools, for two and a half years. When the mass reaches a sufficient size, it can be felt as a tumour through the parietes.

**Diagnosis.**—There is nothing sufficiently distinctive about the symptoms to lead one to surmise the nature of their true cause. When it has been possible to feel a tumour by abdominal palpation, it has usually been diagnosed as a malignant growth. In all the cases recorded there has been a history in early life of a habit of swallowing hair, which in more than one instance has been continued on into adult years. The previous knowledge of such a habit, with the co-existence of a tumour in the gastric region, should excite a suspicion as to the possible nature of the complaint.

**Treatment.**—There is little to say with reference to the measures which should be adopted in the event of a correct diagnosis being made. The sooner the body is removed by gastrotomy the better.

---

## CHAPTER XXI

### DISEASE. ULCER

UNLIKE disease of the œsophagus, there are comparatively few of the various complaints which affect the stomach that call for any consideration or interference on the part of the

surgeon. In the case of the œsophagus it has been shown that disease, whether inflammatory or non-inflammatory, is almost certain to give rise to symptoms of an obstructive character, and these, if they do not actually call for surgical interference, will very frequently require a surgeon's opinion. In dealing therefore with diseases of the stomach, only such will be discussed as are likely to call for surgical treatment. It would be supererogatory to trench upon ground which in more than one sense is so essentially within the domain of the physician. In almost every case it is the physician who first sees and diagnoses these forms of disease. The surgeon's opinion is required not so much to discuss the nature of the disease, as to state what he is prepared to do, how he will do it, and with what possible result.

It is only within the last few years that the surgeon has come to the assistance of the physician in the treatment of certain diseases of the stomach. It may therefore be said that, reasoning in the light of the successful incursions made by surgery in other departments of medicine, there yet exists a sphere of labour for the surgeon far beyond his present limited field of operation. It is not, I venture to think, too venturesome to predict that the day is not far distant when the stomach will be opened, explored, and resutured *for purely diagnostic purposes* with as much freedom and security as is now done, for instance, in the case of the brain. I cannot perhaps better illustrate such purely exploratory operations than by quoting two cases recorded respectively by Bradford and Treves. It is true the operation was performed with the belief that the patients were suffering from ulcer of the stomach. In Bradford's case the symptoms pointed unmistakably to such an affection. As will be seen, however, the operations proved to be in their results, though not in their object, purely exploratory ones. The patients, who were aged 25 and 40, made uninterrupted recoveries, and were restored to perfect health.

CASE XLVIII.—*Exploration of stomach by gastrotomy for supposed ulcer: nothing found, but patient completely restored to health.*

An incision was made in the median line from the xiphoid cartilage downwards. The stomach was found somewhat distended, but without thickening. The appearance of the viscus was perfectly normal. Two

fingers were inserted into the abdominal wound, the anterior surface palpated, but no thickenings or adhesions were discovered. The stomach was pulled from one side to the other so that the whole anterior surface could be palpated without difficulty. The lesser cavity of the peritoneum between the stomach and the large intestine was opened a short distance from the border of the former, two fingers inserted beneath the stomach, and two fingers of the other hand placed so as to palpate the anterior surface. Between the two, the posterior surfaces of the stomach could be extensively and thoroughly explored and also any thickening ascertained. No adhesions were found on the posterior surface, and nothing that was abnormal observed. The stomach was then incised, in order to see if any small ulcerations existed. An electric light was inserted and the inner side of the stomach was easily seen, but neither by this nor by the fingers could anything abnormal be determined. The wounds were therefore sewn, and dressed with the ordinary aseptic dressings. The patient made a good recovery and was relieved of all the symptoms. (Bradford, 'Trans. American Surgical Association,' 1892, vol. x. p. 219.)

CASE XLIX.—A man aged 40 years, who was admitted to the London Hospital, had been ill—according to his own report—for twelve years, with pain in the stomach and vomiting. He had vomited blood. He was greatly emaciated. The pain in the stomach was evidently very severe. The stomach was exposed by operation on October 11. It was much enlarged, but exhibited no abnormal appearance beyond this. The stomach was then opened and emptied. The pylorus was examined from within, and every part of the gastric surface explored. No ulcer or other morbid condition was discovered. The gastric and abdominal wounds were closed. The patient recovered well, and all pain in the stomach has now (January 1896) practically disappeared. (Frederick Treves, 'Lancet,' 1896, vol. i. p. 18.)

Mayo Robson,<sup>1</sup> in presenting to the Clinical Society of London two patients whom he had successfully operated upon for adhesion of the stomach, gave utterance, in the course of his remarks, to the following sentiment, which may not inaptly be quoted in support of exploratory operations: 'Although it was difficult to lay down any hard and fast rules, yet personally he should feel it wise, in cases of obscure abdominal pain producing invalidism or debility after medical treatment had been fully tried and failed, to open the abdomen in order to clear up the diagnosis, and then to adopt that line of treatment which seemed to be indicated.'

The diseases, or certain phases of them, which up to the present time have received some form of surgical treatment are—ulcer, carcinoma and other tumours, stenosis of the pylorus,

<sup>1</sup> *Trans. Clin. Soc. Lond.* 1894, vol. xxvii. p. 1.

dilatation, and certain external conditions, where, either by pressure as in the case of tumours, or by distortion as effected by adhesions, various gastric disturbances have been caused. These will now be discussed in the order here given.

**Ulcer.**—While, for reasons above stated, it is unnecessary for the surgeon to be acquainted with all the symptoms which indicate ulcer of the stomach, it is of some importance that he should be familiar with certain pathological aspects of the disease. The first consideration worthy of his attention concerns the ulcer itself, and the second the various complications which may arise in connection with it.

Excluding ulcers the result of traumatism, and such rarer forms as are sometimes associated with syphilis and tuberculosis, the form to be dealt with here is the so-called simple or chronic ulcer of the stomach. It is 'simple' from the fact that, so far as is known, its origin is unconnected with other than local conditions; and it is 'chronic' from the slow progress of the ulceration. There are, however, exceptions to both these conditions. In some cases it would seem that a predisposing cause at least is to be found in some constitutional disturbance; and the progress of the ulcer has been known to run a very rapid course.

As most frequently met with, the ulcer varies in size from a sixpence to a shilling; it presents a somewhat punched-out appearance, with more or less thickened edges, and a base which is thin or thick in proportion to the depth to which ulceration has taken place and adhesions have formed. In situation the ulcer is most frequently found either at the greater curvature or somewhere close to the pylorus. It is much less frequently met with on either the anterior or posterior wall, and least often at the cardiac orifice.

In the process of healing, considerable contractions sometimes take place; not only may the stomach become dilated in parts, but fibrous bands may be present and culs-de-sac created. The most serious results which may accrue from cicatrization are those connected with a distortion or contraction of the pylorus. This complication will be more particularly referred to later.

In the opposite process, that of progressive ulceration, one or more of several issues may happen, depending chiefly on

PLATE VII.

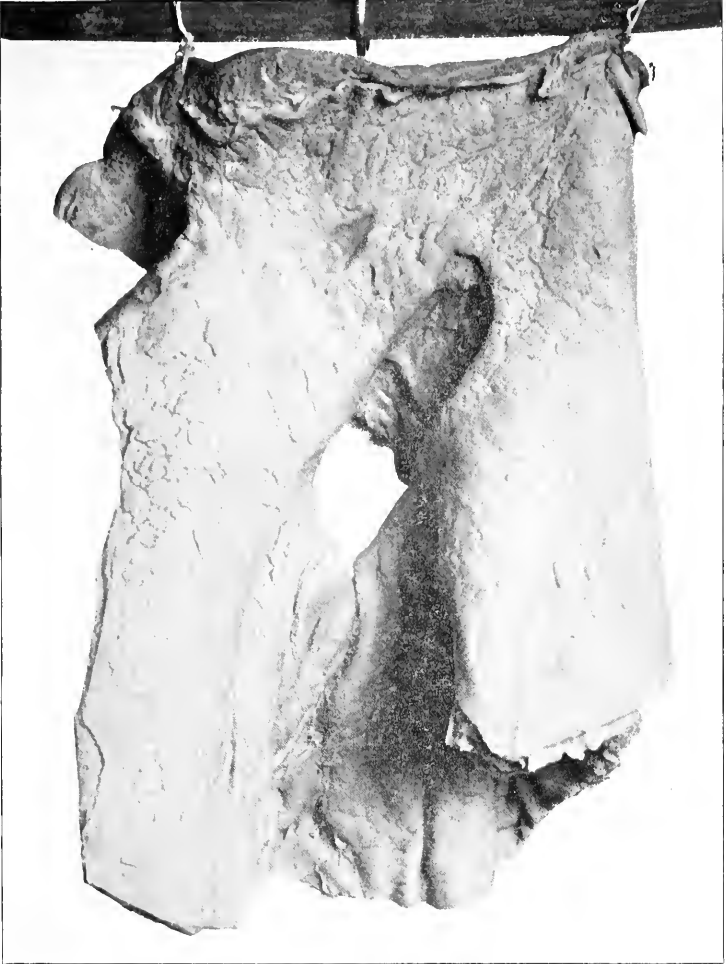

Fig. 14—PERFORATING ULCER OF STOMACH.—The ulcer is situated in the lesser curvature and posterior wall of the stomach. It is oblong in shape, and possesses thin rounded edges. Adhesions existed at the floor of the ulcer, but these had become perforated (R.I.M., Glas.)





the situation of the ulcer and the acuteness of the process. In any case perforation of the stomach will take place. When the process is slow, adhesions are contracted between the floor of the ulcer and neighbouring structures. On the other hand, when ulceration progresses rapidly, a communication is established between the cavity of the stomach and the general abdominal cavity, with all the untoward results which accrue from such a connection.

When once the stomach wall is perforated, and the floor of the ulcer formed by neighbouring organs to which it has become adherent, one of two conditions will result—that is, supposing the ulcerative process is progressive—either a fistulous opening will be established between the stomach and a neighbouring viscus, or an abscess will be formed which may rupture, and thus cause indirectly complications similar to those arising from progressive ulceration independent of suppuration. As to what organs may be involved in one or other of these processes is merely a matter of anatomical detail. Suffice it to say that instances have been recorded illustrative of involvement of every part—viscus or cavity—with which the stomach has anatomical relations.

In discussing those aspects of ulcer of the stomach which may be said to possess features of some surgical interest, it may be well for me to preface my remarks with a few words of caution. The disease is one that in most of its aspects essentially requires rest and not interference. Hence it is only when all reasonable conservative measures have been applied without avail that the physician should consult the surgeon, and the latter should be prepared to act. The following events in the life history of the disease may be said to be worthy of the surgeon's attention: 1. *The character of the ulcer*; 2. *the occurrence of excessive hæmorrhage*; 3. *perforation into the peritoneal cavity*; 4. *formation of abscess*; 5. *fistulous communications*; 6. *adhesions*; 7. *internal contraction*; 8. *pyloric stenosis*.

1. *Regarding the character of the ulcer*.—So far as the ulcer itself is concerned, the surgeon's interest centres upon the possibility of its removal. Whether such a question in treatment is to be entertained is one for the physician originally to decide.

Assuming that the chronicity of the case and other features suggest the advisability of the endeavour, the surgeon will be assisted in his opinion as to its practicability by some knowledge as to the situation of the ulcer. When located near the pylorus, it is in some instances possible to detect a tumour. It may be incidentally remarked here that mistaken diagnoses have not infrequently been made from always connecting a swelling or tumour in the region of the pylorus with carcinoma of that region. Numerous cases are recorded to show what an amount of inflammatory thickening is sometimes associated with ulcer near the pylorus. The detection therefore of such a tumour in this region should not be allowed to mislead when the earlier symptoms unmistakably point to ulcer. When the ulcer is situated in any other part of the stomach, it is very rarely possible to detect its existence by palpation through the abdominal parietes.

Ord<sup>1</sup> thinks that the time at which pain occurs after taking food may throw some light upon the position of the ulcer. Thus when it arises shortly after taking food, or even during a meal, the ulcer is probably in the cardiac region of the stomach. When occurring later, pain in all probability marks increasing distance in the position of the ulcer from the cardiac orifice. Other conditions, however, affecting the patient and the stomach generally have to be taken into account in considering the relative value of pain with reference to the localisation of the ulcer. The co-existence, for instance, of simple hyperæsthesia, or catarrh, would in all probability give rise to considerable discomfort, amounting not infrequently to pain, immediately after food entered the stomach.

Again, the period at which vomiting occurs after ingestion may to some extent indicate the position of the ulcer. Early vomiting after food may indicate implication of the cardiac region; but when occurring later, and still more when it arises after several successive meals, the ulcer may be considered as located in the pyloric region. The attitude of patients during the paroxysms of pain is also sometimes helpful in suggesting the seat of the lesion. Thus the patient will probably assume such a position as will tend to obviate the

<sup>1</sup> *International Journal of the Medical Sciences*, 1889, vol. i. p. 552.

pressure and irritating effect of the ingesta upon the ulcer. The dorsal position would be that likely to be adopted by a patient with an ulcer located on the anterior wall of the stomach, and *vice versa*. Similarly a patient might find greater relief in lying on the left side when the ulcer is situated about the pylorus, and *vice versa*.

With all the aid, however, that can be derived from such suggestive symptoms, the only absolutely certain knowledge of the situation of the ulcer, and the possibility of its removal, can be obtained from an exploratory laparotomy. For although we may approach beforehand to within a measurable distance of practical certainty as to the situation of the ulcer, it still remains impossible for us to decide, prior to operation, whether there are or are not adhesions of such a character as renders removal impracticable. Again, there is always the possibility of more than one ulcer being present. (See Plate VIII, fig. 15.)

Assuming that the ulcer is single, suitably located, and not inseparably connected with any important structures, its successful removal may fairly be entertained. The conditions, however, with which the surgeon is almost always more likely to be confronted are not those most favourable for the success of his operation, but just those where the greatest difficulties are liable to exist. Thus it is only after protracted endeavours by various conservative measures, and the failure of these, that his aid is called in; and then he has to deal with an ulcer which will only too likely be, if not extensive in area, at least very extensive in the results it has produced in its immediate vicinity. If located posteriorly, it will be intimately bound down to the pancreas; if near the pylorus, there will possibly be contortion of that orifice, with probably some obstruction from inflammatory infiltration and induration; and if in a part of the stomach where the relations of the viscus are freer, serious contraction and alterations in its shape may already have taken place. The surgeon therefore will have to decide, from the conditions found after a careful physical examination of the stomach through an abdominal incision, whether he deems it wise to proceed further and attempt some plastic operation or anything so radical as excision. Suffice it to say that not a few cases are now on record where successful excisions have been performed. As ex-

amples may be mentioned the following: A successful case by van Kleef;<sup>1</sup> and another by Postempski of Rome, quoted by Bradford.<sup>2</sup> One successful excision has been reported from Billroth's Clinique.<sup>3</sup> In this case the stenosed pylorus was also removed. Maurer<sup>4</sup> also successfully excised an ulcer. Lange<sup>5</sup> succeeded in excising a very large ulcer. The hard disc in the anterior wall of the stomach measured from four to five inches in diameter, of which the ulcer itself occupied a central area about three inches in diameter. The patient was a butcher aged 25 years, and was dismissed from the hospital about four weeks after the operation.

2. *Excessive hæmorrhage.*—Hæmorrhage is far from being a constant symptom in ulcer of the stomach, occurring apparently in less than fifty per cent. of the cases. Still less frequently does it occur with any degree of severity. It is, however, in some of these severe cases that surgery may lend valuable assistance. 'When violent hæmorrhage,' says Ewald, 'has once set in, the danger of its recurrence hangs like the sword of Damocles over the head of the patient.' Fatal hæmorrhage appears to be comparatively rare, and possibly in many, if not in most, of these cases death will be unpreventable, whatever the measures employed. It is unlikely that where either the splenic artery or the portal vein has been opened into, and still more so when the left ventricle of the heart has been perforated, that any means at our disposal, medical or surgical, could prevent an untoward result. Short, however, of hæmorrhage from such sources, where death must rapidly ensue, severe bleeding from smaller vessels with serious symptoms might reasonably be dealt with by the same means now frequently employed for losses of large quantities of blood due to various other causes. Since Wooldridge's original paper, transfusion has been simplified to such an extent that no patient suffering from loss of blood, no matter what the cause, should be allowed to die without such a simple measure as here advocated. All that is required is a small cannula for

<sup>1</sup> *Centralblatt für Chirurgie*, 1882, No. 46, p. 756.

<sup>2</sup> *Trans. Amer. Surg. Assoc.* 1892, vol. x. p. 219.

<sup>3</sup> *Archiv für klin. Chir.* 1889, vol. xxxix. p. 799.

<sup>4</sup> *Ibid.* 1880, vol. xxx. p. 2.

<sup>5</sup> *New York Med. Journ.* 1892, vol. lv., p. 584.

PLATE VIII.



Fig 15.—PERFORATING ULCERS OF STOMACH.—The two parts were removed from the same organ. The upper shows the flattened slightly depressed cicatrix of a large healed ulcer, and cicatrices of smaller ones. The lower shows a deeply excavated ulcer which had caused death by perforation into the peritoneal cavity. (*W.I.M., Glas.*)



insertion into a vein, an indiarubber tube about a couple of feet long, one end of which is attached to the cannula, the other to the nozzle of the filler or funnel. A quantity of so-called normal saline solution is taken—that is, water (sterilised if possible) at a temperature of from 105° to 110° F. and containing a teaspoonful of common table salt to a pint of the fluid. This is poured into the glass receptacle and allowed to flow slowly into the vein. From one to five or six pints may thus with perfect safety be passed into the patient's circulation, provided all the little necessary surgical precautions are taken in reference to treatment of the wound and the introduction of the fluid. In a case reported by Dewhurst<sup>1</sup> such a line of treatment was entertained, but was apparently too late in its adoption to be of any service.

Mikulicz<sup>2</sup> reports a case of obstinate hæmorrhage which was uncontrollable by ordinary medicinal measures, where he performed laparotomy, incised the stomach along the anterior wall, and then cauterised the ulcer with the thermo-cautery. Death occurred fifty hours after the operation. Küster<sup>3</sup> has in two cases opened the stomach, cauterised the ulcer, and performed gastro-enterostomy. Both cases did well.

---

## CHAPTER XXII

### ULCER (*continued*): PERFORATION

3. *Perforation*.—As here used, perforation is intended to imply a more or less direct communication between the cavity of the stomach and the general peritoneal cavity. With the exception of sudden and severe hæmorrhage there is no complication of gastric ulcer more serious or more difficult to deal with. While the accident is not inevitably a fatal one, it is so in the large majority of cases. Parsons<sup>4</sup> carefully examined the literature of the subject, and could find recorded only nine cases which presented symptoms indicative of perforation of a gastric ulcer and recovered. Of these, three

<sup>1</sup> *Lancet*, 1892, vol. ii. p. 141.

<sup>2</sup> *Archiv für klin. Chir.* 1887, vol. xxxvii. p. 79.

<sup>3</sup> *Centralblatt für Chirurgie*, 1894, No. 51, p. 1254.

<sup>4</sup> *Dublin Journal of the Medical Sciences*, 1892, vol. xciv. p. 26.

died subsequently from this affection ; but in only one of them did the post-mortem examination seem to confirm the original diagnosis. This case is reported by Hughes, Ray, and Hilton in the ' Guy's Hospital Reports ' for 1846.<sup>1</sup> The rapidity also with which a fatal issue ensues is second only to that of excessive hæmorrhage. In Fagge's experience nearly all the cases of perforating ulcer were fatal in less than twenty-four hours.

The question therefore of treatment in this particular complication does not admit of much time being spent in its consideration. Whatever is to be done will have to be done quickly, and experience so far goes to prove that success depends chiefly upon the shortness of the time which is allowed to intervene between the onset of the acute symptoms and the performance of the operation.

That the acute symptoms of perforative peritonitis with which the patient is suddenly struck down owe their origin to the rupture of a gastric ulcer is often purely conjectural. As pointed out by Treves<sup>2</sup> in his Lettsomian Lectures on Peritonitis, ' All quite acute troubles within the abdomen commence with the same train of symptoms. . . . Until many hours have elapsed it is often impossible to say whether a sudden abdominal crisis is due to the perforation of a vermiform appendix, or to the bursting of a pyosalpinx, or to the strangulation of a loop of intestine, or to the passage of a gall stone.' It might be reasonably supposed that the previous history of the case would always lend a sufficient aid towards the detection of the true cause. Unfortunately in a large number of these cases there is no early history of ulcer ; the patient has been completely free, or almost so, from any gastric disturbance until suddenly seized with severe symptoms. The difficulties which the surgeon has to encounter in his treatment are no less than those which the physician has in arriving at a correct diagnosis. It is not possible beforehand to localise the seat of the perforation, to define its limits, or to say how it will have to be dealt with when discovered ; neither is it within his power to say whether the condition of general peritonitis which has arisen is too far advanced to be recovered from.

<sup>1</sup> New Series, vol. iv. p. 343.

<sup>2</sup> *Brit. Med. Journ.* 1894, vol. i. p. 455.



In consideration of the difficulties therefore which exist both in respect of diagnosis and treatment, it will be well to discuss somewhat in detail various points in connection with both these aspects of the question.

These cases may be said to class themselves under two heads. First there are those where the symptoms though acute are not markedly so, and where perforation is known to have occurred on an empty stomach; and, secondly, those where the symptoms from the commencement are excessively acute, and where perforation has taken place during or shortly after a meal. In the latter class, the only chance of life rests in operation, and that performed at the earliest possible period of the attack. In the former there would seem to be some reason for raising the question of delay, since recoveries without surgical interference have been known to occur. Hall<sup>1</sup> records such an instance, and refers to six others. In three of these it was known for certain that the stomach was practically empty at the time of the perforation, and in the other three the narrative of each case suggests that a similar condition existed.

There are two other conditions besides those which have direct reference to the state of the stomach at the time of perforation which should have some weight in determining the advisability or not of immediate operative interference; these are, the position of the patient at the time of the accident, and a history of previous attacks of pain. In the former instance a patient at active work in the erect attitude is more likely to have a large extravasation of the contents of the stomach into the peritoneal cavity than one who is seized at night in the recumbent position. In the latter instance a history of periodical attacks of pain will probably indicate attacks of local peritonitis, and as a consequence the existence of adhesions. In such cases the perforation may not prove of the same magnitude as where no adhesion exists.

The purely operative aspects of the question concern first the most suitable place to open the abdomen, and second, the treatment of the gastric lesion.

To expose the stomach the best incision is one carried downwards from just below the ribs for about three or four

<sup>1</sup> *Brit. Med. Journ.* 1892, vol. i. p. 64.

inches and slightly to the left of the median line ; this can be subsequently enlarged in the direction required. To flush and drain the peritoneal cavity the best incision is one carried through the parietes in the median line below the umbilicus. To wash out the abdominal cavity and leave a leaking orifice would prove almost as fatal as to close the perforation and leave some of the escaped contents of the stomach in the dependent parts of the peritoneal cavity. The wisest course of procedure would therefore seem to be to make first the incision above the umbilicus so as to expose and examine the stomach ; then, if the leakage has been considerable and it is not found possible to satisfactorily flush and remove all extravasated material, to make a second opening below the umbilicus through which perfectly efficient drainage of the peritoneal cavity can be established. While the very fatal nature of these cases, when left alone, admits of considerable risk being run in the way of operative treatment, it seems better to operate by two abdominal incisions than to adopt the severer measure of laying the abdomen open from symphysis to xiphoid cartilage, as performed in one case by Mikulicz. The extent of the incision is not, however, so vital as the efficient cleansing of the peritoneal cavity, and must be considered therefore subservient to all that concerns the latter.

Assuming that the stomach is exposed by the upper incision, a careful search is made for the seat of perforation. This may be detected either by the existence of adhesions binding down the floor of the ulcer to neighbouring parts, or by the thickening in the wall of the stomach immediately around the ulcer and seat of perforation. The locality of the lesion once determined, an endeavour should be made to bring the affected portion of the stomach up to the abdominal incision. As likely as not this will be found impossible either from the position of the ulcer or from the adhesions which it has contracted to other parts. If freer access to the part appears desirable, and this can be attained by a transverse incision, the rectus should be divided, the branches of the internal mammary being secured as they are severed. Before proceeding further to deal with the perforation, an endeavour should be made to ascertain the condition

of the stomach with regard to its contents. If perforation has taken place during or shortly after a heavy meal, it will be wise to relieve the stomach of its load. This may be done either through the perforation itself, or through the œsophagus by means of a tube. The selection of the method will depend upon the extent to which the perforation itself can be manipulated. Any further extravasation into the peritoneal cavity should be carefully avoided.

In dealing with the perforation four alternatives are open for adoption according to circumstances: (1) Excision of the ulcer, including the seat of perforation, and union of the edges of the wound in the usual way; (2) simple suture of the perforation by Lembert's method; (3) union of the perforated gastric area with the parietal wound; (4) open drainage.

(1) *Excision of the perforated ulcer.*—While this is the most radical procedure, and theoretically the most suggestive, it is frequently the least practicable. If not the position of the ulcer, its size and amount of surrounding induration may render it quite inadvisable to attempt so large an excision of a part of the stomach. Where, however, excision does seem feasible, there can be little doubt that it is ideally the best treatment. Jowers succeeded in the case of a woman aged 24 years. The ulcer was situated near the cardiac end, and was excised by means of scissors. Dalziel similarly succeeded in a woman aged 26.

(2) *Simple suture of the perforation by Lembert's method.*—This method, which has strongly in its support the fact that it has several times been successfully accomplished, consists in closing the opening by suture; that is to say, the stomach is picked up in a fold on each side of the ulcer and united over it by a few Lembert sutures—the ulcer, as it were, being tucked in. Gilford reports having successfully adopted this method. The patient died thirty-one days after the operation from septicæmia. Kriege also records a success. He treated his patient seventeen hours after the acute symptoms began. The patient did well at first, but after about five weeks an empyema developed in the left pleural cavity. This was opened, and the patient made a perfect recovery. Morse read a paper before the Royal Medico-Chirurgical Society of London on a case upon which he had successfully operated five hours after

the onset of the acute symptoms. The perforation was closed with Lembert stitches, the peritoneal cavity freely flushed, and the patient three weeks afterwards was quite well. Maclaren related a successful case at a meeting of the British Medical Association at Bristol in 1894. The patient was a girl aged 14 years, and the operation was performed nine hours after perforation. T. Holmes,<sup>1</sup> in the second of his Hunterian Lectures, quotes a case successfully treated by Bennett. An opening about the size of a little finger was found in the posterior wall of the stomach. It was stitched up. The operation was performed about nine and a half hours after the onset of the symptoms. A very successful result was obtained in a case reported by Nicholson. Laparotomy was performed three hours after perforation. The ulcer with the perforation was found on the anterior and upper surface, very near the entrance of the œsophagus. Suture was performed. Recovery set in immediately. Lundie showed a patient at the Edinburgh Medico-Chirurgical Society upon whom he had successfully operated ten hours after the first onset of the acute symptoms. The ulcer was stitched up, and there were already signs of acute general peritonitis. L. A. Dunn succeeded in closing a perforation one-third by a quarter of an inch, situated in the anterior wall of the stomach near the pylorus. The patient ultimately made a rapid recovery. J. H. Walters was similarly successful in closing a perforation thirteen and a half hours after the onset of symptoms. In a case reported by Bilton Pollard, the ulcer was situated near the cardiac end of the stomach and on the anterior surface, about an inch and a half from the greater curvature. In order to properly expose the part the parietal incision had to be enlarged by a transverse one dividing the rectus muscle. The perforation measured half by one-third of an inch, and the stomach wall for about two inches around was much indurated. The orifice was stitched up seven and a half hours after the perforation. The patient made an excellent recovery. W. J. Maurice operated in a case nine hours after perforation; a small opening was found on the anterior surface of the stomach, it was closed by two rows of Lemberts, and the patient made a good recovery. H. Morris operated on a case four hours after perforation.

<sup>1</sup> *Brit. Med. Journ.* 1894, vol. ii. p. 863.

The aperture was found on the anterior aspect of the stomach, close to the pylorus and near the greater curvature. The patient recovered.

(3) *Stitching the seat of perforation to the abdominal incision.*—This method entails the temporary formation of a gastric fistula. Haward communicated a case to the Clinical Society of London where such a method was adopted. The patient, a woman aged 26, was admitted into the hospital in a state of collapse due to the perforation of a gastric ulcer. She was operated upon fourteen hours after the onset of the acute symptoms. An ulcer, the perforated centre of which would admit a finger, was found opening into the general peritoneal cavity. Owing to the great infiltration and thickening of the gastric wall, excision could not be performed. The stomach was therefore sutured to the abdominal wall, and the margin of the ulcer to the edge of the incision. A drainage tube was inserted into the stomach, the peritoneal cavity washed out, and the rest of the wound closed. The patient died six weeks afterwards from purulent consolidation of the bases of both lungs. Parsons also records a partially successful case, which is more fully described as Case L. at the conclusion of this chapter.

(4) *Open drainage.*—Whether it is possible to bring the perforation up to the abdominal incision for efficient union of the parts will naturally depend upon the locality of the ulcer and the amount of existing adhesions. It is quite possible that the surgeon may find that he is unable to carry out any one of the measures above described. In such a case his only resort is to free drainage. A tube must be passed down to the perforation and secured there, so that any further extravasation is conveyed out through the abdominal wound. This method was successfully carried out by Paul, who tied a glass tube into the front wall of the stomach. The ulcer was situated at the cardiac end of the lesser curvature. In a case reported by J. W. Taylor,<sup>1</sup> the stomach was left alone and drainage trusted to. This case is interesting also from the extremely collapsed condition of the patient at the time of operation, which was performed twenty-four hours after the acute symptoms first showed themselves. The pulse was indistinguishable and the patient almost moribund. Rapid

<sup>1</sup> *Birmingham Med. Review*, 1888, vol. i. p. 159.

improvement took place immediately after the operation, and the patient died some weeks later from acute obstruction. Silcock, in operating upon a case, found a wide band of fibrous adhesions binding the anterior surface of the stomach to the under surface of the left lobe of the liver. The adhesions were left alone and a drainage tube conducted down to the part. The patient made an uninterrupted recovery.

For the various references in connection with the cases quoted above, see the following table :

*Cases of Perforation of Gastric Ulcer successfully treated by Operation since 1891*

Name of Operator	Sex and Age	Situation and Size of Perforation	Interval between onset of symptoms and operation	Treatment of Peritoneal Cavity	Reference
(1) BY EXCISION					
R. F. Jowers .	F. 24	Posterior surface, near cardiac end. Size of three-penny piece	6 hours	Flushed with boiled water	<i>Lancet</i> , 1895, i. 544
T. K. Dalziel .	F. 26	Anterior surface close to pylorus. $\frac{1}{2}$ by $\frac{1}{4}$ inch	5 $\frac{1}{2}$ "	Sponging and use of aseptic water	<i>Glasgow Med. Journ.</i> 1896, xlv. 302
(2) BY SIMPLE SUTURE					
Kriege . .	M. 41	Anterior wall, 3 cm. from cardia. Size of a pea	17 hours	Wiped out with gauze. Gauze drainage inserted	<i>Berl. Klin. Wochen.</i> 1892, 1280
H. Gilford .	F. 20	Posterior surface, near cardiac orifice. Perforation admitted finger	13 "	Flushed with water and creolin. Drainage	<i>Brit. Med. Journ.</i> 1893, i. 944
T. H. Morse .	F. 20	Anterior surface, near cardiac end	5 "	Flushed	<i>Trans. Med.-Chir. Soc. Lond.</i> 1894, lxxvii. 187
R. Maelaren .	F. 14	Anterior surface, 2 inches from cardiac end	9 "	Flushed	<i>Brit. Med. Journ.</i> 1894, ii. 863
R. H. B. Nicholson . .	F. 32	Anterior and upper surface, near cardiac end	3 "	Flushed with boiled water	<i>Ibid.</i> 982
B. Pollard .	F. 18	Anterior surface, $1\frac{1}{2}$ inch from greater curvature. Perforation $\frac{1}{2}$ by $\frac{1}{4}$ inch	7 $\frac{1}{2}$ "	Flushed with warm water. Sponged dry	<i>Ibid.</i> 1895, ii. 14
W. H. Bennett	F. 41	Posterior surface. Admitted point of little finger	9 $\frac{1}{2}$ "	Peritonitis present. Flushed with warm water	<i>Ibid.</i> 70
R. A. Lundie .	F., young	Anterior surface. Eyelet hole in a boot	10 "	Peritonitis present. Flushed	<i>Ibid.</i> i. 198

Name of Operator	Sex and Age	Situation and Size of Perforation	Interval between onset of symptoms and operation	Treatment of Peritoneal Cavity	Reference
(2) BY SIMPLE SUTURE— <i>continued</i>					
J. H. Walters .	F. 20	Anterior surface, towards lesser curvature, 3 inches from cardiac orifice	13½ hours	Flushed with weak boracic solution	<i>Lancet</i> , 1895, i. 484
W. J. Maurice	F. 19	Anterior surface, near cardiac end	9 "	Flushed with water	<i>Ibid.</i> ii. 981
H. Morris .	F. 24	Anterior surface, close to pylorus and greater curvature. No. 12 catheter	4 "	Flushed with 1 in 400 carbolic solution. Pelvis sponged out	<i>Ibid.</i> ii. 1573
L. A. Dunn .	F. 15	Anterior surface, near pylorus, ¼ by ¼ inch	2½ days	Flushed with warm boiled water	<i>Trans. Clin. Soc. Lond.</i> 1895, xxviii. 204
(3) BY STITCHING PERFORATION TO PARIETES					
W. Haward .	F. 26	Threepenny piece	14 hours	Flushed	<i>Ibid.</i> 1893, xxvi. 179
A. R. Parsons .	F.	Anterior surface near cardiac end and lesser curvature	9 "	Flushed	<i>Dub. Journ. Med. Sci.</i> 1892, xciv. 29
(4) BY DRAINAGE AND STUFFING					
F. Paul . .	F. 31	'In an almost inaccess-ible position'	9 hours	Drainage tube into front wall of stomach for 15 days. Fistula closed 14 days later	<i>Brit. Med. Journ.</i> 1895, i. 759
A. Q. Silcock .	F. 24		A few hours		<i>Trans. Clin. Soc. Lond.</i> 1895, xxviii. 217
C. J. Parker .	F. 25		Perforation occurred at the time of operation	Flushed, and perforated area stuffed	<i>Annals of Surgery.</i> 1896, xxiii. 735

The last part of the operation, after the perforation has been dealt with, concerns the efficient washing out and draining of the peritoneal cavity. It has already been indicated that to accomplish this with the amount of certainty requisite for a successful result, it may be necessary either to enlarge the incision downwards or to make a second incision below the umbilicus. If on opening the abdomen at the earlier stage particles of fat or food are seen to escape from the upper incision, it may almost certainly be concluded that some of this same material will have found its way down into the

most dependent parts of the abdominal cavity; and to ensure its complete removal from the pelvis, a second incision or an extension of the first must be made. To flush the peritoneal cavity, quantities of boiled water reduced to the requisite temperature of about 100° F. should be poured in, and to secure the free irrigation of all parts, the coils of intestine should be gently moved about by the fingers of one hand. Experience has quite sufficiently proved the needlessness of using any weak antiseptic reagent when warm sterilised water is obtainable. And for all the weak antiseptic properties that such diluted solutions of these reagents possess, it is more than probable that plenty of clean warm water answers the purpose perfectly. That the introduction of antiseptics within the peritoneal cavity is not without danger has been amply proved. In one of the cases already quoted, the introduction of creolin into the flushing fluid caused symptoms of poisoning.

Finally, the insertion of one or more drainage tubes well into the pelvis should always be adopted where the leakage from the stomach has been marked. Failing, however, any such obvious extravasation, the wound in the abdominal parietes should be completely closed.

The after treatment in these cases is of some moment. The stomach requires to be given as much rest as possible; and although in some of the successful cases something has been administered by the mouth within twenty-four hours of the operation, it is safer that nourishment should for the first few days be administered by nutrient enemata, and nothing more than a little ice given by the mouth if so required. These patients fortunately are not so reduced that they cannot stand a comparatively prolonged period of abstinence from food by the mouth. No haste therefore should be exercised in returning to the natural method of nutrition.

CASE L.—*Perforation of gastric ulcer: laparotomy: suture of perforation. Recovery.*

A young woman aged 24 years had enjoyed good health until two years ago, when she became subject to indigestion, which, however, had only given trouble during the preceding six months. The chief symptom was epigastric pain very soon after taking food and lasting for some two hours. During the previous three months there had also been sickness after food, sometimes on several successive days, and for the last six or eight weeks she had not touched meat or potatoes on account of the pain



which followed. On one occasion, some four months previously, she vomited a small quantity of dark blood. The patient was in her usual health on the morning of the 10th inst. and took boiled haddock at her midday meal (12.30). At 2.30 p.m., as she was hurrying up stairs, she was suddenly seized by a strong 'drawing' pain in the lower abdomen. This rapidly increased in area and intensity, and by the time she reached the hospital, an hour later, had spread over the whole abdomen. She managed to walk to the hospital, about a quarter of a mile, but was doubled up with pain and felt faint. There was no vomiting. Physical examination of the abdomen showed slight uniform distension; the parietes were flaccid, and gentle palpation could be borne without pain. The percussion note everywhere was tympanitic, and the liver dulness was completely obliterated. An hour later, the face, which at first was flushed and comparatively normal in appearance, became anxious and somewhat pinched; the abdomen became rigid and acutely tender. Distension also increased.

*Operation.*—Four hours after the onset of the symptoms laparotomy was performed. A median incision four inches long (subsequently enlarged) was carried from the costal angle towards the umbilicus. On opening the peritoneal cavity offensive gas escaped. On drawing the stomach up into the wound, a perforation the size of a No. 12 catheter was brought into view. It was situated close to the pylorus on the anterior surface, near the greater curvature. The ulcerated portion of the stomach was invaginated by means of eight Lembert sutures of No. 2 silk, a second row of sutures being placed more superficially to strengthen them. The peritoneum was thoroughly irrigated with a 1 in 400 carbolic solution at 105° F., and the pelvis sponged out as dry as possible. The various peritoneal pouches were similarly dealt with. Much lymph was removed from the surface of the liver. The abdominal wound was closed with nine thick silk sutures, and the usual dressing applied. For the first three days nothing was given by the mouth except a little hot water, but on the third day two teaspoonfuls of hot tea and milk were given every hour. Afterwards arrowroot was given, but for the first week nourishment was mostly by nutrient enemata. About four weeks after the operation she left the hospital cured. (W. Pasteur and Henry Morris, 'Lancet,' 1895, vol. ii. p. 1573.)

CASE LI.—*Perforation of gastric ulcer: laparotomy and fixation of the gastric opening to the edge of the parietal incision. Death on the sixth day.*

During the two years immediately preceding the symptoms of perforation, the patient, a woman, had been in the infirmary three or four times suffering from attacks of severe pain in the stomach. These attacks were not very closely related to meal times, as they occurred sometimes before, sometimes after, and often quite independently of partaking of food. She never vomited any blood. The existence of an ulcer of the stomach was entertained, but with no great degree of certainty. After four days of more acute pain than usual, during which time she continued at her work, but could take but little food, she was suddenly seized

a little after eight o'clock on the morning of December 21 with most violent pain. When seen at 9.30 A.M., she referred the pain to the left hypochondriac region. The pulse was 100 per minute; respirations were tolerably deep. An examination of the region to which the pain was referred failed to detect anything abnormal. At 11 A.M. the collapse was much more marked, the pulse 110, finger nails were blue, face was drawn and anxious, and the patient rather cold in spite of various external warm applications. On examination the area of hepatic dulness was found to be diminished and the note over the hepatic region abnormally tympanitic. At four o'clock laparotomy was performed. By this time the pulse had increased somewhat in frequency, but otherwise there was no marked change in her condition. Immediately the peritoneal cavity was incised an escape of gas took place, thus confirming the fact of perforation, the site of which was found to be the anterior wall of the stomach in its lesser curvature near its junction with the œsophagus. The wall of the stomach all round the perforation was thickened, swollen, and so soft that sutures at once cut through it. The external circumference of the stomach at this part appeared so small that no hope could be entertained of excising the ulcer completely without leaving too great a constriction. The stomach was therefore drawn up by stitches to the edges of the abdominal wound and carefully sutured there. The peritoneal cavity was then flushed out and the lower part of the abdominal incision closed, leaving a gastric fistula. The patient rallied well from the operation, and made satisfactory progress until Wednesday—two days after the operation—when a change for the worse set in, and she died on Sunday, just six days after operative interference. (Parsons, 'Dublin Journal of the Medical Sciences,' 1892, vol. xciv. p. 29.)

---

## CHAPTER XXIII

ULCER (*continued*): FORMATION OF ABSCESS; FISTULOUS COMMUNICATIONS; EXTERNAL ADHESIONS; INTERNAL CONTRACTION; PYLORIC STENOSIS

4. *Formation of purulent collections and other septic changes.*—As a sequel to gastric ulcer, the formation of an abscess is by no means an infrequent occurrence. In some instances the septic mischief which arises does not take the form of an abscess. Thus pericarditis, pleurisy, empyema, and pneumonia are occasionally met with. Whatever may be the septic nature of the more distant complications, they are usually found to be secondary to some primary formation of pus in the immediate neighbourhood of the ulcer. It would seem to be rare for any septic absorption to

take place from the ulcer itself, independent of the first production of inflammatory adhesions and other mischief at the floor of the ulcer. The intrathoracic complications are almost always due to the pre-existence of a so-called sub-diaphragmatic abscess. Out of twenty-eight cases collected by Dickinson<sup>1</sup> of this latter complication, eighteen manifested some form of intrathoracic trouble.

The interest of these cases to the surgeon centres in the situation and extent of the purulent collection. While it is far from being always possible to state that a certain intra-abdominal abscess situated in the upper half of the abdomen owes its origin to a gastric ulcer, a very safe assumption may be made that such is the cause when a previous history exists of symptoms indicative of ulceration. The abscess, when aspirated or opened, is frequently found to have fetid and gaseous contents.

Suppuration commences as a rule in direct connection with the ulcer. Hence it often happens that when the ulcer is situated on the posterior aspect of the stomach, a considerable collection of pus takes place before there is any external manifestation of it. Again, it sometimes happens that the fulness which eventually manifests itself in the abdominal parietes does not present the dull sound indicative of a collection of fluid, but a tympanitic note due to the gas which the cavity contains. In some instances the pus does not collect to any extent in the immediate neighbourhood of the ulcer, but burrows to a distant part and then creates for itself a cavity. In a case reported by West,<sup>2</sup> an abscess situated in the left loin was found to extend into the pelvis and upwards to the diaphragm and under the left lobe of the liver to the stomach. Here the stomach and the liver were found adherent, and a perforation was discovered the size of a threepenny piece.

In those cases where there is pylephlebitis with multiple abscesses in the liver and elsewhere, and specially such as have purulent collections in distant parts, like the parotid, the condition must be considered pyæmic in character.

One of the most interesting forms of abscess dependent upon gastric ulcer is the so-called subphrenic or subdiaphragmatic. Dickinson, following the nomenclature of Leyden,

<sup>1</sup> *Brit. Med. Journ.* 1894, vol. i. p. 234.

<sup>2</sup> *Ibid.* 1893, vol. i. p. 731.

uses the term subphrenic pyo-pneumothorax, on account of the collection of pus and gas not being strictly of the nature of an abscess, but a collection of fluid bounded by the peritoneal walls. The foul gas and pus which constitute the contents of these collections may be found anywhere beneath the diaphragm and between it and the liver. The more usual locality is the left hypochondriac region. When the cavity or collection of fluid and gas has reached a sufficient size, a fulness presents itself in the epigastrium, and on percussion a tympanitic note may be heard over the swelling and extending either to the right or the left.

The constitutional symptoms which may be manifested as the result of a localised collection of pus vary considerably. In some cases the onset of the symptoms is acute, while in others there is but little disturbance of the patient's general condition throughout the course of abscess formation. In one of Dickinson's recorded cases the patient had been suffering for three weeks before admission to the hospital, from painfulness and increasing prominence of the upper abdomen. A week before admission he was attacked with severe pain like colic, with which 'he was doubled up for two hours.' In addition there was much sweating coupled with feverishness, but no rigor.

Localised pain with feverishness occurring in cases known to have previously exhibited unmistakable symptoms of gastric ulcer should always awaken a suspicion of some active septic mischief taking place. The symptoms associated with abscess formation sometimes mislead by resembling more strongly symptoms usually associated with inflammation elsewhere. Thus two cases of perforating ulcer with subdiaphragmatic abscess are reported by Salter and Dickinson,<sup>1</sup> in neither of which was a correct diagnosis made. In one the symptoms pointed to its being a case of pericarditis, and in the other to one of pneumothorax. Both patients died, but in neither case were the conditions found, which were supposed to exist during life.

The treatment of these cases consists in giving a free exit to the pus wherever located. A free incision may always be made when the collection of pus has increased to the extent of causing a prominence on some part of the abdominal surface.

<sup>1</sup> *Lancet*, 1891, vol. i. p. 541.

Adhesions will have been contracted between the abscess cavity and the abdominal parietes, so that, provided the incision is kept within a reasonable length, the danger of opening the general peritoneal cavity is remote. A large-sized drainage tube should be inserted and retained, and the abscess cavity freely irrigated with some antiseptic. The extreme fœtor of the pus induced me on one occasion, when operating upon a case of this class, to make a counter opening, with the object of more freely draining the cavity. In doing so, however, I unfortunately opened the lower part of the pleural space, and had subsequently to deal with a pyo-pneumothorax. I should not be induced again to attempt to drain more freely than can be perfectly well accomplished through a single opening and a large drainage tube. One can always be sure that where the abscess projects most prominently, there the adhesions will be most secure. And while in my case the finger inserted within the abscess cavity seemed to impinge directly upon the skin wall at another point on the body surface, still, as I unfortunately learnt, there proved to be no proper security against the infection of other parts.

Provided there are no other complications of any gravity, the result of opening and draining these fœtid collections of pus is usually good. The cavity gradually contracts and finally becomes obliterated.

CASE LII.—*Gastric ulcer with formation of subphrenic abscess: operation: recovery. Death subsequently from septicæmia.*

M. McL., aged 27, a housemaid, was admitted on July 18, 1893, under the care of Dr. Whipham. There was a history of old anæmia and dyspepsia. Fourteen days before admission she had been attacked by sudden severe pain at the epigastrium with vomiting, and a week later by symptoms of pleurisy on the left side. On admission a subphrenic abscess in connection with a gastric ulcer was diagnosed, there being a tympanitic prominence in the epigastrium, the tympanitic note extending to the left and upwards as high as the nipple, besides which there were signs of left pleural effusion with compression of lung. In the course of three days these signs increased and extended, and a modified bell-note became obtainable over part of the tympanitic region. On July 22 Mr. Pick opened the abdomen above the umbilicus, finding a circumscribed cavity beneath the diaphragm, into which the left lobe of the liver projected, containing foul gas and pus mixed with fatty food. The perforation of the stomach was not found, being probably closed. On August 12 an empyema of the lower part of the left pleura was opened, giving exit to pus which was

very foul, although there was no perforation of the diaphragm. The abdominal wound was healed by August 28, and for nearly a fortnight afterwards the patient made good progress; but then diarrhœa and other symptoms of septic poisoning set in, and she succumbed on September 15. At the necropsy it was found that the abscess cavity had entirely contracted. There was a cicatrised ulcer on the small curvature and posterior surface of the stomach adherent to the pancreas, the neighbouring part of the stomach being adherent to the under surface of the left lobe of the liver. (Lee Dickinson, 'Brit. Med. Journ.' 1894, vol. i. p. 234.)

5. *Formation of fistulæ*.—Two kinds of fistulæ result from the perforation of a gastric ulcer. First there are those which pass between the stomach and the bowel, and secondly those between the stomach and the cutaneous surface.

The usual method by which a connection is established between the cavity of the stomach and that of the intestine is that adhesions are contracted between the floor of the ulcer and the wall of the bowel. The process of ulceration continuing, perforation takes place, and a fistula is formed between the two. A more indirect method is for an abscess to form first in connection with the perforated ulcer, and then for this to burst into the bowel. In whichever way the communication is established, the result is the same; an intercommunication takes place between the contents of the two viscera—the gastric material passing into the bowel, and *vice versa*. From the more constant and fixed relation of the colon to the stomach, a fistulous communication is more frequent between these two than between the stomach and the small intestine.

The symptoms of fistula bimucosa are dependent upon the escape of the fæces into the stomach and the gastric contents into the bowel. In the former case the patient will probably vomit material which will suggest the region of the intestinal tract from which it has escaped: the lower down the communication, the more will the ejecta resemble the character and consistency of true fæcal matter. In the latter, the premature escape of the imperfectly digested stomach contents into the bowel will give rise to gradual emaciation; and this will be more marked and rapid the lower the region of the gut opened into.

In cases of indirect communication, the sudden bursting of an abscess into the bowel will be followed by relief of such symptoms as had been associated with the process of sup-

uration ; but, sooner or later, evidences of the communication will become manifest.

Fistulæ between the stomach and the external surface of the body arise in similar ways to those between the stomach and the intestine—either there is a direct ulcerative connection or there is the intermediate formation of an abscess. In addition there are fistulæ which are artificially produced ; that is to say, they result from an endeavour on the part of the surgeon to secure to the abdominal incision an ulcer which has perforated.

As regards the treatment of the former class of cases, i.e. where communication exists between the stomach and the bowels, I have been unable to find any instance of operative interference. There can be little doubt, however, that where the symptoms unmistakably point to a fistula and the patient's condition is one of gradual decline, an endeavour should be made to deal with it. What needs to be done can only be known after opening the abdomen and examining the affected region. Supposing it impossible to deal radically with the ulcer and with the intestine—that is to say, to excise the one and occlude the orifice of the other—it might be found possible to detach the intestine, refresh and suture the edges of the opening, and then to deal with the ulcer in one of the ways already described when excision is not feasible.

The treatment of a fistula which opens from the stomach on to the surface of the body by any operative procedure is questionable. In the first place, the fistula is of itself partly a curative measure. Complete cicatrisation of the ulcer and the stomach would be followed in all probability by a natural closure of the fistula ; but so long as there is any active process of destruction going on, the fistula is for the time being a guard against more serious troubles. The treatment must consist in endeavours to protect the skin from irritation around the external orifice. To prevent the escape of gastric contents a small pad must be kept over the opening ; or some mechanical contrivance employed, such as will be found in describing the methods of preventing leakage after gastrostomy.

CASE LIII.—*Gastric ulcer with gastro-colic sinus.*

A young woman aged 22 had always been subject to constipation, and three years previously had been attacked with sickness and vomiting,

which continued more or less frequently until she came under the notice of Dr. Gordon. Treatment at first gave relief, but after six weeks stercoraceous vomiting came on. She died from exhaustion. On post-mortem examination only, sufficient peritonitis was found to unite the peritoneal surface of the stomach to the transverse colon at the seat of the ulcer, thus preventing the gastric contents from passing into the peritoneal cavity when perforation took place through the sloughing of the base of the ulcer. The communication between the stomach and colon was circular in shape, three quarters of an inch in diameter, and situated in the posterior surface of the stomach two inches from the pylorus. There was an absence of hienteric stools throughout the whole progress of the case. (Gordon, 'Brit. Med. Journ.' 1892, vol. i. p. 229.)

6. *External adhesions.*—That adhesions may of themselves be a source of subsequent trouble in cases of gastric ulcer has been recently shown by a case brought before the Clinical Society of London by Mayo Robson.<sup>1</sup>

Sufficient has already been said of the way in which adhesions are contracted between the floor of the ulcer and some neighbouring part. The process is in most instances a protective one. Except for the adhesion of the stomach to some other part, perforation into the general peritoneal cavity would be a much more frequent occurrence than it is. The subject, however, of adhesions, which will be more fully discussed later, is introduced here as one which may prove a source of pain and annoyance to the patient after the cause which has given rise to them has been cured. The way in which these adhesions give rise to trouble seems to be either by unduly fixing the stomach so as to impair its proper motile function, or, by altering the relation of one part to another, to cause dilatation of the organ. The result as regards the patient's symptoms is the production of obscure abdominal pain accompanied with invalidism or debility, with no relief by any form of purely medical treatment.

The part of the stomach upon which adhesions are likely to produce the most marked effects is the pyloric region. Here the result is to cause some obstruction and consequent gastric dilatation.

That operation in certain cases is capable of giving complete and permanent relief is sufficiently well shown by Robson's case already referred to. In this instance the

<sup>1</sup> *Trans. Clin. Soc.* 1894 vol. xxvii. p. 1.



dilatation of the stomach, which had followed upon the obstructing influence of the adhesions at the pylorus, disappeared after separation of the latter. Krogius<sup>1</sup> also reports a case of successful laparotomy for the relief of serious and very painful symptoms caused by adhesion of the stomach to the abdominal wall after the healing of a gastric ulcer.

After all that has been said with regard to the curative effects of adhesions, the greatest caution will need to be exercised where operation is performed, and particularly so when no great interval exists between the symptoms of the pre-existent ulcer and the symptoms which are supposed to be due to the resultant adhesions. There is the possibility of so weakening the part by the separation of adhesions, that it will be liable to give way under strain. Sabrazès<sup>2</sup> records the case of an old ulcer which had contracted adhesion to a neighbouring part. The patient had indulged in a meal which had disagreed with him and provoked vomiting. The result was a rupture of the adhesions between the stomach and the liver, and the production of a large perforation. It should be remarked that when adhesions are separated by operation, an endeavour must be made to prevent a reunion of the disconnected parts. In the case of the pylorus this may be possible, but elsewhere it will be difficult.

7. *Internal contractions*.—The cicatrization of an ulcer may lead to considerable alteration in the shape of the cavity of the stomach. The more serious contractions are those in connection with the pylorus, which will be dealt with immediately; but when the body of the viscus is implicated, bands may be formed, or the cavity become narrowed. Some of the instances of so-called 'hour-glass' contractions are undoubtedly the result of cicatrization from ulceration. A specimen exists in Guy's Hospital Museum where an ulcer similar to that which has given rise to pyloric stenosis is present about the middle of the lesser curvature and has caused an 'hour-glass' contraction. Wölfler<sup>3</sup> also records a case of 'hour-glass' contraction due to this cause. The only practical interest connected with these constrictions is when

<sup>1</sup> *Centralblatt für Chirurgie*, 1896, No 22, p. 538.

<sup>2</sup> *Annual of the Universal Medical Sciences*, 1893, vol. i. C—12.

<sup>3</sup> *Brit. Med. Journ. Epitome*, 1895, vol. i. p. 30.

the surgeon has to discuss the method of treatment to be adopted in cases of perforation. In Parsons's case already quoted, the external circumference of the stomach at the seat of perforation appeared so small that no hope could be entertained of excising the ulcer completely without leaving too great a constriction. Wölfler, in his case of hour-glass contraction, opened the organ to the right and left of and below the scarred and contracted portion, and stitched the edges of the two orifices together so as to establish a free communication between the dilated cardiac and the dilated pyloric portions of the stomach (gastro-anastomosis). The patient made a good recovery. There are apparently no known symptoms specially associated with a stomach affected with internal contraction due to excessive cicatrisation, so long as the contractions interfere with neither the cardiac nor pyloric orifices.

8. *Pyloric stenosis*. — Considerable obstruction at the pylorus may be caused by an ulcer situated at or in the immediate vicinity of the pyloric orifice. This obstruction may be brought about in one of three ways: either it may result from the amount of inflammatory thickening which usually takes place around the ulcer, or from cicatricial contraction consequent upon the healing of the lesion, or from spasmodic closure. In the last instance, it is supposed that reflex contraction of the pylorus takes place as the result of irritation of the floor of the ulcer.

The symptoms which arise in connection with obstruction at the pylorus from gastric ulcer being more or less common to those which manifest themselves from other sources of obstruction, they will be dealt with under the general heading of that subject.

In like manner the subject of treatment will receive consideration under the same heading. It may be merely briefly indicated here that stenosis from gastric ulcer has been successfully treated by pylorotomy, digital dilatation (Loreta), pyloroplasty (Heineke-Mikulicz), and gastro-enterostomy.

## CHAPTER XXIV

## TUMOURS IN THE BODY OF THE STOMACH: INNOCENT; MALIGNANT

THE tumours intended to be discussed here are such as involve neither the pyloric nor the cardiac orifices, but find their seat in any part of the viscus between these two regions. As at the pylorus, the large majority of tumours implicating the body of the stomach are carcinomatous; a few instances are recorded of sarcoma; and only exceptionally tumours of an innocent character are met with. The interest of these tumours to the surgeon is mostly when they can be felt through the abdominal parietes, for unless a tumour can be thus detected externally, the symptoms are frequently so obscure that the case receives the attention rather of the physician than the surgeon.

**Innocent tumours.**—As examples of innocent tumours, which may or may not give rise to symptoms, may be mentioned lipomata, lipo-myomata, fibromata, myomata, fibromyomata, and lymphadenoids.

A specimen of a lipoma was shown at the Pathological Society of London by Murray.<sup>1</sup> Coats<sup>2</sup> also figures a tumour of the same structure about the size of a hazel nut. Pitt<sup>3</sup> showed, at the same Society, specimens of lymphadenoid growths in the mucous membrane of the stomach. One of these growths was an inch thick and two inches across. The patient had had no symptoms. Norman<sup>4</sup> reports a somewhat similar case. There had been entire absence of symptoms. ‘The mucous membrane was everywhere thickened, and presented all varieties of polyposis, from large dendriform projections to small wartlike growths.’ Other references to similar cases are given. A case of lipo-myoma is reported by Kunze.<sup>5</sup> A man aged 52 years had complained of pain in the middle of the abdomen for fourteen years. There had been no vomiting

<sup>1</sup> *Trans. Path. Soc. Lond.* 1889, vol. xl. p. 78.

<sup>2</sup> *Manual of Pathology*, 3rd edit. p. 287.

<sup>3</sup> *Trans. Path. Soc. Lond.* 1889, vol. xl. p. 80.

<sup>4</sup> *Dublin Journal of the Medical Sciences*, 1893, vol. xlv. p. 346.

<sup>5</sup> *Annual of the Universal Medical Sciences*, 1891, vol. i. C—10.

nor eructation. In the umbilical region a tumour as large as the fist could be felt, rough, movable in all directions, and with easily definable borders. The diagnosis made was tumour of the mesentery. On operation a tumour was found in the anterior wall of the stomach, at the cardiac end. Death occurred in fifteen days. Cleghorn<sup>1</sup> records the case of a fibroma or fibromyoma which existed in the form of a large polypus attached to the lower border of the stomach, about three inches from the pylorus. The patient's symptoms evidently depended upon its intermittent incarceration by the pyloric sphincter. Pathologists are acquainted with other forms of innocent growths, such as multiple adenomata, fibrous papillomata, pouches, and cysts, but these give rise to little or no distinctive symptoms, and are mostly discovered only after death.

Certain cases of solid tumours are occasionally met with which present the clinical features of malignancy, and yet spontaneously disappear. They are frequently described as solid tumours of the abdomen, without any special indication of the part or parts with which they may be connected, or from which they may arise. In some instances, however, the association of the tumour with some distinct region has been noted, and in these it has more frequently been with the intestines. In this connection they will be referred to later. In a case recorded by J. Crawford Renton,<sup>2</sup> the stomach was implicated in a large tumour which caused vomiting and emaciation. The abdomen was opened with a view to performing gastro-enterostomy, but the tumour was found so adherent that no operation could be performed. The diagnosis was malignant disease. Eighteen months afterwards, the patient was quite well; and the tumour, which before operation was felt as 'a hard nodular mass, extending all over the greater curvature of the stomach,' had entirely disappeared. The probable inflammatory nature of these tumours will be further discussed when treating of the same disease in the intestines.

**Malignant tumours.—Carcinoma.**—Carcinoma is met with in the body of the stomach in three forms: (1) cylinder-celled, (2) spheroidal-celled, and (3) colloid. The third form, however, merely represents a degenerative change in either of the

<sup>1</sup> *Annual of the Universal Medical Sciences*, 1893, vol. i. C—17.

<sup>2</sup> *Trans. Path. and Clin. Soc. Glasgow*, 1895, vol. v. p. 176.

preceding, but is more frequently found attacking the spheroidal-celled. The scirrhous and medullary varieties of carcinoma comprise both the spheroidal-celled and the cylinder-celled, inasmuch as fibrous tissue may enter very largely or very slightly into the structure of either of these forms. The tendency of all forms is to infiltrate and invade considerable areas of the stomach wall; the more circumscribed growths are usually the cylinder-celled. The true distinctions between the different forms of carcinoma are mostly determined by the microscope, but occasionally it is possible to distinguish them with the naked eye. Thus the colloid presents a somewhat gelatinous appearance, and the medullary tumour tends to invade the coats of the stomach and form projections externally.

**Diagnosis.**—It is not intended to discuss at any length here the symptoms of gastric carcinoma. It is never at the early stage that the surgeon meets with these cases; as already indicated, it is not usually until a tumour can be felt, and the question is raised as to its possible connections and likely nature. It may be incidentally remarked that the symptoms of gastric carcinoma are frequently so obscure that the physician is unable to give any assistance from the earlier history of the case. It sometimes happens that there is an entire absence of any gastric trouble, though there is extensive disease in the organ itself. A man was recently under my care in the infirmary suffering from chronic cystitis, for which he was being treated. He was suddenly taken with severe abdominal symptoms and died in a few hours. At the post mortem, extensive carcinoma of the stomach was found, with at one spot an ulcerative perforation. During his residence in hospital he had never shown any symptoms of his gastric complaint. Numerous somewhat similar cases have been recorded, where the most extreme disease has been found after death, yet during life, or up to a comparatively short time before death, there has been an entire absence of any indication of the stomach mischief. There is one symptom of considerable importance to which attention has been forcibly drawn in recent years. It is found that with comparatively few exceptions hydrochloric acid is absent from the gastric juice in carcinoma of the stomach. The reason of this Mathieu<sup>1</sup>

<sup>1</sup> *Archives Générales de Médecine*, 1889, vol. i. p. 402.

attributes to an interstitial gastritis with atrophy of a considerable number of glands. These changes exist not only at the seat of growth, but at a distance from it. In a case of my own, the disease was limited to the pylorus, but with Günz-burg's solution no reaction of free hydrochloric acid was obtained. In explanation of those cases where HCl is found, it is supposed that there still remains some healthy secreting mucous membrane. (For description of method of examination see page 150.)

In some instances, though rarely, the supraclavicular lymphatic glands are found enlarged. Troisier<sup>1</sup> points out that the glands of the left side are more often affected than those on the right.

The features regarding a tumour of the body of the stomach, when it can be felt, will be, in the first place, its situation. It will be located more or less in the epigastric region, extending, according to its dimensions or according to the extent of the stomach involved, to either side or below this region. It will sometimes be found to ascend and descend in respiration, and to alter its position according to the degree of distension of the stomach. It may be hard and painless to the touch, and capable of a certain amount of movement by manipulation. These few points present no degree of certainty in themselves, but existing in conjunction with others will materially assist towards a correct diagnosis. In a case reported by Franks,<sup>2</sup> a tumour hard and tolerably movable was felt in the epigastrium which moved upwards and downwards on respiration. It was not tender on pressure. On exploring, a large tumour was at once exposed, which proved to be a colloid carcinoma involving the whole thickness of the stomach walls, and to almost their whole extent.

The course which the disease may take varies. In most instances death sooner or later ensues from the emaciation and exhaustion due to an increasingly disordered digestion. In other cases some serious complication may hasten the end. Where ulceration is in process, a severe and fatal hæmorrhage may occur; or, as in my case, ulceration may lead to per-

<sup>1</sup> *Gazette Hebdom. de Méd. et de Chir.* 1886, p. 683.

<sup>2</sup> *Trans. Acad. Med. Ireland*, 1887, vol. v. p. 246.

PLATE IX.

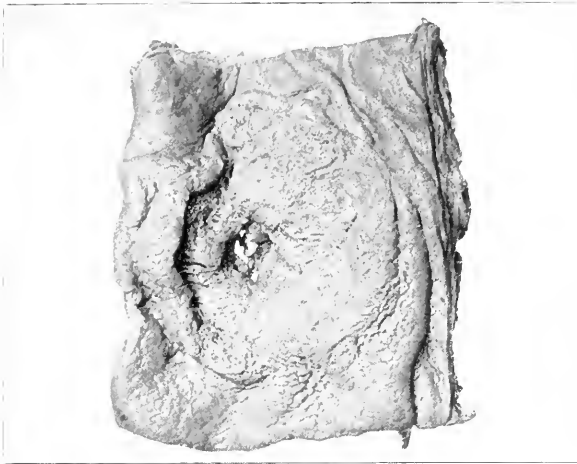

Fig. 16.—CARCINOMA OF STOMACH.—The ulcer is circular in form, and the walls around are infiltrated. (W.L.M., Glas.)



Fig. 17.—CARCINOMA OF STOMACH.—The ulcer is situated in the lesser curvature about two inches from the pylorus. The existence of the ulcer was not suspected during life. (R.L.M., Glas.)





foration. In a case recorded by Ducheneau,<sup>1</sup> adhesions formed between the tumour and the abdominal parietes; the latter gave way at the umbilicus, and the discharge which took place led to the belief that it was simply an umbilical abscess. A somewhat similar complication is recorded by Fräntzel.<sup>2</sup> An abscess formed the indirect connection between the tumour and the parietes. This abscess, when opened, contained ichorous, foul-smelling pus mixed with air bubbles, the latter being freely expelled when the patient coughed. West<sup>3</sup> reports a case where adhesion formed between the stomach and the colon, and by ulceration a communication was established between the two. In this case the patient showed no symptoms until six weeks before death. A similar complication occurred in a case recorded by May.<sup>4</sup> The patient took meat in large quantities and digested it. At no time were the stools lenteric in character. The man lived four months. The nature of the case was diagnosed during life from the escape of gas into the stomach after injection into the colon; also, that in washing out the stomach with cool water, the water was at once ejected *per rectum* at the same temperature.

**Treatment.**—There is little to suggest in the way of treatment from the purely surgical point of view. After the surgeon has opened the abdomen and ascertained the nature of the tumour and its connections he will in all probability find that any consideration of removal is out of the question. One of the most marked features of carcinoma of the body of the stomach is its tendency to extensive invasion of the walls. The fact of being able to feel the growth through the abdominal parietes almost necessarily implies that the walls of the viscus have already become so extensively infiltrated that total removal will be impossible. Could such localised lesions as are shown in Plate IX be diagnosed, it might reasonably be expected that removal would be easy and a cure possible. The remarkable success of very extensive removal by Langenbuch<sup>5</sup> must be mentioned, if only to show what it is possible to accomplish. About seven-eighths of the stomach were removed,

<sup>1</sup> *Annual of the Universal Medical Sciences*, 1889, vol. i. C—24.

<sup>2</sup> *Ibid.*

<sup>3</sup> *Trans. Path. Soc. Lond.* 1890, vol. xli. p. 97.

<sup>4</sup> *Annual of the Universal Medical Sciences*, 1891, vol. i. D—10.

<sup>5</sup> *Brit. Med. Journ. Epitome*, 1895, vol. i. p. 11.

and the two ends united after the necessary narrowing of the cardiac extremity. The stomach then had the size of a hen's egg. The patient made a good recovery. A second case was attempted, but the stomach proved so friable that it tore during the removal. The patient succumbed on the sixth day, death resulting apparently from deficient nutrition rather than from any untoward result connected directly with the operation. The only palliative measure—if an operation may be so designated—is the performance of duodenostomy or jejunostomy, whereby the patient may be fed by the bowel, and so any troublesome symptoms dependent upon gastric ingestion relieved.

**Sarcoma.**—As compared with carcinoma, this is a rare disease of the body of the stomach. In an examination of fifty specimens of malignant diseases of the stomach by Perry and Shaw,<sup>1</sup> only four were found in which the tumour was a sarcoma, and in each of these the pyloric region was principally affected, the disease spreading towards the body of the organ. Billroth's<sup>2</sup> well-known case consisted of an enormous cystic sarcoma attached to the greater curvature of the stomach and implicating also the lower part of the anterior and posterior walls. It was successfully removed. Hadden<sup>3</sup> exhibited a specimen at the Pathological Society of London of a lympho-sarcoma. It consisted of a globular tumour connected with the anterior wall of the stomach close to the lesser curvature and rather nearer the pyloric than the cardiac orifice. Handford<sup>4</sup> also showed, at the same Society, a specimen of diffuse sarcoma of the stomach. The wall of the viscus was diffusely infiltrated, there being an absence of any sharply defined tumour. Ebstein<sup>5</sup> reports a case of rapidly growing sarcoma in a man aged 22 years: 'secondary nodules were found in the peritoneum and in one of the kidneys; a degenerated sarcomatous mass was situated between the right auricle and right ventricle.' Hartley<sup>6</sup> recorded a case in which he

<sup>1</sup> *Guy's Hospital Reports*, 1891, 3rd series, vol. xxxiii. p. 137.

<sup>2</sup> *Wiener Med. Wochenschrift*, 1888, vol. xxviii. p. 105.

<sup>3</sup> *Trans. Path. Soc. Lond.* 1886, vol. xxxvii. p. 234.

<sup>4</sup> *Ibid.* 1889, vol. xl. p. 89.

<sup>5</sup> *Annual of the Universal Medical Sciences*, 1894, vol. i. C—22.

<sup>6</sup> *Annals of Surgery*, 1896, vol. xxiii. p. 609.

successfully removed from the posterior wall of the stomach a spindle celled sarcoma. The patient's chief symptom was the occasional vomiting of large quantities of blood.

As regards diagnosis and treatment, there is but little to add to what has already been said in connection with carcinoma of the organ. From the fact of sarcomata being more localised in their involvement of the gastric walls, removal by excision may be considered; and, as shown by Billroth's case and by Hartley's, the operation may be followed by success. In most instances, however, it is only too likely that no clinical distinction will be possible; and that the growth is a sarcoma and not a carcinoma will be a matter that can only be subsequently settled by the pathologist.

---

## CHAPTER XXV

### OBSTRUCTION AT THE CARDIAC AND PYLORIC ORIFICES

**Cardiac obstruction.**—Obstruction at the cardiac orifice has already been fully discussed under the heading of (Esophageal Obstruction; and it is only intended to refer here to stenosis, which has its origin in disease strictly within the stomach. Hilton Fagge held somewhat strongly to the opinion that carcinoma did not arise at the cardiac end of the stomach, that when found there it was really connected with the lower end of the œsophagus; in other words, it was an extension downwards from the gullet. Perry and Shaw point out that probably the true determining feature is to be found in the histological character of the growth. Inasmuch as, they say, every growth of a carcinomatous character in the gullet is composed of squamous cells, the structure of the tumour being found to be either spheroidal or cylinder-celled would prove its gastric origin. Against the absolute truth of any such distinction is the fact that rare instances have been recorded of cylinder-celled carcinoma of the œsophagus (see page 62). Steven<sup>1</sup> has reported a case of tumour arising at the cardiac orifice. The growth was a diffuse colloid and columnar-celled epithelioma, which apparently had its origin around the entrance of the œsophagus and spread over the

<sup>1</sup> *Glasgow Med. Journ.* 1888, N.S. vol. xxx. p. 457.

anterior and posterior walls of the stomach. In cases of obstruction at the cardiac orifice, the disease is more likely to be of gastric than œsophageal origin, when the walls of the stomach are considerably invaded. The point is of some practical importance in connection with the question of treatment. Where the disease has invaded the stomach, the operation of gastrostomy may not be possible, nor that of gastro-enterostomy; while on the other hand duodenostomy or jejunostomy will need to be practised. Jessett<sup>1</sup> reports having successfully operated on two cases by jejunostomy. In both these the disease had extended too far over the anterior walls to admit of any operation on the organ itself. In cases upon which it is found possible to perform a gastrostomy the tube for feeding purposes should, as suggested by Ewald, pass through the pylorus; the reason for this being the possibly disorganised condition of the stomach for all digestive purposes. Whether resection of the cardiac orifice will ever come within the field of practical surgery, time alone can prove. Suffice it to say that Levy and Fehleisen<sup>2</sup> have recently devised such an operation.

The symptoms connected with obstruction at the cardiac orifice are in all points similar to those where the disease is more strictly œsophageal. Only at an early stage it may be sometimes possible, from the existence of gastric symptoms, to connect the origin of the disease with the stomach rather than the œsophagus.

**Pyloric obstruction.**—As a disease, obstruction at the pylorus far outnumbers all other malignant affections of the body or cardiac orifice of the stomach. While the cause of obstruction may sometimes be obscure, the symptoms are almost always unmistakable, and the changes which sooner or later follow in the organ itself are usually equally clear.

*Causes of pyloric obstruction.*—The various causes which give rise to obstruction at the pyloric orifice may be primarily divided into those which act from without and are independent of the pylorus, and those which are organically connected with the stomach.

*Obstruction from without.*—Any tumour arising from the

<sup>1</sup> *Surgical Diseases of the Stomach and Intestines*, p. 64.

<sup>2</sup> *Centralblatt für Chirurgie*, 1894, No. 31, p. 721.

pancreas, liver, omentum, mesenteric or retroperitoneal glands may press upon and obstruct the orifice. Similarly aneurysm of the aorta or coeliac axis, and hydatid cysts. Ewald<sup>1</sup> quotes a case reported by Minkowski, where a gall stone distended the gall bladder and completely occluded the pylorus by pressure, producing enormous dilatation of the stomach. Cicatricial bands arising from previous inflammatory mischief in the neighbourhood of the pylorus may cause constriction. A somewhat unusual cause of obstruction is reported by Taylor.<sup>2</sup> The patient had all the usual symptoms, and when gastrotomy was performed to ascertain the nature of the obstruction, it was found that the pylorus was kinked. The patient made a perfect recovery, and the author attributes the success of the operation to the adhesions which subsequently developed between the stomach incision and the abdominal parietes, whereby the dilated viscus was somewhat raised.

*Obstruction from conditions directly connected with the pylorus.*—By far the larger number of cases of obstruction owe their origin to some cause organically connected with the pylorus. The commonest cause is carcinoma, which obstructs either by the thickening it produces in the walls of the orifice, or by warty, villous, or nodular projections into its canal. With rare exceptions the disease never passes beyond the pylorus into the duodenum; on the other hand the fundus of the stomach may be extensively invaded. The form of carcinoma is either the spheroidal-celled or the cylinder-celled. The former sometimes assumes the typically scirrhus character. It is now generally believed that many cases, which were at one time supposed to be non-malignant fibrous thickening of the pylorus, are forms of scirrhus carcinoma. Microscopically little else than fibrous tissue is found; but when enlarged lymphatic glands are examined, the presence of epithelial cells demonstrates the true nature of the induration. Cases of sarcoma of the pylorus are much more rarely met with. Perry and Shaw, in their list of fifty cases, record two instances. In both these the tumour was a round-celled sarcoma, and extended for a short distance into the duo-

<sup>1</sup> *Lectures on Diseases of the Stomach*, New Sydenham Society, 1892, vol. ii. p. 335.

<sup>2</sup> *Lancet*, 1891, vol. i. p. 983.

denum, differing in this respect from the carcinomata. As already indicated, obstruction may be caused by a simple gastric ulcer. Inflammatory thickening around a progressive ulceration may cause considerable narrowing of the canal, and the same result may take place from the cicatrisation of the ulcer in the process of healing. Bond<sup>1</sup> records an instance of obstruction due to a state of chronic reflex spasmodic contraction of the part, the primary seat of irritation being a large ulcer. A true fibrous stricture may result from irritant poisoning.

Among exceptional causes of obstruction may be instanced one recorded by Pernice<sup>2</sup> of a large myoma; and another by Perlik<sup>3</sup> of a diverticulum when filled with chyme. Hale White<sup>4</sup> records an instance of thickening of the pylorus due to the irritation of a gall stone, which ulcerated from an adherent gall bladder through the pylorus into the stomach. Lastly there are cases of congenital stenosis.

**Symptoms.**—Obstruction at the pylorus, from whatever cause, manifests itself insidiously. The earlier symptoms are those connected with some gastric disturbance. The contents of the stomach being unable to obtain a free exit through the pylorus, are thrown back again upon the gastric cavity, with the result that the mucous membrane soon suffers and normal digestion no longer takes place. This disorganisation of the proper function of the stomach soon manifests itself in various dyspeptic symptoms. The patient complains of discomfort in taking food, a feeling of fulness or weight in the region of the epigastrium, a sense of nausea, with furred tongue and foul breath. Want of appetite and a tendency to refrain from food are seen in those cases where much pain is associated with ingestion. In other instances there is a craving for food, and the stomach is so tolerant of its presence that large quantities accumulate before being ejected. Tenderness may be experienced when pressure is made over the stomach. Headache, depression, and other neurotic symptoms may be present.

As the obstruction becomes more marked, the various

<sup>1</sup> *Brit. Med. Journ.* 1889, vol. ii. p. 1323.

<sup>2</sup> *Annual of the Universal Medical Sciences*, 1892, vol. i. C—15.

<sup>3</sup> Ewald, p. 329.

<sup>4</sup> *Trans. Path. Soc. Lond.* 1886, vol. xxxvii. p. 280.

symptoms become exaggerated, and constant vomiting, either immediately after food or at variable periods later, soon becomes a prominent feature. Coincident with these symptoms is a gradual falling off in body weight and strength. Constipation causes much annoyance and discomfort. When that stage is reached in which the stomach begins to lose the power of returning its contents, vomiting becomes less frequent, fermentation of the retained food grows more active, and the viscus may get so distended with gas that it presses upon the heart and lungs, and the patient becomes distressed both by palpitation and dyspnoea.

CASE LIV.—*Carcinoma of the pylorus.*

Mrs. L., aged 57 years, was admitted to the Victoria Infirmary, Glasgow, on February 2, 1894, under the care of Mr. Maylard. Her symptoms commenced about fifteen months before admission to the hospital. At this time her most prominent trouble was the pain experienced after taking food, and so much annoyance did it cause that she was afraid to eat anything. She would also occasionally vomit, the contents of the stomach consisting of but slightly altered food. No blood was observed, but she states that her stools were sometimes almost black. On admission to the infirmary she was found to be greatly emaciated. She took food, which lay like a load on her stomach for some hours; it then 'soured,' causing eructations of sour gas and fluid, and finally was thrown up in large quantity. Palpation of the abdomen gave evidence of a tumour in the epigastric region just beneath the ribs on the right side; it was movable from above downwards and also from side to side. Succussion produced a splashing sound. A 'test breakfast' was administered, and after removal and examination with Günzburg's reagent, revealed no evidence of free hydrochloric acid. Gastro-enterostomy was performed. The patient died on the ninth day from inanition, the result of a gastric fistula, through which everything given by the mouth passed out. At the post mortem, the pylorus was found to barely admit the tip of the little finger. No secondary deposits were found in the liver, spleen, or kidneys. No enlargement of lymphatic glands. Microscopically the tumour was a cylinder-celled carcinoma. (A. Ernest Maylard, Clinical Reports, 1894.)

CASE LV.—*Carcinoma of the pylorus.*

R. H., aged 50 years, was admitted into the Victoria Infirmary, Glasgow, on May 9, 1894, under the care of Mr. Maylard. His symptoms had commenced about eight months previously. At that time he felt some vague discomfort in taking his food, and frequently would refrain from doing so until he reached home after his day's work. He would then indulge in a heavy meal. At this early period vomiting only occurred occasionally. For the last three months his appetite had been ravenous. Food was retained for a couple of days or longer, and then

followed vomiting of an enormous quantity of more or less fluid and very sour-smelling material. In his own words, he would sometimes bring up a 'basinful' His bowels since the commencement of his illness have been irregular and very constipated. Pain has never been a feature in his case. On admission the patient was in an extreme state of weakness and emaciation. The abdomen was much sunken, and an examination of the region revealed an ill-defined sense of resistance in the region of the pylorus. When warm water was run into the stomach through a siphon tube, the stomach was seen to distend, and the greater curvature could be easily defined as it extended some two or more inches below the umbilicus. The usual test breakfast given, no evidence of free hydrochloric acid could be obtained. Gastro-enterostomy was performed, but the patient died on the fourth day. From the time of the operation no urine was secreted. At the post mortem there was evidence of peritonitis in the region of the stomach, but the union between the bowel and the stomach was complete. The pyloric stenosis was so tight that only a No. 6 catheter could be passed. Microscopical examination of the pylorus showed it to be affected with scirrhus carcinoma. (A. Ernest Maylard, *Clinical Reports*, 1894.)

**Diagnosis.**—It is not usual, until vomiting has become a frequent and prominent symptom, that pyloric stenosis is one of the causes thought of. The early dyspeptic symptoms, while sufficiently marked of themselves, are too suggestive of so many other causes to be of any specially diagnostic value. By the time vomiting has proved itself an intractable and constant symptom, two other conditions may have sufficiently developed to aid materially in arriving at a correct diagnosis. The first of these is the existence of a tumour in the epigastric or right hypochondriac region; and the second, dilatation of the stomach.

There is nothing markedly characteristic in the tumour. Its size and mobility depend upon its nature and amount of fixation. In cases of a long gastro-hepatic omentum, or of a comparatively firm solid tumour, it may be freely moved in all directions; and in cases of very thin abdominal walls, it can be almost grasped with the finger and raised. Where the opposite conditions exist, the tumour may be so bound down and confined beneath the right lobe of the liver that it cannot be palpated. Material assistance will be obtained in determining these various features of the tumour by the administration of an anæsthetic. Supposing a tumour can be felt, it will in the majority of instances indicate either the thickening due to a gastric ulcer or to malignant disease, and



PLATE X.



Fig. 18.—CARCINOMA OF PYLORUS.—The lesser curvature has been encroached upon and drawn in; the body of the stomach is much dilated. (*W.I.M., Glas.*)



there is nothing in the nature of the tumour so felt that will help to distinguish the one from the other.

As already indicated in discussing the subject of carcinoma of the body of the stomach, much importance has been attached, from a diagnostic point of view, to the existence or non-existence of free hydrochloric acid in the gastric contents as a means of distinguishing cases of ulcer from those of malignant disease. In the former the acid is present and often in excess, while in the latter it is most commonly absent. In all cases therefore a careful examination of the contents of the stomach should be made. (See page 150.)

The dilatation of the stomach which follows upon any form of obstruction at the pylorus is important in so far as it helps to support the correctness of the diagnosis. There is, however, considerable difficulty in determining such dilatation in all except the most marked instances. In the first place there is considerable variation in the normal size and capacity of the stomach, and in the second the methods at our disposal are far from giving any very certain results. An endeavour, however, must be made to ascertain, if possible, the amount of dilatation present; for not only is it important from a diagnostic point of view, but it is a material advantage to the surgeon to know, in view of any operation, whether or not he has a dilated viscus to deal with.

To avoid repetition here, the reader is referred to the section on physical examination of the stomach, where the methods of inspection, palpation, auscultation, and inflation necessary to be employed in these cases are fully described. (See page 153.)

It may, however, be briefly pointed out that where a patient is known to retain his food for twenty-four hours or longer, and then bring up some very large quantity—a ‘basinful’ as it is sometimes expressed—there can be very little doubt of the dilated condition of the stomach. Further, the extreme emaciation which so often exists, and the sunken state of the abdominal parietes, admit of a visible projection of the stomach as it is slowly distended with water allowed to flow in through a tube. The quantity which can thus be introduced, and the level down to which the greater curvature extends below the umbilicus, will assist in conveying some notion of

the amount of dilatation present. In some cases a marked peristaltic action of the stomach walls is seen. The stomach appears and disappears like a phantom tumour. These movements may be taken as pathognomonic of obstruction at the pylorus.

Splashing on succussion is often present, and usually indicates some amount of dilatation.

The diagnosis of the rarer causes of pyloric obstruction can in most instances only be conjectural. With the exception of such forms of stenosis as can be traced to the imbibition at some antecedent date of a corrosive or irritant poison, it is not possible prior to an operation to ascertain the true nature of the obstructing agent.

**Treatment.**—It is impossible by any other measures than those which are purely surgical to deal with organic obstruction at the pylorus. It is true that much may be done by such palliative measures as washing out the stomach and careful attention to diet, but these only alleviate for a time. Sooner or later the patient must sink from inanition. If surgical interference is to be entertained, the question of most moment is, how long are these palliative measures to be continued before some radical attempt is made to overcome the obstruction? The custom of the past has been to delay anything operative until the patient is practically *in extremis*. The practice of the future will be to operate so soon as a reasonable diagnosis is arrived at. The results of such early operations will be first to subject the patient to an operation from which he will have a much greater chance of immediate recovery; second, to prolong life beyond what it would otherwise have reached; and lastly, to give a chance of a permanent recovery. No statistics based on past experience can convey any adequate impression of what may be hoped for in the future. Every surgeon's retrospect is more or less a gloomy one. He mostly recalls cases where the patient seemed already to have one leg in the grave, and his operation consisted simply in helping in the other. But no such gloomy prospect need exist for the future, if only these cases are taken early enough: when the patient has a sufficient store of strength to draw upon, and his recuperative powers are not just on the verge of extinction.

The kind of operation to be performed depends upon the nature of the obstruction. In cases of cicatricial stenosis such as result from traumatism, corrosive poisoning, and ulceration, the pylorus may be digitally dilated as by Loreta's method, or divided longitudinally and stitched transversely as by the Heineke-Mikulicz operation of pyloroplasty. In cases of malignant tumour the operation selected will depend upon the extent of the disease and its connections with adjacent parts. For a freely movable and moderately localised growth pylorotomy, or this operation in conjunction with gastro-enterostomy, may be performed. Where removal does not seem feasible, either from the extent of the disease in the stomach or from its involvement of neighbouring parts such as the omentum and pancreas, gastro-enterostomy, duodenostomy, or jejunostomy may be performed. In substitution of these latter operations a preliminary gastrostomy may be performed, and a tube then gently passed through the pylorus, and the patient fed directly into the duodenum. A more radical measure than this last has been performed successfully by Bernays, who after completing gastrostomy scraped away as much as possible of the obstructing tumour, and so established a free communication between the stomach and the duodenum.

For the details regarding the performance of these operations the reader is referred to the chapters at the end of each section on diseases of the stomach and of the intestines respectively; but there are certain general preparations to be made before, and details to be attended to after, operation, which may be properly considered here.

*Before operation.*—The stomach should be washed out with warm water. If dilatation be marked it is better to wash out daily for a week previously. Under ordinary circumstances the day before and the morning of the operation will be sufficient. The washing ought to be efficiently done, and in my own experience nothing answers better, when it can be passed, than a fair-sized ordinary rubber tube with a large oval opening cut in it quite close to its terminal orifice. The other end is attached to a funnel or filler, which when raised slightly above the patient's head, allows the fluid to flow in slowly. To remove the fluid the filler is lowered below the level of the bed and the patient requested to voluntarily express it. This

can be repeated two or three times until the fluid returned is clear. The voluntary propulsion on the part of the patient tends to get rid of all the fluid better than any mechanical suction. In cases, however, of greatly dilated stomach, the voluntary effort on the part of the patient is not sufficient, and the pump must be used. When, from excessive sensitiveness of the pharynx and gullet, retching is readily evoked by the introduction of the tube, the soft rubber one will not answer, for the pressure requisite to get it down causes it to double up in the pharynx and interfere with respiration. In these cases, therefore, it is necessary to use the ordinary stomach-pump tube, which possesses the requisite amount of rigidity.

The rectum should be well cleared of any fæces, in order to place it in the best condition for the reception of nutrient enemata. It is a wise course to administer a nutrient enema containing an ounce or two of brandy just prior to the operation.

The abdominal skin should be properly cleansed. The extreme emaciation which the patients have generally undergone makes them all the more susceptible to changes of temperature. Hence every precaution should be taken to maintain the warmth of the body. The arms, upper part of chest, and legs should be well covered with woollen garments. In the room where the operation is to be performed every consideration should be given to the warmth of the room itself, and of everything to be used at the operation. With the same object the operation should be as expeditiously performed as possible.

*After operation.*—The sum total of all after-treatment consists in giving the patient and the parts operated upon complete rest. In hospital these cases should be placed in a separate apartment, and nursed by a special nurse day and night. Quietness is conducive to sleep, and sleep to repair. In cases where pain is complained of, it is felt to a very variable extent. In cases that do well it is never very severe. Hypodermic injections of morphia ( $\frac{1}{8}$  or  $\frac{1}{4}$  grain) should be given, and repeated if required. Much inconvenience is often felt by the patient during the first night or two from being kept in the supine position. More good is gained by turning

the patient slightly to one side, and maintaining the position for a time by propping with a pillow, than by preventing rest and repose by rigidly enforcing the dorsal position. The knees should be kept flexed, to relieve any tension on the abdominal parietes. Chloroform sickness is always an unwelcome and somewhat dangerous sequel to the operation, and unfortunately little or nothing can be done to stop it.

The question of nourishment is of the utmost moment. It may be said to increase in importance in proportion to the degree of emaciation which exists at the time of operation. For rapidity of healing, complete rest of the wounded parts is essential; and this applies more particularly to operations which involve the accurate stitching of one viscus to another. When therefore the patient's strength will admit, all nourishment for the first forty-eight hours should be by nutrient enemata, and nothing should be administered by the mouth, except a little ice for the purpose of moistening the tongue and fauces. The longer this method of nutrition can be maintained the better. Where, however, it is seen that the patient's strength is likely to fail unless food be given by the stomach, it must be so administered. Food has been given without harm in cases of gastro-enterostomy almost immediately after operation. Jessett<sup>1</sup> states that in the three successful cases of gastro-enterostomy which he has had, he has commenced to feed at once; and argues that if the union be perfect there can be no harm in doing so.<sup>2</sup> Many cases, however, have been recorded where, through strain from vomiting and other causes, stitches have given way. It is therefore much wiser, so long as the patient's strength seems sufficient, to enjoin perfect rest to the stomach by administering all nourishment *per rectum*. Food when first taken by mouth, whether early or late in the treatment, should be of a bland, nutritious, and easily digestible nature. Milk will form the staple diet, but to it may be added finely ground farinaceous materials. In like manner nitrogenous food, such

<sup>1</sup> *Medical Press and Circular*, 1891, N.S. vol. li. p. 581.

<sup>2</sup> NOTE.—A reference to these cases, as reported in the *Clinical Society's Transactions* (1892, vol. xxv. p. 106), shows that a little water only was given on the first day, and not till the following or second day was a little food given in the way of peptonised milk.

as boiled fish and boiled fowl, should be administered in a finely divided or triturated state, and the latter mixed with the broth in which it is cooked. For suitable enemata, reference should be made to Chapter LXXXIV, where various kinds are given.

The urine will in most cases need to be withdrawn by catheter.

---

## CHAPTER XXVI

### PYLORIC OBSTRUCTION. TREATMENT (*continued*)

**Prognosis in respect to the different operations**—So much depends upon the strength of the patient at the time of the operation, that statistics cannot be said to have much value. A patient who from excessive inanition dies shortly after the operation ought not to count as a fatal result due to the operation. Speaking in a general way, an operation is severe in proportion to the time it takes to perform it. Experience forcibly teaches the truth that a very long operation is a very fatal one. An excision of the pylorus, which is usually a comparatively long operation, is a much more fatal one than gastro-enterostomy. An operation, however, which seeks to extirpate the disease ranks incomparably higher than one which only aims at alleviating for a time the patient's sufferings.

In discussing the relative merits of the two operations of pylorotomy and gastro-enterostomy in the treatment of malignant disease, due regard must first be had to the respective intents of the operations. The triple object of the former operation is to remove the obstruction, to re-establish the normal passage, and to extirpate the disease. The latter effects a similar result as regards the first two objects, only in another way, while it leaves the disease untouched. The radical distinction therefore between the two operations is that one seeks to extirpate the disease, while the other leaves it to take its course. But, inasmuch as the severity of the operation of pylorotomy is in the hands of most operators so much greater than that of gastro-enterostomy, it is a proper question to ask, how far excision of the pylorus does effect this result.

An interesting and instructive paper was published by



J. Lindsay Steven, in the 'British Medical Journal,'<sup>1</sup> dealing with the operative treatment of gastric carcinoma, and more particularly with pyloric disease. Steven based his remarks on nineteen post-mortem cases of carcinoma of the stomach, comprising twelve of the pylorus, six of the body of the stomach, and one of the cardiac orifice. In fourteen out of these nineteen, cases the liver was involved either alone or with other parts, and secondary nodules were noticed in parts other than the liver in two cases, giving therefore secondary complications in sixteen out of nineteen. In thirteen out of the nineteen, adhesions were present. In eighteen out of the nineteen the post mortems were upon patients who had died from the natural progress of the disease. The inference which Steven draws from these statistics is that operations upon the stomach for the removal of the disease can but rarely effect such a result. It need hardly be pointed out that the reasoning here is based solely upon pathological data and without distinction as to the situation of the growth. Thus as an argument against the advantage of attempting extirpation, presumably for pyloric stenosis, the author instances one case particularly, where the first symptoms appeared only four weeks before admission; and at the post mortem—death having occurred about two weeks after admission—the liver, which was three times its normal weight, was infiltrated in every part by secondary formations. A large ulcerated cancerous tumour was discovered near the pyloric region. It will be observed that this was not a case of pyloric stenosis, but one essentially of disease of the body of the stomach, an example of a class of cases totally distinct in all their features, both clinical and pathological, from malignant disease of the pylorus. In pyloric stenosis, symptoms, although often very obscure, always appear months before the disease produces death; and hence, however extensive the secondary formations which the pathologist may find at the post mortem, it is reasonable to suppose that these may not be in existence at the earliest manifestation of the disease. The practical teaching of these statistics is that it is useless to perform such an operation as pylorectomy with the intention of extirpating the disease when the patient

<sup>1</sup> 1892, vol. i. p. 845.

is already on the point of dying from it. If radical measures are to be attempted, it must be when the disease is detected early in its course, and not after it has almost concluded it.

Pylorectomy must always be considered a serious operation, but its relative severity will be greatly diminished when the patient is in a comparatively well-nourished condition. Considering the operation as practised in the past, Hahn<sup>1</sup> gives the following statistics. Up to the year 1885, 72 cases had been operated upon for carcinoma and 10 for cicatrisation, with a percentage mortality of 77 in the former and 60 in the latter. From 1885 to 1891, 34 cases for carcinoma and 4 for cicatrisation, with a percentage mortality of 41 for the former and 25 for the latter. This shows that experience alone has materially reduced the death rate from the operation. A much greater reduction is still more likely to ensue when the operation is performed at the earliest possible period of the disease. The statistics of Guinard<sup>2</sup> tell a somewhat similar tale. Up to 1881 he found a mortality of 71·43; while since 1887 it has been reduced to 52·23. In four cases in which Murphy's<sup>3</sup> button was used there were three deaths.

The risks of the operation have to be put against the length of time which the patient is likely to live without it; but against this must also be placed the possible prolongation to life which this operation and no other can afford. James A. Adams,<sup>4</sup> in recording a successful case of pylorectomy, in which he accomplished the entire operation by using the continuous suture in the short space of time of an hour, refers to a case of Wölfler's, where the patient lived in comfort for five and a half years: to one of Kocher's, where after five and a half years the patient was still in the enjoyment of perfect health; and to one of Rydygier's, where the patient lived for two and a half years. It must therefore generally be a matter for the patient to decide, after hearing the honest opinion of the surgeon, whether he is prepared to face the risks of the operation for such benefits as are possibly

<sup>1</sup> *Berliner klin. Wochenschrift*, 1891, p. 853.

<sup>2</sup> *Cancer de l'Estomac*, p. 104.

<sup>3</sup> *Lancet*, Murphy's tables, 1895, vol. i. p. 1041.

<sup>4</sup> *Glasgow Med. Journ.* 1896, vol. xlv. p. 114.

to be obtained from it. If excision of the pylorus is to have an established place in surgery, it will be for early and not late cases. For the latter, palliative measures alone can be attempted; and of these gastro-jejunostomy is most likely to find greatest favour.

**Gastro-enterostomy.**—The operation, first performed by Wölfler in 1881, is a serious one and frequently fatal; but if pylorotomy is to be restricted to early cases, and it to later, gastro-enterostomy has this advantage in comparison with the former, that when death does result, the patient's life may not have been shortened by more than a week or two. Of 17 cases collected by Jessett,<sup>1</sup> there were 5 deaths, giving a mortality of 30 per cent. Two cases died from closure of the opening, one four months and the other five months after the operation. In illustration of the value of using absorbable plates, Magill<sup>2</sup> has collected 61 cases so treated, with 14 deaths, thus giving a mortality of 22·95 per cent. As indicated by Guinard,<sup>3</sup> the success of this operation has varied considerably in the hands of particular surgeons. Thus Billroth had 2 successes out of 6 cases—a percentage mortality of 66·66; Rydygier was successful with 3 out of 4 cases—a percentage mortality of 25; Lauenstein lost only 2 cases out of 9—a percentage mortality of 22; Czerny lost 7 out of 11 cases—a percentage mortality of 63·63; Angerer lost 5 out of 6—a percentage mortality of 83·33; and Lücke lost only 1 case out of 8—a percentage mortality of 12·5. The most recent statistics are those by Murphy,<sup>4</sup> where out of 26 cases in which his 'button' was employed by different operators there were 8 deaths—a percentage of 30·7.

The combined operation of **Pylorotomy** and **Gastro-enterostomy**, performed first by Billroth in 1885, has for its object the removal of the disease, and the easier establishment of a communication between the stomach and the bowel. The operation, although a severe one, has not been altogether unsuccessful. It has been successfully performed by Billroth,

<sup>1</sup> *Trans. Clin. Soc. Lond.* 1892, vol. xxv. p. 106.

<sup>2</sup> *Annals of Surgery*, 1894, part xxi. p. 313.

<sup>3</sup> *Cancer de l'Estomac*, p. 109.

<sup>4</sup> *Lancet*, Murphy's tables, 1895, vol. i. p. 1015.

Bull,<sup>1</sup> Jessett,<sup>2</sup> and Ferguson;<sup>3</sup> and unsuccessfully by Lawson, and by Greig Smith.<sup>4</sup> It is supposed to be most suitable for those cases where the disease appears localised, but it is too extensive to admit, after its removal, of easy approximation of the duodenum to the stomach.

The operation of **Digital divulsion** of the pylorus, first practised by Loreta in 1882, and frequently adopted since for cicatricial stenoses of the orifice, is far from being a safe operation, and equally far from being a successful one. If not fatal, the relief is not infrequently only temporary. Barton<sup>5</sup> read a paper at the American Surgical Association in which he reviewed the results of twenty-five cases. Fifteen recovered and 10 died, giving a mortality of 40 per cent. Kennicutt and Bull,<sup>6</sup> in a collection of 18 cases, give 12 recoveries and 6 deaths, making a mortality of 33·3 per cent. Swain<sup>7</sup> records two fatal cases. In one the patient died with return of the vomiting on the fifth day. In the other, death resulted from collapse four hours after the operation. Allingham<sup>8</sup> also records a fatal case. In contrast, however, to such results must be placed two successful cases quoted by Treves.<sup>9</sup> The patients had been operated upon two years before, and in neither had any symptoms of recontraction appeared.

The operation of **Pyloroplasty**, performed for stenosis resulting from similar causes to those which call for digital divulsion, appears to be a safer operation and more certain in its results. It was first performed by Heineke in 1886, and from that year up to 1895 I have only been able to find fourteen other recorded cases. Of these 15, 3 died, giving a mortality of 21·42 per cent. Two cases are reported as having been seen at some period after the operation. Bardeleben's case, operated upon in 1888, was in good health in 1890. Page and Limont's case was perfectly well seventeen months after the operation.

<sup>1</sup> *New York Med. Journ.* 1891, vol. i. p. 39.

<sup>2</sup> *Lancet*, 1891, vol. ii. p. 921.

<sup>3</sup> *Lancet*, Murphy's tables, 1895, vol. i. p. 1015.

<sup>4</sup> *Lancet*, 1891, vol. ii. p. 1070.

<sup>5</sup> *Trans. Amer. Surg. Assoc.* 1889, vol. vii. p. 102.

<sup>6</sup> *Annual of the Universal Medical Sciences*, 1890, vol. iii. C—23.

<sup>7</sup> *Lancet*, 1892, vol. i. p. 87.

<sup>8</sup> *Brit. Med. Journ.* 1895, vol. i. p. 1095.

<sup>9</sup> *Ibid.* 1889, vol. i. p. 1105.

So far as these two operations of digital divulsion and pyloroplasty are concerned, they may very aptly be compared to treatment of stricture of the urethra by forcible dilatation or rupture, and by external urethrotomy. And just as experience has taught that complete division is more permanent in its results than forcible dilatation, so is it likely that pyloroplasty will be found to have a similar advantage over digital divulsion.

The operation of **Duodenostomy** was first performed by Langenbuch in 1879. It consists in opening the duodenum just beyond the pylorus. As it involves bringing the bowel up to the abdominal parietes, it can only be practised in those cases where the parts are freely movable. The operation has been too seldom performed to admit of any conclusion being drawn as to its value.

The operation of **Jejunostomy** may be considered when it is found that the disease has extended from the pylorus into the body of the stomach to such a degree that it is not possible to perform gastro-enterostomy. The operation has more frequently been performed when the disease has involved the cardiac orifice, and from there extended into the body of the organ. Two such cases were successfully operated upon by Jessett.<sup>1</sup>

The passage of a tube through the pylorus, after the performance of gastrostomy, appears to have been carried out with success by Hahn.<sup>2</sup> The patient was fed directly into the duodenum and lived for several weeks. The same operator, in the same paper, describes another method of dealing with the narrowed pylorus. It consists in digital dilatation of the pylorus without opening the stomach. The finger pushes before it the anterior wall of the viscus, and so 'gloved' is gently insinuated into the constricted orifice. This method of treatment is only advocated when gastro-enterostomy and other measures do not appear feasible. It was performed by Hahn prior to the introduction of gastro-enterostomy, and before also he knew of Loreta's operation. Hence it is more than likely, as he himself appears to indicate, that in the particular case in which he adopted it, he would have pre-

<sup>1</sup> *Trans. Clin. Soc. Lond.* 1892, vol. xxv. p. 105.

<sup>2</sup> *Berliner klin. Wochenschrift*, 1885, p. 846.

ferred Wölfler's operation had it at that time been a known procedure.

The operation of **Curetting**, which consists in opening the stomach and scraping away as much as possible of the growth which obstructs the pylorus, has so far apparently only been practised by the originator. Bernays, however, had such remarkably good results in the two cases upon which he operated in 1887, that the operation is worthy of some consideration. (See Chapter XXX.)

---

## CHAPTER XXVII

### DILATATION. CONDITIONS DEPENDENT UPON EXTERNAL INFLUENCES SUCH AS ADHESIONS, TUMOURS, AND SYSTEMIC DISEASES

**Dilatation.**—The condition of dilatation of the stomach has already been dealt with in connection with stenosis of the pylorus. It is introduced here, however, for separate consideration because of its requiring, under certain circumstances, separate treatment.

In 1892 Robert F. Weir,<sup>1</sup> of New York, and prior to him, although unknown to him at the time, Bircher of Switzerland in 1890, performed an operation for lessening the size of a dilated stomach.

In the case in which the operation was performed by Weir, the cause of the dilatation was pyloric obstruction. A gastro-enterostomy had been performed, but after a year the patient's symptoms of vomiting and gastric distress returned. That the patient's condition was not due to closure of the opening was proved by the audible escape into the bowel of gas pumped into the stomach. It was noticed before the first operation that the stomach was enormously dilated, being capable of receiving between eight and ten pints of fluid. It was therefore deemed possible that the symptoms from which the patient suffered were due to the dilated state of the stomach alone. Accordingly the abdomen was opened, and the stomach lessened in size by doubling in a fold of the wall and stitching the serous surfaces together so as to maintain

<sup>1</sup> *New York Med. Journ.* 1892, vol. lvi. p. 29.

the plaited condition thus produced. The patient recovered, and was relieved of his symptoms.

The three cases reported upon by Bircher are fully referred to by Weir, in the report of his own case.

In the first of these the patient, a man aged 46 years, had suffered for five years from pain in his back which was relieved by vomiting. The attacks lasted for several days. The stomach was recognised as being dilated, and systematic washing out and attention to diet considerably relieved the symptoms. But whenever the washing was stopped the vomiting recommenced. The operation of gastrorrhaphy was performed, and for three months the patient's condition continued good. A second operation was then performed, to remove a tumour from the lesser curvature which had been noticed at the first operation. The patient died shortly afterward. No note is given as to the state of the pylorus, so that the cause of the dilatation does not appear.

In the second case the operation was performed upon a woman aged 60 years, who for four years had had symptoms of dilatation. The cause was supposed to be muscular debility. The result of gastrorrhaphy was to restore the patient to perfect health. When seen three months later, she was perfectly well, and with normal digestive functions.

In the third case, Bircher operated upon a man aged 43, who had suffered from digestive troubles for twenty-one years. Vomiting had latterly become a very troublesome feature. There was well-marked splashing on succussion, and washing out the stomach removed a quantity of undigested food. Lavage always produced considerable improvement. After gastrorrhaphy, all the symptoms of dilatation rapidly disappeared and the patient remained permanently relieved.

From the experience gained by these cases taken in conjunction with his own, Weir concludes that the class of cases for which this operation seems likely to prove of most service is those 'which are constantly found running to a hospital, who are only improved temporarily by the use of lavage, and whose progress is associated with repeated relapses.'

An operation termed gastropexy has been performed by Duret for certain cases of displacement and dilatation. (See Operations on the Stomach, Chapter XXVIII.)

**Conditions dependent upon external influences such as adhesions, tumours, and systemic diseases.**—The stomach is liable to be affected by various conditions not immediately connected with its structure. These conditions may be purely mechanical, dependent upon some local pressure or displacement of the organ; or they may be more strictly functional, dependent upon some interference with the proper quantitative or qualitative supply of blood to the part or with its nerve supply. The result in either case is interference in some way with the normal digestive function.

Few of the systemic causes fall within the domain of the surgeon; it is only when the cause appears to be locally situated that surgical interference is called for.

Pressure exerted by tumours has already been alluded to in discussing the various causes of obstruction at the pylorus, it only remains to be said that the body of the stomach may similarly be impinged upon by tumours of a solid or cystic character arising from neighbouring organs or tissues. In many cases it will be impossible to determine, without an exploratory laparotomy, whether the tumour is intrinsic or extrinsic. Where the disease has its origin within the parietes of the stomach, the gastric symptoms are likely to be more marked than in the opposite condition. Little importance, however, can be given to this as a means of distinction, when it is remembered how gravely the body of the stomach may be involved in carcinoma and yet the gastric symptoms be almost nil.

In some cases, such for instance as aneurysm of the abdominal aorta, symptoms other than those connected with the stomach will assist in determining the true nature of the tumour.

There is a class of cases which has received some little attention within recent years where, as the result of inflammation, adhesions have formed between the stomach and neighbouring parts, giving rise to protracted and irremedial gastric symptoms.

At a meeting of the Clinical Society of London on October 13, 1893, Mayo Robson<sup>1</sup> related the histories of two such cases which he had successfully operated upon for dilatation

<sup>1</sup> *Trans. Clin. Soc. Lond.* 1894, vol. xxvii. p. 1.



of the stomach and severe pain due to adhesions. In the first case the adhesions were in the neighbourhood of the pylorus, and the result of a localised peritonitis caused by gall stones. In the second the adhesions were similarly situated, but owed their origin to a gastric ulcer. The operation consisted in both instances of detaching the adhesions. The dilatation of the stomach, which had resulted from the obstructive effect of the adhesions at the pylorus, disappeared.

A case of unusual severity has been recorded at some length by Treves.<sup>1</sup> In this case the operation revealed a collection of old tuberculous glands situated in the mesentery of the ileum. The great omentum was rolled up into a round and rigid cord, and was fixed to the mass of the glands in the iliac region. The effect of this adhesion and contraction had been to draw down the stomach to such an extent that it was impossible to raise it until the omental cord had been divided. It seems likely that the displacement of the liver and transverse colon downwards also depended upon the dragging effect of the contracted omentum. The case is given by the author as an illustration of Glénard's disease, a disease dependent upon undue relaxation of the abdominal parietes and the supporting ligaments of the abdominal viscera, whereby the latter become displaced downwards. The obvious lesions found, however, seem sufficient to explain the symptoms, and class it rather among those dependent upon displacements from adhesions, than upon undue laxity of parietes and suspensory ligaments.

In a paper dealing with adhesions and cicatricial bands in the abdominal cavity as a cause of continuous and severe colic, Lauenstein<sup>2</sup> figures and describes several cases where the stomach was dragged or pressed upon by such adventitious fibrous tissue. In some cases laparotomy was performed with permanent relief. Parker<sup>3</sup> quotes Rosenheim as having separated adhesions between the liver and the stomach in a case of persistent gastralgia; and Hahn as having separated adhesions between the colon and the stomach where the same symptoms were present.

<sup>1</sup> *Brit. Med. Journ.* 1896, vol. i. p. 1.

<sup>2</sup> *Archiv für klin. Chir.* 1893, Bd. xlv. p. 121.

<sup>3</sup> *Annals of Surgery*, 1896, vol. xxiii. p. 733.

## CHAPTER XXVIII

## OPERATIONS

- |                  |                       |
|------------------|-----------------------|
| 1. LAVAGE        | 7. GASTROPEXY         |
| 2. ASPIRATION    | 8. GASTRO-ENTEROSTOMY |
| 3. GASTROTOMY    | 9. PYLORECTOMY        |
| 4. GASTROSTOMY   | 10. PYLOROPLASTY      |
| 5. GASTRECTOMY   | 11. PYLORIC DIVULSION |
| 6. GASTRORRHAPHY | 12. PYLORIC CURETTING |

1. **Lavage.**—The process of washing out the stomach has already been fully described under the Treatment of Pyloric Obstruction (see page 215). It only remains here to refer to some of the dangers connected with the operation when employed for any disease of the stomach.

Fenwick,<sup>1</sup> in an exhaustive article on the dangers associated with lavage, gives syncope and sudden death as conditions occasionally happening. He attributes the results to sudden alteration in the gastric pressure, which brings about a reflex condition of shock. To avoid such accidents, care should be taken not to empty the stomach too rapidly or to introduce too large a quantity of fluid at one time.

In not a few instances symptoms of tetany have appeared within a short time after the removal of the tube. The cases have mostly been those in which the stomach was largely dilated. Kussmaul<sup>2</sup> gives three cases. Marten<sup>3</sup> records a case where faintness appeared soon after the tube was inserted, and two hours after its removal the patient began to complain of stiffness about the jaws and rigidity of the arms. Death ensued four and a half hours later. In a case recorded by Collier,<sup>4</sup> cramps set in the arms and legs five hours after lavage, and, as in Marten's patient, death took place from coma twelve hours after the operation.

That direct injury may be inflicted upon the walls of the stomach by the tube is shown in a case recorded by Roupell and McWhinnie<sup>5</sup> in their work on 'Poisons.' The injury

<sup>1</sup> *The Practitioner*, 1892, vol. xlviii. p. 241.

<sup>2</sup> *Deutsches Archiv für klin. Med.* 1869, vol. vi. p. 475.

<sup>3</sup> *Lancet*, 1887, vol. i. p. 74.

<sup>4</sup> *Ibid.* 1891, vol. i. p. 1251.

<sup>5</sup> Alderson, *Lancet*, 1879, vol. i. p. 6.

was inflicted by the suction action of the pump in a case of arsenical poisoning.

Perforation and rupture have also followed lavage. The former has happened when the operation has been performed in cases of ulceration. The latter happened in a case of my own where, three days after performing gastro-enterostomy, an attempt was made to wash out the stomach. The insertion of the tube evoked a fit of vomiting, which caused the patient to feel a sudden and acute pain in the pit of the stomach. The sequence of events was the rapid formation of a gastric fistula, and death from inanition.

Fenwick<sup>1</sup> records a case of hæmorrhage following emptying of the stomach in a patient suffering from pyloric stenosis and dilatation. As the bleeding did not recur on the second lavage, he attributed it to the too sudden relief of tension in the walls of the stomach, consequent on a rather hasty removal of its contents.

The power of the stomach to absorb somewhat rapidly fluids put into it, has led to more than one fatal case of poisoning. Almqvist<sup>2</sup> records an instance of profound collapse following upon lavage of the stomach with a solution of boracic acid. Hogner<sup>3</sup> mentions a similar case where death ensued in six days from the use of the same acid.

While thus enumerating some of the accidents which have resulted from such a simple process of treatment, it must not be concluded that the operation offers objections to its employment where it seems distinctly indicated. The frequency with which it is used by the physician without danger, and the unquestionable advantages attending its employment, are out of all proportion to the occasional occurrences of the above mishaps.

**2. Aspiration.**—The introduction of fluid or its withdrawal, or the removal of gas, by means of the aspirator is a mode of treatment but rarely resorted to. Occasions, however, do occur when it is not possible to successfully reach the stomach by way of the œsophagus. Dieulafoy<sup>4</sup> records the case of a

<sup>1</sup> *The Practitioner*, 1892, vol. xlviii. p. 251.

<sup>2</sup> *Schmidt's Jahrbücher*, 1883, vol. xcvi. p. 28.

<sup>3</sup> *Ibid.* 1884, vol. ccii. p. 237.

<sup>4</sup> *Treatise on the Pneumatic Aspiration of Morbid Fluids*. 1875, p. 133.

child poisoned through the administration of a dessertspoonful of laudanum six hours after birth. All other means failing, the medical attendant resorted to Dieulafoy's aspirator. By its means he succeeded in injecting into the stomach some strong coffee, which was then withdrawn. The process was repeated half a dozen times and the child was completely brought round. Foy<sup>1</sup> also mentions a case where he successfully employed the same measures. The patient was 'dead drunk.' The administration of an emetic seemed useless, from the fact of absorption being probably nil; and the introduction of the stomach tube appeared likely to interfere with the already very enfeebled respiration. Immediately the fluid commenced to flow into the aspirator, the heart began to beat and the pulse to be perceptible; respiration also recommenced.

Putting aside these somewhat exceptional instances of the use of the aspirator, there is a class of cases where much good has attended its employment. Cases of carcinoma of the stomach sometimes present enormous distension of the viscus with gas. In these instances the heart's action may be seriously embarrassed, and death becomes imminent if relief is not given.<sup>2</sup>

**3. Gastrotomy.**—The operation consists in an incision into the stomach for the removal of a foreign body, for exploratory purposes, and for the immediate treatment of certain constricted conditions of the cardiac and pyloric orifices. The gastric wound is closed at the same operation.

*Before operation.*—The patient's bowels should be cleared out as well as possible by copious enemata. The skin over the upper part of the abdomen should be cleansed and prepared in the usual way; and, as in all abdominal operations, the limbs of the patient, and as much of the trunk as is possible, should be clothed in some woollen material. Every other precaution also should be taken to maintain the temperature of the body.

**Operation.**—(1) *Skin incision.*—The choice of the incision is determined either by the existence of some definite feature in the case, as the tangible projection of a foreign body, or by considerations of anatomy. In the former instance the

<sup>1</sup> *Dublin Journal of the Medical Sciences*, 1887, vol. lxxxiii. p. 48.

<sup>2</sup> *Medical Times and Gazette*, 1873, vol. ii. p. 500.

incision is carried either obliquely or vertically over the spot where the body is most distinctly felt; in the latter, a vertical median incision may be made for some three inches or more downwards from the ensiform cartilage, or a curvilinear or oblique one from the median line outwards to the right for a similar extent, and about an inch below the costal cartilages. For exploration of the pylorus the median incision is the better; while for exploring the cardiac orifice the curvilinear is preferable.

All bleeding vessels in the abdominal wound must be secured prior to opening the peritoneal cavity.

(2) *Stomach incision*.—In the case of a foreign body, the object is sought for in that situation where the body projects most prominently; this being more particularly the case where the body is sharp pointed and possibly impacted. For purely exploratory purposes an endeavour is made to secure a point on the anterior surface about midway between the two orifices. It is, however, no easy matter to be certain of the particular area secured.

If it is practicable, the part of the stomach wall to be incised should be drawn up to and out of the parietal incision. In any case, sponges or cloths must be carefully packed around the part to be incised, with the object of preventing any escape of the gastric contents into the peritoneal cavity.

To prevent the possibility of the stomach slipping back into the peritoneal cavity before the operation is completed, it is advisable to secure it by a couple of stitches passed through its parietes on either side of the projected line of incision. These are left long so that they can be held by the assistant.

The incision in the stomach is made transversely to the long axis of the viscus, with the object of better avoiding the blood-vessels. A sharp-pointed curved bistoury may be used to complete the whole incision, or a puncture may be first made, and then the wound enlarged with scissors to the required extent.

All manipulations within the stomach must be carefully executed; more particularly does this apply to the extraction of long or sharp-pointed foreign bodies. In some instances it is advisable to alter the position of the body, so as to place it in a diameter which will admit of its easier passage through the wound.

To close the gastric wound the lax mucous membrane should be first stitched by a continuous suture, and then the serous coat doubled in by a series of Lembert stitches.

The wound is finally cleansed, the long 'securing' stitches withdrawn, and the sponges or cloths—the number of which is noted—removed. The stomach then slips back into its position, and the abdominal wound is closed in the usual way.

*After operation.*—The principle of the after treatment consists in rest to the patient generally, and to the stomach locally. The patient should be kept in a quiet room for three or four days, undisturbed by any other persons than those in direct attendance. Food should be administered *per rectum*, and only a little ice given by the mouth to relieve dryness of the tongue and fauces. On the third or fourth day, if all has gone well, fluid nourishment may be begun by the mouth and gradually increased.

4. **Gastrostomy.**—The operation consists in forming a fistulous connection between the stomach and the abdominal parietes, with the object of introducing food directly into the cavity of the former.

Various methods of operating have been proposed to effect this. The method usually adopted in this country, and also frequently practised abroad, is that originally suggested by Egebert, although modified in various matters of detail within recent years. In order to distinguish the operation from those introduced respectively by von Hacker, Hahn, Witzel, and Frank, I have attached Egebert's name to it, but the modifications introduced by Fenger and by Howse have materially assisted in placing it among the established operations of surgery.

*Egebert's operation.*—According to Greig Smith,<sup>1</sup> Egebert proposed the operation in 1837, but Sédillot first practised it in 1846. It was not, however, until 1874 that a successful result was recorded. In the interval between Egebert's proposal and Sydney Jones's success the operation had been practised several times both in this country and abroad, but always with a fatal result.

*Preparation of the patient before operation.*—The same preparations as advised for gastrotomy should be employed here. The patient, however, from the nature of the disease for which

<sup>1</sup> *Abdominal Surgery*, 4th edit. p. 353.

the operation is to be performed, being probably in a much more reduced state than in cases for gastrotomy, greater precautions should be taken regarding all points affecting the patient's strength. Expeditionness in operating is of considerable moment. A nutrient enema containing an ounce or two of brandy should be administered just prior to the operation.

**The operation.**—The surgeon first maps out as well as possible the outlines of the stomach and the liver. The excessively sunken condition of the abdomen—receding, as the parietes do, backwards from the ribs—renders the delineation of the anterior margin of the liver not very difficult. But the stomach, which probably occupies a position high up behind, beneath the diaphragm, is not so easily detected.

The surgeon will operate most conveniently by standing on the patient's right side.

**Skin incision.**—The opening into the peritoneal cavity has been made by various incisions. That, however, known as Fenger's is apparently the one most frequently employed (see fig. 19). It consists in carrying the incision for about two inches parallel to the costal cartilages on the left side and at a distance of one inch from the margins of the same. The point of commencement of the incision above is determined by the extent to which the liver descends. It should not cover more than half an inch of its margin, otherwise that viscus is liable to press injuriously upon the upper connecting stitches of the stomach and the parietes.

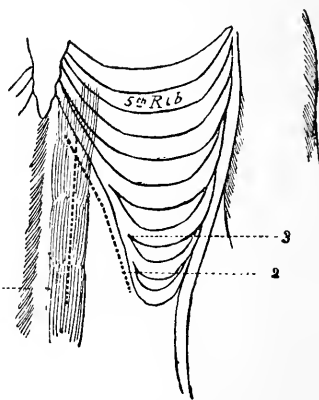

FIG. 19. — DIAGRAM SHOWING DIFFERENT LINES OF INCISION FOR GASTROSTOMY  
1, Von Hacker's; 2, Fenger's; 2 and 3, Hahn's

The other incisions practised have been mostly vertical, carried either through the linea semilunaris or through the fibres of the rectus muscle. The latter incision was suggested

and practised by Howse with the object of getting the muscle to act as a sphincter upon the opening and so prevent the escape of gastric juice.

As soon as all bleeding points are secured and the peritoneal cavity opened, the surgeon introduces his index finger, in an upward and backward direction, to search for the stomach. Some difficulty may be encountered in finding it, from its contracted condition and situation behind and high up beneath the diaphragm. The colon is liable under such circumstances to present itself, and without proper care may be mistaken for the stomach and stitched to the wound. To avoid any such fault the finger should be passed up the under surface of the left lobe of the liver to the portal fissure, then downwards along the gastro-hepatic omentum to the lesser curvature of the stomach, and so on to its anterior surface. As a further means of distinguishing the stomach from the colon, it may be pointed out that the former is much thicker in its walls, and of a more decidedly pinkish hue.

The stomach wall is hooked up by the finger, and then, between it and the thumb, brought out at the wound. If there appears to be much traction upon the organ, a portion of the anterior wall must be obtained where no such dragging exists, and in every case the endeavour should be made to get a part of the stomach nearer the cardiac than the pyloric orifice.

*Fixation of the stomach.*—As with the skin incision so with the fixation of the stomach to the abdominal wound, there are many ways in which it may be accomplished. Two ends, however, have to be prominently borne in mind whatever the means employed. First the stomach must be so secured that for the time being it cannot slip, and for the future some guide exists for the subsequent opening of the viscus; and, second, that a comparatively broad surface of stomach wall is made to adhere to the parietes around the wound.

The simplest way of effecting the first object is to pass a couple of 'sling' silk stitches through the two outer coats of the stomach, between which, when drawn taut, the subsequent opening will be easily made, and by means of which the further stitching of the organ to the parietes will be more readily effected. In order to obtain a broad surface of coaptation between the peritoneal surfaces of the stomach and the parietes.



one of three methods may be adopted. In that practised by Howse,<sup>1</sup> the stomach is pulled well to the side opposite to that to which the stitches are successively inserted. A needle threaded with silk is passed through the peritoneal and muscular coats of the stomach, and then made to transfix the abdominal parietes about an inch from the wound. The other end of the silk is then threaded and also made to transfix the abdominal wall close to the other. Some eight or ten stitches are passed in a similar manner completely round the wound. These, when drawn taut and tied, bring a complete circle of the stomach surface into close apposition with the parietes. If necessary a stitch or two should be inserted at each end of the incision to lessen its extent ; and, lastly, to ensure greater security a series of interrupted sutures may be passed around the edges of the skin incision, taking up at the same time the peritoneal coat of the stomach.

The method recommended by Greig Smith<sup>2</sup> should be adopted when it is deemed probable that the second stage

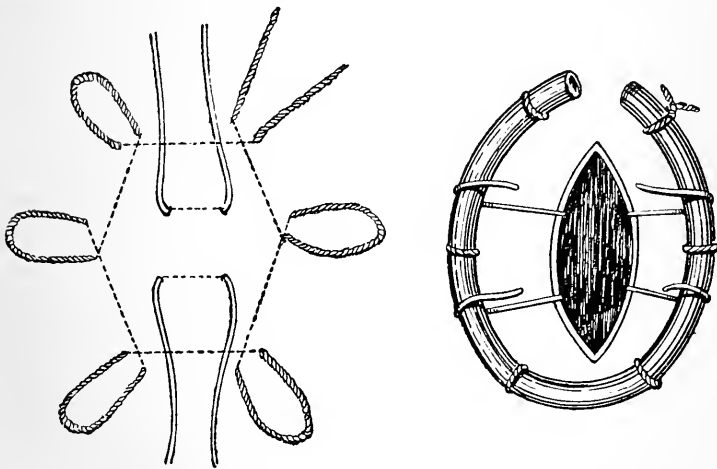

FIGS. 20 AND 21.—DIAGRAMS SHOWING FIXATION OF THE STOMACH TO THE PARIETES FOR IMMEDIATE OPENING IN GASTROSTOMY. (Greig Smith)

cannot be delayed and the stomach must be opened, if not at the first operation, at least a day or two after (see figs. 20 and 21). He thus describes his method :

<sup>1</sup> Heath's *Dictionary of Surgery*, p. 590.

<sup>2</sup> *Abdominal Surgery*, 4th edit. p. 372.

‘Firstly, following Bryant’s excellent suggestion, insert two loops of silver wire near the spot where the opening is to be made. By these the stomach is manipulated during the process of suturing, and they serve to fix it when the opening is made. Then, with a round needle threaded with thick soft silk about a foot long, pass a continuous suture in a circle of about two inches in diameter, under the peritoneal and muscular coats of the stomach. At every third quarter of an inch in the circle the needle is taken out and reinserted; so that six or eight free loops, about an inch and a half in length, are left protruding on the serous surface. Then, at corresponding situations in the abdominal wall, a handled needle with a hooked eye (Tait’s needle serves the purpose admirably) is pushed through and catches up the loops one after the other. As each loop is drawn through, a piece of rubber tubing is slipped under it. The loops are pulled with moderate tightness over the rubber tubing from each end of the incision. Finally the ends of the silver sutures are hooked under the tubing, and serve to keep the exposed portion of the stomach well up in the gaping wound. A suture at each end of the wound may be necessary.’

Jessett<sup>1</sup> has more recently advocated a procedure which he adopts for the operations of duodenostomy and jejunostomy, as well as for gastrostomy. In describing it for the former he states: ‘A loop is obtained sufficient to be easily drawn through the abdominal wound. I then pass a long straight needle armed with silkworm or chromic gut beneath the serous and muscular coats of the intestine in a longitudinal direction for from one to two inches, first on one side of the convex surface, then on the other; these two sutures run parallel to each other and are about an inch apart. I next pass two more needles armed with sutures across from the points where the longitudinal threads escape. I thus have a parallelogram enclosed between my four sutures; each of these is now passed through the abdominal parietes about half an inch on each side of its cut edge and then through a decalcified bone-plate with an opening in the centre’ (as shown in figs. 22 and 23). ‘The threads are next held in clamp forceps, while the

<sup>1</sup> *Surgical Diseases of the Stomach*, p. 61.

parietal wound is closed in the ordinary way. The threads are then tied firmly over the bone plates, first the lateral

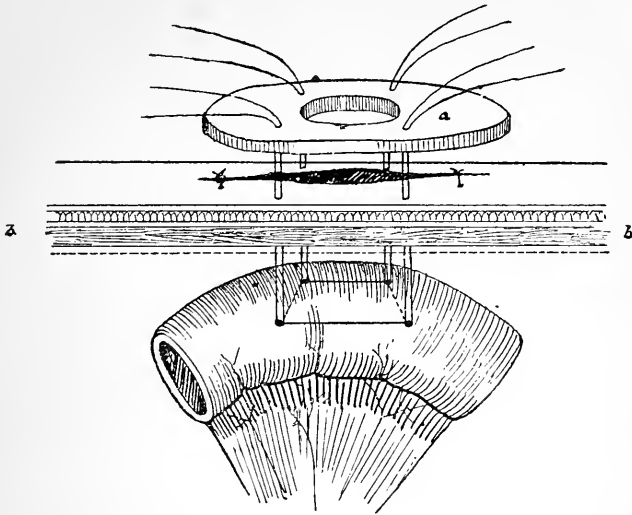

FIG. 22.—DIAGRAM SHOWING THE FIRST STEPS IN JEJUNOSTOMY. (Jessett)  
*a*, bone plate; *b b*, abdominal parietes.

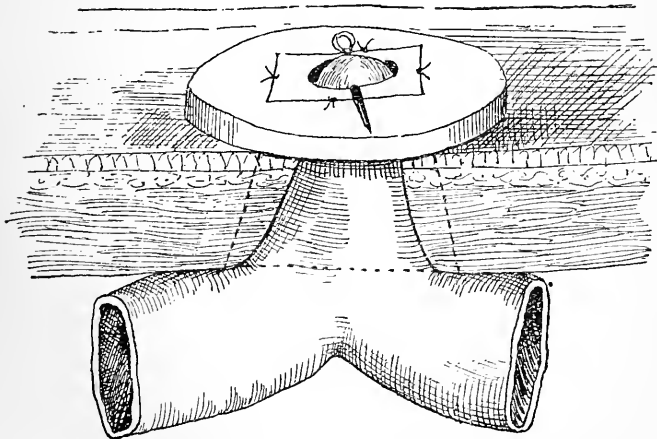

FIG. 23.—DIAGRAM SHOWING THE OPERATION COMPLETED BY PULLING UP AND TRANSFIXING THE WALL OF THE BOWEL OR STOMACH BY A PIN, AND TYING THE STITCHES OVER THE BONE PLATES. (Jessett)

threads and then the end threads; and finally a portion of the intestine is drawn up through the opening in the bone

plate and transfixed with a hare-lip pin which rests on the bone plate. The abdominal wound is closed by a couple of silkworm-gut sutures at each end.'

The wound is dressed antiseptically, and left from three to five days before the second stage of the operation is proceeded with.

*Opening the stomach.*—While this is usually executed on the third, fourth, or fifth day, it may prove necessary, from the low condition of the patient, to perform the operation earlier. The great advantage, however, of delay is to secure as firm and perfect adhesion of the stomach to the parietes as possible, and so prevent any contamination of the general peritoneal cavity by the escape of the gastric contents. This practical division of the operation into two stages, which has so materially advanced it along the lines of greater safety, is due mostly to Howse.

To form a communication with the stomach, the two temporary silk sling stitches are gently drawn upon, and a sharp-pointed tenotomy knife is plunged into the cavity of the stomach, sufficiently far to ensure of its having cleanly perforated the mucous membrane. By the aid of a probe or director, inserted after the withdrawal of the knife, an india-rubber tube or a piece of an ordinary gum-elastic catheter of No. 8 size is inserted. The external end of the tube or catheter is plugged and the wound cleansed, dusted with iodoform, and protected with a little absorbent antiseptic dressing. For this stage of the operation there is no need of an anæsthetic.

In cases where there is manifest evidence of the patient needing speedy nourishment, opportunity may at once be taken to introduce some milk and stimulant immediately after the tube has been inserted into the stomach.

*After treatment.*—For the few days which intervene between the two stages of the operation, the patient's strength should be maintained solely by nutrient enemata. The wound may not need to be touched; and where vomiting proves troublesome after the anæsthetic, care should be taken to give good support to the abdomen by well-applied binders.

When the stomach has been opened after the usual interval of time, attention is mostly devoted to the proper feeding of the patient.

A glass funnel or filler is attached to the indiarubber tube directly connected with the stomach, or to the piece of tube which has been affixed to the catheter, if the latter is used as the direct means of communication. In either case the distance between the parietes and the filler should be about eighteen inches. The food first administered should be entirely liquid, so as to pass readily through the tube or catheter. It should be warmed and from five to ten ounces in quantity. The amount given should depend upon what the patient has been accustomed to take prior to the operation. In cases of almost complete obstruction of the œsophagus small quantities only should be administered at first. As to the nature of the food, milk with egg and some stimulant will be the most suitable medium to commence with; later, soups; and, finally, ground-up meats may be added. The frequency with which food should be given will depend upon the quantity which the stomach can bear at a time. When only a little is taken, feeding will be necessary every hour or two. During the intervals of the meals the filler should be removed, the tube plugged and fixed by a bandage to the chest.

The tube should be changed every day, and finally removed when the fistula appears to be established. At this period the patient has usually learned to feed himself, and in some instances, after inserting the tube, he prefers to first masticate the food so as to enjoy the taste, and then eject it into the filler, by which, with the aid of some fluid, he is able to transmit it to the stomach. To enable the patient to introduce food of a more solid character, larger tubes have to be introduced. Although this may prove an advantage in one way, it renders the escape of gastric juice from the stomach more probable, and so is likely to give rise to troubles of skin irritation around the wound. In any case, when this complication arises, some artificial means must be adopted to try to prevent it. One method is to use the von Hacker-Scheimpflug canula, which consists of a double rubber balloon. Golding-Bird,<sup>1</sup> after opening the stomach by an incision sufficient to admit a No. 10 catheter, dilates the aperture with tents till a short piece of rubber tube, the thickness of the forefinger, can be introduced and tied *in situ*. The tube, which only just projects into the

<sup>1</sup> *Brit. Med. Journ.* 1896, vol. i. p. 16.

stomach and about one inch externally, is kept corked. The supposed advantage of this method is that the gastric musculature, from being gradually dilated, and not incised or ruptured by sudden stretching, contracts like a sphincter upon the tube, and so prevents any leakage. Harrison Cripps<sup>1</sup> introduces a small indiarubber disc about the size of a shilling, threaded with silk. It is drawn taut when within the stomach, and the ends of the silk tied over a roll of lint placed over the external orifice. In three cases in which it was tried it effectually prevented the escape of the gastric juice. Cotterell<sup>2</sup> effects much the same object by means of a small indiarubber valve attached about three inches from the end of a Jacques catheter. The valve closes like an umbrella when being introduced, but when within the stomach it expands again. A thicker piece of indiarubber is then slipped over the catheter and rests on the skin, being fastened to the catheter by a couple of small safety pins. But sometimes all mechanical contrivances fail, and it is chiefly for this reason that various other operations have been devised to try and surmount by natural measures this troublesome sequel to the operation.

**Results.**—Up to 1874, as already stated, the operation was uniformly fatal; since, however, the introduction of antiseptics and the more advanced knowledge obtained in connection with all abdominal operations, the operation has come to occupy a place among the perfectly feasible and safe practices of surgery. Performed, however, as it often is, on patients greatly reduced in strength, one of the most serious hindrances to success is due to this cause. Death from shock and exhaustion, therefore, must always rank as grave risks in considering the chances of operation. Failing, however, these, the only dangers within the first few days are death from inanition, and septic mischief. Should the patient survive well the second stage of the operation, life will be prolonged till death results from the natural progress of the disease, if, as most frequently happens, the operation has been performed for malignant disease of the œsophagus.

*Von Hacker's operation.*<sup>3</sup>—By this method the operator

<sup>1</sup> *Brit. Med. Journ.* 1896, vol. i. p. 1383.

<sup>2</sup> *Ibid.* p. 1557.

<sup>3</sup> *Wiener med. Wochenschrift*, 1886, vol. xxxvi. pp. 1073-1110

seeks to obtain some check to the escape of the stomach contents through the fistula.

A vertical incision about three inches in length is carried downwards from a point a finger's breadth below the costal cartilages on the left side and an inch from the median line. This incision exposes the belly of the rectus muscle, the fibres of which are separated but not cut (see fig. 18). Gérard, in order to obtain a more efficient sphincter action, crosses the fibres of the muscle. Slight modifications of this incision are practised by other surgeons. Both Howse and Jacobson<sup>1</sup> deal with the rectus in a somewhat similar way to von Hacker, only the skin incision made by each is different. The end, however, aimed at of securing the fibres of the rectus, for a sphincter to the fistula, is far from being uniformly attained. Von Hacker has himself been forced to use mechanical measures to prevent the escape of the gastric contents.

*Hahn's operation.*<sup>2</sup>—Prompted by the same motive, to operate in such a way that leakage from the stomach could not take place, Hahn performed in 1887 gastrostomy by a method quite different from that usually practised. The usual oblique incision about an inch below the costal arch is first made through the abdominal parietes, and the peritoneal cavity opened. A second incision, about two inches in length, is then made in the eighth intercostal space, close to the point of union of the eighth and ninth costal cartilages (see fig. 18). The peritoneal cavity is opened by a small incision, which is further enlarged to a sufficient extent by opening a pair of dressing forceps. By introducing the forefinger through the first incision, the stomach is sought for as previously described; and when secured between the forefinger and thumb of the left hand, the dressing forceps is passed through the intercostal incision and made to grip firmly a fold of the anterior wall of the organ. The forceps is then withdrawn, bringing with it the secured fold through the intercostal incision. The stomach is then stitched to the wound, and, if the condition of the patient will allow, not opened for the space of a few days.

In discussing the merits of the operation, which he has performed eight times, Hahn affirms that there is no danger

<sup>1</sup> *Operations of Surgery*, p. 764.

<sup>2</sup> *Centralblatt für Chirurgie*, 1890, No. 11, p. 193.

of opening the pleural cavity, nor of injuring the diaphragm, and claims that a small and contracted stomach can be more easily fixed in this position : that the attachment of the parts is more secure, and stitches are less likely to be attacked by the contents of the stomach : that it is easier to administer nourishment, and the escape of the gastric contents is prevented by the clamp-like action of the costal cartilages ; and, lastly, that no means for closing the orifice is necessary, nor is it possible, from the protective action of the cartilages, for the fistula to become unduly large. While Hahn appears to have had no untoward complications in his cases, Meyer<sup>1</sup> records that von Hacker and Hadra both saw necrosis of cartilage after it.

*Witzel's operation.*<sup>2</sup>—In 1891 Witzel published an account of this operation. Since that time it has been performed by several surgeons, and with almost uniform success in the cases recorded. As in the preceding operations, the chief object of the method is to prevent leakage from the gastric fistula. In this it appears to have been quite successful.

It is performed by opening the abdomen by the same oblique incision as used in Egebert's operation. The stomach is then sought for, in a similar way, and the anterior wall brought out of the wound to as great an extent as possible. A small opening is made into the cavity of the stomach, into which is inserted an indiarubber tube, some six inches in length and about the thickness of an ordinary lead pencil. Two parallel folds of the stomach wall are pinched up and united together, by a series of Lembert sutures, over the tube which is applied to the stomach wall (see figs. 24-26). This oblique passage should be about two inches in length. The free end of the tube passes out of the abdominal wound, while the stomach is stitched to the parietes, and the rest of the wound closed. Before putting a plug into the tube, or clamping it with a pair of forceps, an ounce or two of milk may be inserted through it into the stomach. When, however, the condition of the patient will admit of two or three days' delay, it appears better to keep the stomach quite at rest and feed by nutrient enemata.

<sup>1</sup> *Annals of Surgery*, 1893, vol. xvii, p. 596.

<sup>2</sup> *Centralblatt für Chirurgie*, 1891, p. 601.



The non-escape of anything through the fistula, Witzel explains by the assumption that a valvelike occlusion is most probably formed at the inner opening. In the post

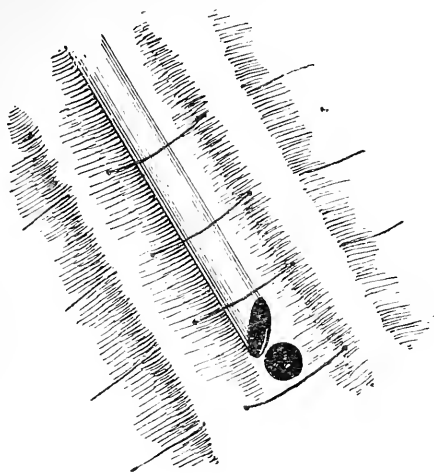

FIG. 24.

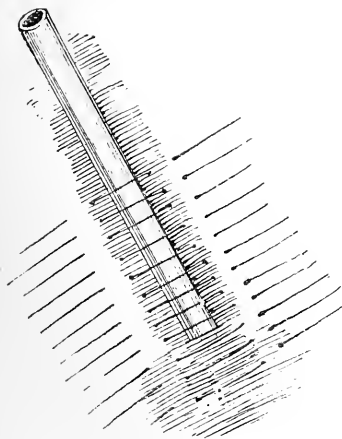

FIG. 25.

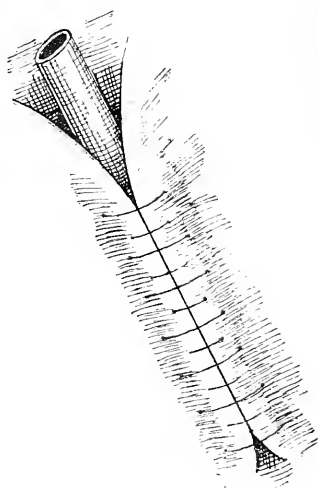

FIG. 26.

FIGS. 24, 25, AND 26.—DIAGRAMS OF WITZEL'S OPERATION, SHOWING METHOD OF STITCHING THE TUBE INTO THE STOMACH IN GASTROSTOMY. (Meyer)

mortem of a case recorded by Meyer<sup>1</sup>—the patient dying on the fifth day from bilateral pneumonia—a nipple-like pro-

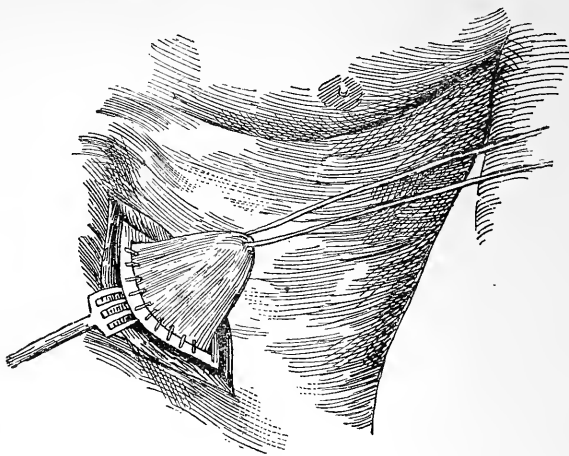

FIG. 27.

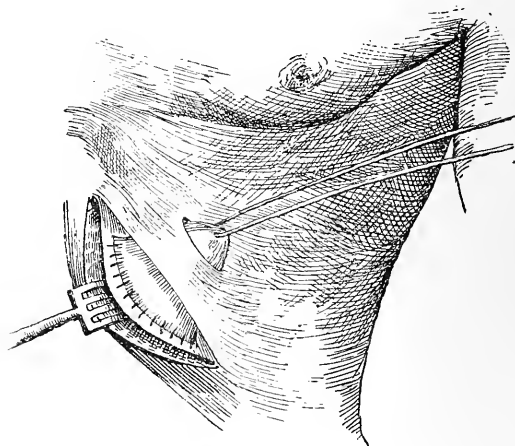

FIG. 28.

FIGS. 27 AND 28.—DIAGRAMS SHOWING FRANK'S METHOD OF SUBCUTANEOUSLY FIXING THE STOMACH IN GASTROSTOMY. (Meyer)

tubérance was observed at the point of entrance of the tube, which it was considered would effectually prevent any escape of the gastric contents.

<sup>1</sup> *Annals of Surgery*, 1893, vol. xvii. p. 511.

With regard to the tube, should it inadvertently slip out it can easily be reinserted. In one of Witzel's original cases he always removed the tube, reinserting it when a meal was to be administered.

In cases where the operation is performed for non-malignant stricture of the œsophagus, the fistula may be allowed to close so soon as the stricture is well dilated. In one of Mikulicz's cases the fistula closed sixteen days after the stricture had been successfully stretched and the tube removed from the stomach.

*Frank's operation.*—In some respects this operation resembles Hahn's. Instead, however, of the stomach being secured to an incision placed between the ribs, it is fixed beneath a bridge of skin to a second incision slightly above the first. It was performed by R. Frank in Albert's clinic in 1892.

The first steps of the operation are the same as those of Egebert's. A second incision is made parallel to and about an inch and a half above the first, over the costal cartilages. The skin is then dissected up, so as to form a narrow bridge. Beneath this a fold or cone of the stomach is pulled and fixed to the margins of the second incision (see fig. 27). An opening is made into the stomach, and the mucous membrane stitched to the skin. Ssabanejew, to whom also belongs the credit of having devised the operation some two years before its performance by Frank, performed it four times; in each case leakage was easily prevented. Frank reports four successful cases, and Meyer,<sup>1</sup> who refers to these eight cases, adds three of his own, one of which gave a good result; the other two, though fatal, were not considered fair tests of the operation.

**5. Gastrectomy.**—The operation of gastrectomy consists in the removal of a part of the body of the stomach. The more correct nomenclature for the operation would be partial gastrectomy; for, although the stomach has been entirely removed successfully in dogs, the operation in the human subject is understood to imply the removal of a portion of the body organ, the removal of the pylorus constituting the operation of pylorotomy. It must, however, be noted that Langenbuch has twice removed almost the entire human stomach

<sup>1</sup> *American Journal of the Medical Sciences* 1894 vol. cviii. No. 4, p. 400.

for carcinoma. In the case which recovered, seven-eighths of the viscus was excised. (See page 205.)

In preparing the patient for operation, the bowels should be emptied by copious enemata, and just prior to the operation a nutrient enema with some stimulant should be given. In cases where it is admissible, the stomach should be washed out for a few days previously, and also on the morning of the operation. The skin over the abdomen is cleansed in the usual way. The skin incision varies in position and extent according to the region of the stomach to be dealt with. As in most instances the first part of the operation is performed with the object of ascertaining the nature and extent of the disease, the incision is usually made in the median line. When, however, a distinct tumour is felt, the incision is carried in such a direction and to such an extent as will best enable that part of the stomach to be freely and easily dealt with.

In a successful case of gastrectomy reported by Porges,<sup>1</sup> the tumour was felt to be about the size of a fist; and in order to obtain the requisite space a transverse incision nearly eight inches in length was carried two inches below the xiphoid cartilage, from the middle of the right rectus muscle to the left costal cartilage. The resected piece was 7·2 inches long and 7 inches broad.

To remove any portion of the body of the stomach the part to be excised should be drawn well out of the wound, and the peritoneal cavity shut off by sponges or cloths packed in around. To prevent the stomach from slipping away, when once well withdrawn, two silk 'sling' sutures should be used, each suture being passed through both the serous and the muscle coats to an extent sufficient to give a secure hold, and just outside the line of the part to be removed. If a choice exists of the direction in which the incisions may be made in the stomach, they should be carried transversely to the long axis of the organ. By this means fewer vessels will be cut than if the incisions were carried in the opposite direction, parallel to the greater and lesser curvatures.

After removal has been effected and the bleeding points secured, the lax mucous membrane is sutured by a continuous

<sup>1</sup> *Annual of the Universal Medical Sciences*, 1892, vol. iii. C—5.

stitch, and the serous surfaces united by a series of Lemberts. The gastric wound being finally cleansed and the 'sling' stitches and the sponges or cloths removed, the stomach is allowed to drop into the abdomen. The parietal wound is then closed and the usual antiseptic dressings applied, with a firm binder securely fixed over all.

The after treatment of the case should be in every respect similar to that described in cases of gastrotomy. Both the patient and the stomach should be kept as quiet as possible, all feeding for the first few days being by the rectum.

**6. Gastrorrhaphy.**—The operation of gastrorrhaphy consists in diminishing the size of an enlarged stomach, by doubling in a portion of the wall, and stitching together the apposing folds. The operation was first performed by Bircher, of Aarau, Switzerland, who, unknown to Weir of New York, had operated on three cases prior to the latter. Weir, independently of any such knowledge, had successfully operated in a similar way.

Bircher operated in the following way: 'The stomach was previously washed out and carefully emptied. Parallel to the left edge of the ribs an incision six inches long was made, and the peritoneum opened. The stomach was drawn out. The edges of the wound being pulled apart and the lower edge being pulled upward, the greater curvature of the stomach was readily reached, and sewed to the lesser curvature by means of thirty-five silk stitches. This was aided by laying a long forceps on the stomach walls after fixing a suture at each end of the fold so that its weight pushed inward, for the time being, the stomach fold and allowed readier suture. The stitches were passed through the mucous and muscular layers. The wound was closed, and prompt healing took place.' For six days thereafter, nutrition was carried on only by enemata; and on the twelfth day the patient was up.

In the second of Bircher's cases the fold was made 'more vertically oblique;' while in both the other cases the fold was parallel to the long axis of the stomach.

Weir<sup>1</sup> dealt with the stomach in the following way: 'In the centre of the space between the upper and lower borders of the stomach, a dimpling in of the gastric wall was made

<sup>1</sup> *New York Med. Journ.* 1892, vol. ii. p. 29.

first, by pressure of a sound, to a distance say of an inch. A row of eight or ten interrupted silk sutures was now made passing through the serous and muscular coats for a distance of from six to eight inches, and the sound withdrawn. A second series of sutures at about an inch from the first was again made, dimpling in an additional portion of the stomach wall, and in a similar manner. A third and fourth row of interrupted silk sutures were applied, until through a distance of some four or five inches the greater curvature was applied to the lesser curvature. When the row was completed, a double fold of the stomach, estimated equal to the breadth of the hand and nearly its length, had been made in such a way that this projected into the cavity of the stomach.'

For the first six days the patient was fed entirely with nutrient enemata, but after that was allowed beef tea by the mouth.

Brandt<sup>1</sup> also records a successful case under the title of gastroplication.

7. **Gastropexy.**—Under this name Duret<sup>2</sup> describes an operation which he successfully performed for a case of displacement and dilatation of the stomach, called by Glénard gastropstosis. The operation consisted in opening the abdomen and fixing by sutures to the abdominal wall in their normal position the displaced pylorus and lesser curvature.

---

## CHAPTER XXIX

### OPERATIONS (*continued*)

8. **Gastro-enterostomy (gastro-jejunosomy, gastro-ileostomy, gastro-colostomy).**—By the operation of gastro-enterostomy is understood the formation of a permanent communication between the stomach and the bowel. The opening into the latter may be in any part of its course. It is most usual, however, that the connection is with the jejunum, hence the synonym gastro-jejunosomy. When the junction is with the

<sup>1</sup> *Centralblatt für Chirurgie*, 1894, No. 16, p. 361.

<sup>2</sup> *Revue de Chirurgie*, 1896, No. 6, p. 426.

ileum, it is strictly a gastro-ileostomy; and when with the colon, a gastro-colostomy. The operation described here will be the more commonly performed one of gastro-jejunosomy.

Proposed originally by Wölfler in 1881, it has been modified in various points of detail since; and it may still be said to be far from settled what is the best course to pursue throughout. The original plan of carefully stitching the stomach to the bowel has, with many American and English surgeons, given place to the more rapid means of uniting the surfaces by bone plates, metal buttons, or other like material. A disposition, however, exists on the part of many surgeons, especially in German schools, to practise the original method. Whichever method is adopted, the essential details require paramount attention. First, the operation must be performed as expeditiously as possible; and, second, the union of the bowel to the stomach must be absolutely secure. Failure in proper attention to one or both of these important details has been a not uncommon cause of an unsuccessful result.

The preparation of the patient for the operation, and the after treatment, have been fully discussed on page 215.

*Wölfler's operation.*—The skin incision is usually in the median line, between the ensiform cartilage and the umbilicus, and from three to four inches in length. After all bleeding points are secured and the peritoneal cavity opened, a search is made for the upper part of the duodenum. This is best effected, and with most certainty, by first turning the omentum up and to the left, and then taking the first loop of intestine felt in the left hypochondrium. Trace up that end of the loop which appears most likely to lead to the duodenum, and when thus verified select a portion which when applied to the stomach will not cause traction. Jessett<sup>1</sup> gives the following directions: 'Push the omentum over to the right and pass the index finger of the left hand down until it feels the top of the kidney, and then, following this to the vertebral column, a notch will be felt in the peritoneum which is the point at which the jejunum commences. Seize this, and follow it downwards until you have sufficient to apply easily to the stomach.' The loop of bowel chosen should then be clamped—that is, after squeezing the contents away in both directions

<sup>1</sup> *Medical Press and Circular*, 1891, vol. i. p. 608.

—the gut should be encircled at two places about three or four inches apart, either by a piece of indiarubber tubing, made to perforate the mesentery, tightened and secured by a pair

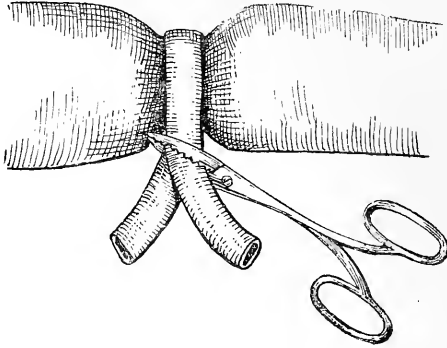

FIG. 29.—METHOD OF CLAMPING INTESTINE WITH RUBBER TUBE AND FORCI-PRESSURE FORCEPS. (Barker)

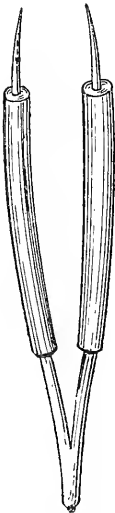

FIG. 30.



FIG. 32.



FIG. 31.

FIGS. 30, 31, AND 32 SHOW ONE PAIR OF DISSECTING FORCEPS WITH BLADES OPEN AND RUBBER TUBES ON BLADES READY FOR USE; AND A SECOND PAIR WITH BLADES CLOSED BY PASSING A SMALL PIECE OF TUBE OVER THE POINTS OF THE BLADES. (Maylard)

of catch forceps as practised by Barker (see fig. 29), or by two pairs of dissecting forceps. This latter method I have



adopted on several occasions and found it easily and rapidly done. On to each blade of the forceps a piece of rubber tubing is previously slipped. One blade is forced through

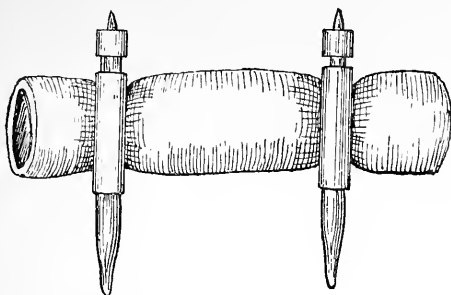

FIG. 33 SHOWS TWO PAIRS OF DISSECTING FORCEPS CLAMPING THE BOWEL.  
(Maylard)

the mesentery close to the bowel, and the two blade-ends are then clamped by a piece of tubing slipped over both (see figs. 30-33). A third and very simple method I saw adopted in Billroth's clinic. A few strands of worsted which had been properly sterilised were twisted together so as to make a soft cord. Two pieces of these were passed through the mesentery and tied moderately tight around the bowel. In whichever way secured, the loop of bowel is laid upon the abdomen and carefully protected with warm cloths. The stomach is next sought for, and the part of the anterior wall selected should be nearer the pylorus than the great cul-de-sac. The organ is drawn as far as possible outside the wound. Sponges or cloths, secured with a long thread of silk so that they can be easily withdrawn, are packed around the protruding viscera inside the peritoneal cavity. The loop of bowel is next uncovered and applied to the stomach in such a way that when the communication is established the contents of the stomach will be driven into the bowel in the direction of the normal peristalsis of the latter. This important detail was suggested by Rockwitz, and is sometimes expressed as giving a half-turn to the loop. Prior to the opening of either viscus a row of stitches may be placed below where the incision is to be made. This serves to better secure the parts in position when the openings are cut. This preliminary union of the parts should be about an inch and a half from

the greater curvature. An incision about an inch and a half in length is made in the long axis of the bowel, and an incision of the same length and direction in the stomach. Each of these incisions is made only through the serous and muscular coat, the mucous for the time being remaining intact. Union is effected for part of the circumference by stitching together the apposing serous and muscular coats. The mucous coat is then punctured in each viscus, and the openings enlarged to a sufficient extent. As at this stage the cavities of the two viscera are opened, great care must be taken that escape of either the gastric or intestinal juice does not contaminate the serous surfaces around. The apposing free margins of the mucous membranes are united by a continuous suture or by a series of interrupted sutures of silk or gut, and when thus a complete mucous channel is established, the remaining part of the circumference of the ununited serous surfaces is completed. The method of suturing adopted is that known as the Czerny-Lembert. (For the application of the various sutures used in gastro-intestinal surgery, see the chapter upon the Operations upon the Intestines.) The part, after being cleansed, should be finally examined by rotating it round, which can usually be easily done. At any point where there appears inefficient apposition of surfaces a Lembert suture should be inserted. To avoid kinking or bending of the bowel, as happened in cases operated upon by Billroth and Kocher, the method adopted successfully by Barker<sup>1</sup> should be employed, that is, a few additional Lembert stitches should be passed between the gut and the stomach for an inch or so beyond those employed for the union of the two orifices.

Any sponges or cloths inserted for protection into the abdominal cavity are removed, and the sutured parts allowed to drop back into position. The abdominal wound is closed and dressed in the usual way, and a firm binder applied around the abdomen.

The needles used for uniting the bowel and the stomach should be the ordinary sewing needles—that is to say, needles without cutting edges—curved to nearly a half-circle.

*Senn's operation.*—The most important modification of the operation which has been introduced within recent years is

<sup>1</sup> *Brit. Med. Journ.* 1886, vol. i. . 292.

that by Senn. It consists in approximating the parts by means of decalcified bone plates, and thereby materially shortening the period over which the operation extends.

In 1889 Senn<sup>1</sup> published the results of his experiments upon dogs, which proved the safety of the operation so far as these animals were concerned, and suggested its feasibility for adoption in the case of the human subject.

Probably the first case of gastro-enterostomy performed in this country with bone plates was by T. Kilner Clarke.<sup>2</sup>

The plates to be used are thus prepared by Senn: 'The compact layer of an ox's femur or tibia is cut with a fine saw into oval plates, one-fourth of an inch in thickness, two and a half to three inches in length, and an inch in width. The plates are then decalcified in a ten-per-cent. solution of hydrochloric acid changed every twenty-four hours, until they have become sufficiently soft to be bent in any direction without fracturing. After decalcification they are washed by letting water flow over them from three to six hours so as to remove the acid. The plates are then covered with porous paper and compressed between two pieces of tin until they are perfectly dry. If during the process of drying the plates are not compressed between two smooth surfaces they become distorted by warping. The hardened plates are next drilled several times in a straight line in the centre, and the openings enlarged and connected with a file until the perforation is five-eighths of an inch in length and about one-eighth to one-sixth of an inch in width. The sharp margins of the plate and perforations are removed with a file. With a fine drill the four perforations for the sutures are made near the margin of the oblong perforation, one at each end and one at each side. For preservation the plates are kept in absolute alcohol. When they are to be used they are washed in a two-per-cent. carbolic acid solution, and the threads or sutures attached by threading two fine sewing needles each with a piece of aseptic silk twenty-four inches in length, which are tied together. The threads are then fastened to the surface of the plate by another thread passing through the perforations in the shape of a loop and fastened at the back' (see fig. 34). (For the method of threading the plates see Chapter

<sup>1</sup> *Intestinal Surgery*, p. 179.

<sup>2</sup> *Brit. Med. Journ.* 1889, vol. ii. p. 1089.

LXV, on Operations upon the Intestines.) The first stages of the operation are similar to those described in Wölfler's method.

As soon as the selected parts of the bowel and the stomach are sufficiently withdrawn, an incision is made about an inch and a half in length in the long axis of the bowel. The two lateral threads of the bone plate are, by means of needles, made to pass through the wall of the bowel about a quarter of an inch from the opening and midway between the two ends. The stitches are passed from within out, and

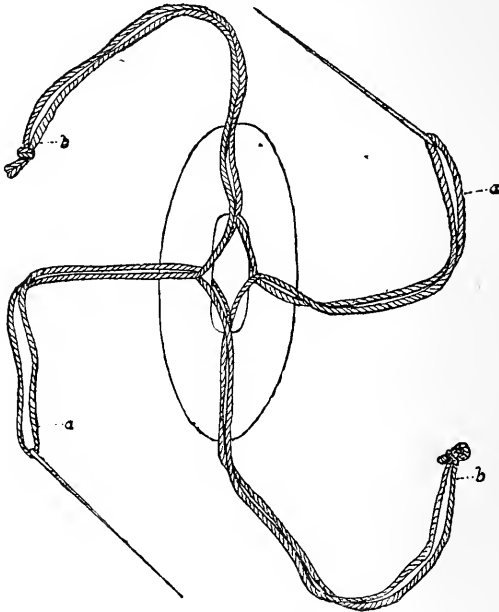

FIG. 34.—PERFORATED DECALCIFIED BONE PLATE, THREADED AND READY FOR USE. (Senn)

as they are drawn taut, the plate is slipped in through the opening and drawn into position. The remaining two stitches are brought out through the wound at each end. The ends of these threads are secured and taken charge of by the assistant, while the surgeon proceeds to follow out a similar procedure upon the stomach.

The plates are now brought together so that the two openings appose each other. The lower lateral threads are tied first, the end ones next, and the upper lateral last. To

obtain greater security, the serous surfaces may be scarified before bringing them together; and after the plate threads have been tied, a few Lembert stitches may be passed between the serous surfaces of the two viscera at the margins of the plates. The operation is completed as in Wölfler's method. That neither of the above methods of operating is all that can be desired is sufficiently attested by the numerous modifications which have been introduced.

To avoid the objection to Wölfler's operation of carrying the loop of bowel over the transverse colon and thereby possibly causing constriction of the latter, as well as risking the production of a kink<sup>1</sup> or sharp bend in the former, Courvoisier,<sup>2</sup> and later von Hacker,<sup>3</sup> attached the jejunum to the under surface of the stomach. An opening was made in the transverse meso-colon; the loop of jejunum was brought through and sutured to the posterior wall of the stomach. To avoid any constricting effect of the mesenteric opening, von Hacker stitched the margins of the latter to the stomach.

The want of a 'plate' which would be always easily obtainable has led to the employment of materials requiring less time for preparation than the original bone plates of Senn. Dawbarn<sup>4</sup> suggests plates made of raw potatoes; and in his experiments he tried various other vegetables, as carrots, parsnips, turnips, &c. When soaked for an hour or so in warm or tepid water, they become as rigid almost as wood. 'After remaining for a few hours exposed to the digestive fluids of either stomach or bowel, it [potato] begins to soften, while retaining its shape. At length it is completely digested and disappears, this occurring at a period of time varying according to what part of the alimentary canal it occupies. But always during the first ten or twelve hours at least—the time in which most of all we fear leakage at our anastomosis—it holds the peritoneal surfaces smoothly in contact.'

Baracz<sup>5</sup> has also successfully used plates made from raw cabbage turnip (*Brassica Napus* var. *rapifera*). The dimensions

<sup>1</sup> In a case of Billroth's, death resulted in ten days from this cause; and in a case of Kocher's in four days.

<sup>2</sup> *Centralblatt für Chirurgie*, 1883, p. 794.

<sup>3</sup> *Archiv für klin. Chir.* 1885, vol. xxxii. p. 616.

<sup>4</sup> *Annals of Surgery*, 1893, vol. xvii. p. 147.

<sup>5</sup> *Centralblatt für Chirurgie*, 1892, p. 575.

for these plates are—thickness 0.5 cm., length 7.5 cm., width 3.5 cm., central opening 3 cm. long and  $\frac{3}{4}$  cm. wide. With similar plates Heigl had a case of recovery after gastro-enterostomy.

The possibility of the plates slipping, so that their orifices are not exactly opposite each other, has led Littlewood<sup>1</sup> to fix a decalcified bone cylinder to one of the plates, which exactly fits the oval central opening. The cylinder, when the plates are in position, is made to pass into the oval opening in the other plate. A similar plan is proposed by Jessett.<sup>2</sup>

Among other kinds and shapes of materials used to unite the bowel to the stomach may be mentioned Murphy's Metal Button,<sup>3</sup> which although of too recent introduction and too little in use to admit of any opinion being expressed, yet appears to have the merit of shortening the period of operation beyond anything yet attained. The button consists of two parts (see figs. 35 and 36) which are separately

attached to the stomach and the bowel, union being effected by one fitting within the other, and so pressing the serous surfaces together. In a table published by Mayo<sup>4</sup> in January 1895, eight cases are recorded, with six successful results. (See 'Operations upon the Intestines' for method of using the button.)

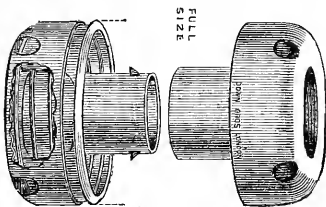

FIG. 35.

FIG. 36.

FIGS. 35 AND 36.—MURPHY'S  
BUTTON

Fig. 35 shows male half of button, which has a spring flange for keeping up pressure as atrophy proceeds. The two springs projecting through the fenestra in the hollow stem act as the male thread of a screw when the slank is telescoped within the stem of fig. 36; fig. 36 shows the female half of the button.

preparation formed into a thick circular cable; these are inserted respectively into the stomach and bowel, and approximated in a similar way to Senn's plates.

Brokaw uses segmented rubber rings. Four pieces of

<sup>1</sup> *Lancet*, 1892, vol. i. p. 865.

<sup>2</sup> *Surgical Diseases of the Stomach and Intestines*, p. 227.

<sup>3</sup> *New York Medical Record*, 1892, vol. xlii. p. 665.

<sup>4</sup> *Annals of Surgery*, 1895, vol. xix. p. 41.

ordinary rubber tubing are taken, about one-sixteenth to one-eighth of an inch in diameter. These are threaded through and through with catgut, so that a complete ring is produced. They are inserted and secured much in the same way as Abbe's rings.

Robinson<sup>1</sup> has experimented successfully with raw hide. The plates are 'made by shaving the hair from the green hide of an ox. Then cut the hide into strips an inch wide and two and a half inches long. Perforate the plate by a diamond-shaped aperture (half an inch by three-quarters of an inch). Then apply four to six sutures to the plate, armed with four to six needles, and it is ready for use.'

The contraction of the orifice between the two viscera, with reappearance of the original symptoms has led to other modifications in the formation of the two visceral wounds.

Paul<sup>2</sup> found that by strangulating the connecting surfaces of the stomach and intestine, an opening was left after the separation of the slough which apparently showed no tendency to contract.

Postnikow<sup>3</sup> adopts a somewhat similar method, with the exception that the part strangulated is limited to the mucous membrane which projects through a small oval, cut out of the visceral wall as far down as the muscularis mucosæ.

McGraw<sup>4</sup> recommends a wound whose edges should be lined by mucous membrane. By this means the continuity of the raw edge is broken. The incisions into the viscera may be crucial, H-shaped, or three-sided. The flaps so formed are turned back and secured to the serous surface.

**Results of operation.**—It is impossible, from the comparatively limited number of cases operated upon under any one of the various methods of gastro-enterostomy above described, to express any opinion upon their relative merits. A true criterion can only be obtained when a sufficient series of cases performed by one method and by the same surgeon has been published. Until such a series be forthcoming, surgeons must select from the numerous operations pro-

<sup>1</sup> *New York Med. Journ.* 1890, vol. lii. p. 429.

<sup>2</sup> *Liverpool Medico-Chirurgical Journ.* 1892, vol. xii. p. 355.

<sup>3</sup> *Centralblatt für Chirurgie*, 1892, No. 49, p. 1018.

<sup>4</sup> *Annals of Surgery*, 1893, vol. xviii. p. 313.

posed that particular one which appeals most to their own judgment. Reckoning under the same head all cases operated upon with absorbable plates, no matter what the material, Magill<sup>1</sup> has collected sixty-one cases with fourteen deaths, a mortality of 22·95 per cent., which he states constitutes a strong argument for this method of operating. Every method can claim a success, usually in the hands of the originator; but it is perhaps little known how many failures have fallen to the lot of others who have sought by that same method to achieve a like good result.

It is well to indicate some of the many sources of failure and troublesome after effects which are to be met with in the adoption of almost every method.

(1) *Regurgitation of the contents of the bowel into the stomach.* The effect of this upon the patient is extremely distressing. Eructations of foetid gas and fæcal matter cause the tongue to become dry and brown, and the mouth very foul. Great relief is obtained by freely washing out the stomach. This should be repeated as often as deemed necessary. Barker found benefit obtained by the administration of creasote, and from placing the patient in the semi-recumbent position, so that the opening into the bowel became dependent.

(2) *Pain.*—Acute pain is sometimes felt in the region of the stomach wound. At times slight, it becomes suddenly augmented by sharp stabs which cause the patient to cry out. More general pain over the abdomen indicates peritonitis. Opium by the bowel, or morphia subcutaneously, should be given.

(3) *Persistent vomiting and hiccough.*—This sometimes is very troublesome, and if it does not portend a rapidly fatal result from peritonitis or obstruction, may indicate at a later period a reclosure of the artificial opening.

(4) *Suppression of urine.*—In one of my cases this proved absolute. No urine was passed from the time of the operation till the patient's death, about four days later.

(5) *Collapse.*—In most of the earlier cases collapse was one of the commonest causes of death. The patient rallies but slightly, if at all, from the operation, and dies within a few hours.

<sup>1</sup> *Annals of Surgery*, 1894, vol. xxi. p. 313.



(6) *Exhaustion and inanition.*—Usually already in a more or less exhausted condition at the time of the operation, the patient's strength proves insufficient to survive the period necessary for the proper healing of the parts and the introduction of sufficient nourishment. Death occurs in a few days.

(7) *Hæmorrhage.*—In one case subsequent hæmorrhage caused a fatal result on the fourth day. In this instance no vessels had been secured by ligature at the time of the operation, pressure alone was used. The weakness of the patient at the time of the operation was probably the cause of the slight bleeding, and hence certain vessels escaped observation which would otherwise have been seen and properly secured.

(8) *Peritonitis.*—Either as the result of leakage, or inefficient 'toilette' at the time of operation, peritonitis has proved no uncommon cause of a fatal result. Acute and general, it may cause death in twenty-four hours; or if more localised and less acute, a more sluggish purulent form may cause death in a few days.

(9) *Gastric fistula.*—As the result of insecure stitching, coupled also sometimes with violent vomiting or retching, a leakage takes place at the line of union of the two viscera. If adhesions have sufficiently formed between the visceral wound and the parietes, the parietal wound gives way, and a complete communication exists between the stomach and the exterior. All nourishment given by the mouth passes out through the fistula, and the patient dies of inanition.

(10) *Intestinal obstruction.*—Obstruction in the bowel may arise from one of two causes. Either as the result of some obstruction in the bowel itself, from impaction of the plates used for coapting the visceral surfaces, or from a kinking or constriction of the part. In two at least recorded cases death has been caused by the bowel kinking just beyond its point of union with the stomach.<sup>1</sup> The bowel falling sharply away from its sutured surface forms a bend which efficiently stops any onward passage of the contents of the stomach. Any suspicion of such an accident should be treated by turning the patient on to the right side, or even into a semi-recumbent position. Constriction of the bowel may occur at the opening made

<sup>1</sup> See page 255, footnote.

in the meso-colon to pass the jejunum through before uniting it to the posterior wall of the stomach. Obstruction in the transverse colon may be produced by the loop of intestine which is carried over it to be stitched to the anterior wall of the stomach.

(11) *Subsequent closure of the bimucous fistula.*—The recurrence of symptoms some weeks or months afterwards may indicate the contraction or closure of the communication between the stomach and the bowel. In a case of Stansfield's,<sup>1</sup> in which Senn's plates were used, symptoms returned two months after the operation. On the death of the patient two months later, the orifice was found completely closed. In a case of Larkin's,<sup>2</sup> where Senn's plates were also used, the symptoms returned in eight weeks. When the patient died about five months after the operation, the opening was found completely closed. In a case by Keen,<sup>3</sup> in which Murphy's button was used, the opening was found, forty-seven days after the operation, to have diminished to one-half the original size.

(12) *Opening the ileum in place of the jejunum.*—In more than one instance this mistake has been made at the operation. Lauenstein records having united the ileum to the stomach at a point sixteen inches from the ileo-cæcal valve. The error is subsequently detected by the passage *per rectum* of food in a practically unchanged condition. Death occurs, as in gastric fistula, from inanition.

(13) *Pneumonia.*—Czerny records two deaths from pneumonia.

## CHAPTER XXX

OPERATIONS (*continued*): PYLORECTOMY; PYLOROPLASTY;  
PYLORIC DIVULSION, AND CURETTING (BERNAYS)

9. *Pylorectomy.*—The operation consists in total extirpation of the pylorus, together with the disease which implicates it. It therefore frequently embraces a considerable portion of the pyloric end of the stomach, as well as—in exceptional instances

<sup>1</sup> *Brit. Med. Journ.* 1890, vol. i. pp. 294, 1300.

<sup>2</sup> *Lancet*, 1891, vol. ii. p. 1222.

<sup>3</sup> McGraw, *Annals of Surgery*. 1893, vol. xviii. p. 313.

—a portion of the first part of the duodenum. The duodenum is then stitched to the stomach.

The preparation of the patient is in every respect similar to what has already been described in the preceding operations. (See page 215.)

The skin incision, from four to five inches in length, is made either in the median line above the umbilicus, or obliquely downwards from left to right, commencing an inch and a half or so to the left of the median line, and carried about the same distance above the umbilicus. In the only instance in which I performed this operation I used the oblique, and on the only occasion on which I assisted another surgeon, the median was employed. In both cases equally ready access was obtained to the parts required for operation. Other incisions have been employed, such as transverse and crucial. Both, however, should the patient recover, would tend to favour the subsequent development of a ventral hernia, owing to the weakening effect produced by a too free division of muscle fibres.

As soon as the abdomen is opened, the fore and middle fingers of the right hand are introduced to ascertain the condition of the tumour with regard to its size, freedom from adhesions, and extent of involvement of stomach, duodenum, and omenta, and also the existence or not of enlarged lymphatic glands. A few sponges or cloths secured with long pieces of silk are placed within the abdomen for protective purposes. The small omentum above is first severed from its connections with the upper border of the part to be removed. This is best effected by using an aneurysm needle threaded with gut or silk, and made to take up small portions of the omentum. A double ligature is passed, and the strand with its contained vessels divided between the two ligatures. When sufficiently freed, the forefinger of the right hand can be passed beneath the tumour and made to push its way at various points through the gastro-colic omentum close to its upper attachment, the membrane itself being severed in a similar way to the lesser omentum. I found this a very easy, rapid, and secure way of dealing with the lower omentum. The tumour thus freed from all attachments is brought out of the abdomen and a large flat sponge or cloth placed beneath it, to protect the

abdominal cavity from contamination from either the gastric contents or other external sources. At this stage enlarged lymphatic glands should be removed.

The next stage of the operation, or as it is sometimes termed the third stage, consists in the removal of the diseased parts.

By means of a pair of scissors the duodenum is first cut through just beyond the pylorus. To prevent any escape from either end of the divided bowel, each portion is taken charge of by a separate assistant. As soon as the division is effected and all bleeding points secured, the duodenum is either clamped, or tied round with a piece of rubber tubing. In some instances it is sufficient to stuff a piece of sponge or lint into the canal. In place of an assistant to take charge of the duodenum, it may be clamped or tied prior to division. The surgeon next turns his attention to the stomach. The cut in this viscus depends to some extent upon the manner in which, in cases of carcinoma, the growth has involved the organ. Where a choice exists, it is usual to cut with the scissors obliquely downwards from the lesser curvature to the right, keeping well free of the tumour. In cases where the growth extends more along the greater curvature, the direction of the incision is reversed, passing obliquely upwards from the greater curvature to the right. Where both curvatures are free than the intermediate part, the two oblique cuts are made with a vertical one joining both. To this central vertical part the duodenum is attached. In the other two instances it is usual to attach the duodenum to the greater curvature. When united to the lesser, a very ugly-shaped cul-de-sac is left; which is all the more marked if there is any dilatation of the stomach. The assistant, with the stomach grasped near the tumour, between the thumbs and fingers of both hands, everts the pyloric orifice, so that as the surgeon cuts through the stomach, nothing is permitted to escape from it. The division of the part need only be completed to within an inch or so of either curvature. Before complete severance of the tumour and after all vessels have been secured, the open part of the stomach may be closed by a series of interrupted Lembert stitches, or by a continuous suture. In the former case the stitches should all be left long, their free ends being

caught up together with a pair of forcipressure forceps. The advantage of this is, that by pulling on the stitches some manipulation of the part is made possible while effecting union with the duodenum.

After completing the section and securing any further bleeding points, the duodenum is applied to the orifice in the stomach. Stitching is commenced by uniting the posterior margin of the orifices first. This is effected from within, sutures being passed by a small curved needle with needle-holder and made to pick up and unite together the mucous membrane. As described by Jacobson<sup>1</sup>—‘They are passed first at the cut edge of the stomach between the mucous and muscular coats, carried on between the muscular and serous, then through the same layers of the duodenum, and finally brought out between these layers and the mucous membrane at the cut edge of the duodenum. When the posterior aspect of the two viscera is thus soundly closed, the anterior one is united by Lembert’s suture. If the cut mucous membranes do not come accurately together, a few sutures may be put in here separately from within. Care must be taken in inserting the sutures to avoid the formation of folds (Billroth).’ A weak point in the line of suture is at the angle of closure of the stomach. This should be particularly looked to before returning the parts.

At the completion of the union of the two viscera, a few stitches should be inserted to unite the edges of the severed omenta to the upper and lower borders of the newly formed parts.

The sponges or cloths are finally removed, the wound itself being carefully cleansed before dropping the parts back into the abdominal cavity.

Two very important modifications of the operation, serving to shorten the time of its performance, have been successfully carried out, making use of Senn’s plates and Murphy’s buttons<sup>2</sup> for the union of the two viscera, much in the same way as they are employed in gastro-enterostomy.

Rawdon<sup>3</sup> thus describes the operation as performed by him with Senn’s plates: ‘The stomach wound was closed with

<sup>1</sup> *Operations of Surgery*, p. 782.

<sup>2</sup> *Lancet*, 1895, vol. i. p. 1041

*Brit. Med. Journ.* 1890, vol. i. p. 323.

continuous sutures of fine silk, except one inch at the greater curvature, which was left open to admit of the introduction of one of Dr. Senn's plates of decalcified bone. A second plate, cut circular, was passed into the duodenum and placed so as to lie across it with the coats of the bowel overlapping the plate. The openings in the stomach and duodenum were now brought into apposition, and the corresponding ligatures on the two plates tied together, so that direct communication was established between the two viscera. The parts were returned into the abdomen, and the wound closed in the usual way. The operation was completed in less than an hour.'

The possibility of completing such an operation in so short a time as an hour must be considered a great advance upon what has hitherto occupied nearer three hours. The use of plates can, however, only be possible when the duodenum is sufficiently long and moveable to allow of their being coapted without tension. The necessary overlapping of the plate by the bowel naturally requires a greater length of the latter than in the case of simple suture, so that it is a method which cannot be applied in every instance of excision. For the same reason Murphy's button may not always be applicable.

The after treatment of the case is essentially the same as in other operations upon the stomach (see page 216). The great length of time which the operation has usually taken renders the factor of shock a very serious one; every care therefore must be taken to tide the patient over the first few hours after the operation.

*Results of operation.*—In by far the largest number of cases where death has followed the operation, it has been due to shock. In a considerable proportion perforative peritonitis has led to a fatal result. In Eiselsberg's<sup>1</sup> record of nineteen cases taken from Billroth's clinic between March 1885 and October 1889, there were ten fatal cases. Of these, seven were due to perforative peritonitis, one to hæmorrhage from the pancreas, and two apparently from shock. In this country most of the fatal results have been due to shock, death usually occurring within a comparatively few hours after the operation. The severance of the omentum from the greater curvature has been known to cause gangrene of the colon.

<sup>1</sup> *Archiv für klin. Chir.* 1890, p. 785.

**The combined operation of pylorotomy and gastro-enterostomy.**—This operation consists in the excision of the pylorus with the affected parts; complete occlusion of both bowel and stomach, and union of the jejunum with the latter.

The earlier stages of the operation are in all respects similar to those of pylorotomy up to the point where the tumour has been freed from its omental attachments and brought out of the abdomen. While the stomach is secured by the hand of the assistant, the surgeon proceeds to cut with scissors completely through the viscus beyond the affected part. The duodenum with the attached growth is turned aside outside the abdomen, and any escape from the internal parts prevented by the application of clamp forceps. The bleeding points in the edges of the divided stomach wall being secured, a continuous suture of fine silk or chromicised gut is made to occlude the gastric cavity by passing through the entire thickness of the stomach coats. A second line of sutures is then made, in order to bring the serous surfaces well and securely into contact. This may be effected either by a series of Lembert's or by quilt sutures. The stomach is then dropped back for the time being into the abdomen.

The tumour is next severed from its attachments to the duodenum. A clamp or rubber band is made to embrace the duodenum outside the point where the division of the gut takes place. The orifice of the bowel is then closed in the same way as that of the stomach, and when completed and cleansed dropped back into the peritoneal cavity, after removal of the clamp.

The stomach is again brought out of the wound, and the operation of gastro-enterostomy proceeded with as already described.

Tuholske<sup>1</sup> has performed the combined operation successfully in the reverse way. He first performed gastro-enterostomy, and later removed the diseased part.

**10. Pyloroplasty, or Heineke-Mikulicz operation.**—The operation consists in dividing the strictured pylorus much in the same way as an urethral stricture is treated by external urethrotomy, but in addition, the wound so formed is reunited in the opposite axis to that in which the original cut is made. The

<sup>1</sup> *Annual of the Universal Medical Sciences*, 1884, vol. iii. C—16.

patient is prepared in the usual way for operations upon the stomach. (See page 215.)

The skin incision adopted by Mikulicz<sup>1</sup> is four inches in length, running parallel with and about two inches from the left costal arch. Heineke opens the abdomen in the linea alba. After opening the abdominal cavity, the anterior wall of the usually dilated stomach is sought for and withdrawn out of the parietal wound. The parts beneath are protected with sponges or cloths.

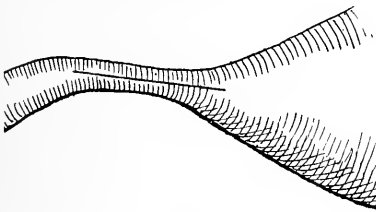

FIG 3 .

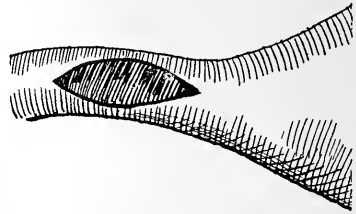

FIG. 38.

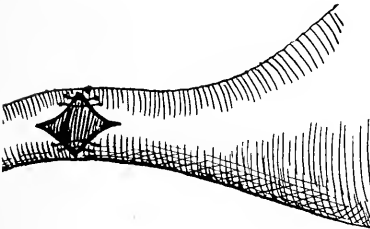

FIG. 39.

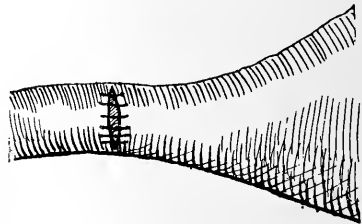

FIG. 40.

FIGS. 37-40.—HEINEKE-MIKULICZ OPERATION OF PYLOROPLASTY

Fig. 37 shows line of incision through constricted pylorus; fig. 38 shows the appearance of the parts after division of the stricture; fig. 39 shows method of suturing the wound; fig. 40 shows the suturing completed

A small longitudinal incision is made in the anterior wall of the stomach just at the boundary of the pylorus, of sufficient size to admit the finger. The contracted orifice is sought for by the index finger of the right hand, which serves as a guide for the passage of a director through the stricture into the duodenum.

By means of a blunt-pointed bistoury the pylorus is completely divided. Such bleeding points as need securing are

<sup>1</sup> *Archiv für klin. Chir.* 1888, Bd. xxxvii. p. 84.



ligatured. The longitudinal incision is then converted into a transverse wound by a double series of sutures, so applied as when tightened to bring the most distant points together, and make the middle of the two edges the most distant points of the new wound (see figs. 37-40). The parts are then returned, and the parietal wound closed and dressed in the usual way.

**11. Digital divulsion of the pylorus, or Loreta's operation.**—This operation consists in first performing gastrotomy, and then forcibly dilating the orifice of the pylorus with the fingers.

The preparation of the patient is the same as already described for other operations upon the stomach (see page 230); and the first stage of the operation, which consists in bringing the duodenum outside the abdominal wound, is performed in a similar way to that in pylorotomy, with the exception that the omenta are not severed from the upper and lower margins.

The operation as performed is thus described by Holmes.<sup>1</sup> 'After opening the abdomen on the right of the middle line and separating any adhesions of the pylorus to the neighbouring parts, the stomach is drawn out of the wound as far as necessary. The coats of the stomach are then lifted up in a transverse fold, and a cut made through them with strong scissors midway between the two curvatures and a little more than an inch from the pylorus. This, however, may need to be enlarged. Any bleeding in the incision must be stopped by ligatures. The right forefinger is then introduced and the pylorus examined. To commence dilatation by forcing in the finger, the left finger must also be introduced in order to steady the pylorus. Once the right finger is through, the pylorus is hooked down towards the abdominal wound, a manœuvre which may enable the operator to get the left index finger also through the pylorus. Considerable and prolonged force may be required to effect sufficient dilatation, owing to the powerful reflex contraction of the sphincter muscle. In Loreta's case it is reported that the observers noted that one finger was separated more than three inches from the other. The gastric wound is then closed and returned into the

<sup>1</sup> *Brit. Med. Journ.* 1885, vol. i. p. 372.

abdominal cavity. The parietal wound is stitched and the usual antiseptic dressings applied. If considered advisable, nourishment may be given by the mouth a few hours after the operation.'

In a case successfully operated upon by Treves,<sup>1</sup> an incision four inches in length was made in the linea alba, above the umbilicus. The attachments were so considerable that the parts could not be withdrawn. The stomach was opened by a vertical incision midway between the two curvatures and about two inches from the pyloric orifice. The object of the vertical cut and the greater distance from the pylorus was to avoid dividing large vessels. The gastric incision was closed by continuous silk suture through mucous and muscular coats, and Lembert sutures through the serous coat.

*Results of operation.*—Simple as the operation appears, it is far from being devoid of very grave consequences. With less stretching than that successfully exercised by Loreta, the wall of the stomach has been ruptured, death resulting in four hours. The orifice may recontract or become obstructed, and the symptoms return as early as the fifth day. Both such results occurred in cases reported by Swain.<sup>2</sup> Considerable hæmorrhage may result, the bleeding taking place freely into the stomach. (For further remarks upon the operation, see page 222.)

12. **Curetting the pylorus, or Bernays's operation.**—The operation consists in first performing gastrostomy and curetting or scraping away that portion of the growth which obstructs the pyloric orifice.

The operation as successfully performed by Bernays<sup>3</sup> was thus carried out: After the usual preparations, gastrostomy was performed. The stomach was first washed out with warm water. Then the finger was introduced, and a considerable quantity of the tumour removed by it. 'By means of the largest sizes of Simon's sharp spoons I scooped out all the soft masses until a grating noise was produced by the instruments against the indurated base of the tumour. . . . A current of cold carbolised

<sup>1</sup> *Brit. Med. Journ.* 1889, vol. i. p. 1105.

<sup>2</sup> *Lancet*, 1892, vol. i. p. 87.

<sup>3</sup> *Annals of Surgery*, 1887, vol. vi. p. 449.

water was next turned into the stomach and was allowed to run until the fluid returned clear.' The operation lasted an hour and a half. The masses removed weighed fourteen ounces. About nine hours after the operation the patient drank a glass of milk, which he retained, and although more was subsequently taken, nothing came out through the abdominal wound. Some leakage, however, took place on the fifth day, and henceforward unless the patient took some precautions with regard to his food. Two months after, the fistula was closed. A month later, however, it had to be re-opened in order to rescrape, which was also accomplished successfully. In the second case successfully operated upon by Bernays, much the same method of procedure was adopted ; but the tumour was much smaller, and the amount removed only weighed fourteen drachms.

In his remarks upon these two cases, the author advises strongly against the performance of gastrotomy and the return of the stomach. Obstruction is certain to recur, and a permanent orifice is necessary in order to repeat the curetting.

For the prognosis in respect to the operations described in this chapter when adopted for obstructions at the pylorus, see Chapter XXVI, p. 218.



## PART III

### *THE SMALL AND LARGE INTESTINE*

---

## SECTION I

### THE DUODENUM

## CHAPTER XXXI

### ANATOMY. INJURIES: RUPTURE; FOREIGN BODIES

**Anatomy.**—The duodenum, so called from its length, being about equal to the breadth of twelve fingers—that is, from ten to twelve inches—forms the upper of the three portions into which the small intestine is arbitrarily divided. It is the widest part of the small bowel, varying in diameter from an inch and a half to two inches, and takes a course which may roughly be described as horseshoe in shape, with the convexity of the curve to the right.

Commencing at the pylorus, it is directed slightly upwards and backwards to the right to the neck of the gall bladder. It measures about two and a half inches in length, and constitutes the first or superior portion. Its relations are—in front and above, to the liver and gall bladder; behind, it has the gall duct and the hepatic vessels. It is entirely surrounded by peritoneum.

The second or descending portion extends from the neck of the gall bladder downwards to the body of the third lumbar vertebra. It is in contact in front with the transverse colon and meso-colon. Behind, it is connected by areolar tissue with the right kidney and the vertebral column. To the left is the head of the pancreas. Descending behind the left border of the gut is the common bile duct, which together with the

pancreatic duct perforate obliquely the walls of the bowel and open, by a common orifice into its interior, at a point about four inches from the pylorus. It is covered by peritoneum only on the anterior surface.

The third, transverse or oblique, portion extends to the left, ascending slightly from the right side of the body of the third lumbar vertebra to the left side of the second. Here it terminates by forming an abrupt angle with the commencement of the jejunum. In front and passing over the upper border are the superior mesenteric vessels. Behind are the aorta, inferior vena cava, and pillars of the diaphragm.

The mesentery commences where the duodenum becomes continuous with the jejunum. A notch, which can be felt in the peritoneum, serves as a guide to this particular part.

The part of the duodenum, about an inch long, which extends along the side of the left crus of the diaphragm opposite the second lumbar vertebra is sometimes termed the fourth, or second ascending, portion. It is firmly fixed to the front of the aorta and the crus of the diaphragm by a strong fibro-muscular band which has been termed the 'musculus suspensorius duodeni.' By means of this ligamentous band the duodenum is held up as by a sling, and kept constantly in position (Treves).

In relation to the surface of the body, the duodenum occupies the right hypochondriac, right lumbar, and umbilical regions. On the right side, a little below the ninth rib, the hepatic flexure of the colon lies in front. A point about an inch above the umbilicus marks the place at which the transverse portion crosses the spinal column. Behind, the spine of the second lumbar vertebra is just above the duodenum.

In its minute structure the duodenum resembles the other parts of the intestine. Of the four coats—serous, muscular, submucous, and mucous—the first, as already indicated, only surrounds the bowel to a limited extent. As regards the mucous membrane, *valvulae conniventes* begin to appear a short distance from the pylorus, and become very large in size just beyond the orifice of the bile and pancreatic ducts. Villi are present in abundance throughout. The crypts of Lieberkühn are also found in its whole extent; and Brünner's glands, which are universally present, are found most

abundantly a little way from the pylorus. The solitary glands exist throughout, but the agminated glands or Peyer's patches are only occasionally met with in the lower part. The cells which line the surface of the mucous membrane are of the columnar type.

The arteries supplying the part come from the pancreatico-duodenalis superior, a branch of the gastro-duodenalis, itself a branch of the hepatic; and from the pancreatico-duodenalis inferior, a branch of the superior mesenteric. These two arteries form a partial circle on its concave border, coursing between the duodenum and the pancreas. The further distribution of the vessels resembles that of other parts of the small intestine, and will, together with the lymphatic and nerve supply, be described when dealing with the minute anatomy of those parts.

**Injuries.**—The deep situation of the duodenum renders it comparatively secure against injury. Its fixed position, however, renders it less likely to escape than if, like other portions of the small bowel, it were freely movable.

While it may be injured by bullet or shot, or by stabs or sword thrusts, such wounds are always associated with similar injury to the overlying parts. The only injury which, it appears, may limit itself solely to the duodenum, is rupture produced by a direct blow or a squeeze upon the part.

**Rupture.**—It is perhaps doubtful whether rupture of the duodenum is of such frequent occurrence as alleged by Erichsen,<sup>1</sup> who appears to base his statement rather upon the supposition that it must be so from the anatomically fixed position of the part than from actual experience. Most authors speak of the accident as an extremely rare one. Poland<sup>2</sup> collected a series of forty cases of rupture of the small intestine, only four of which occurred in the duodenum. Of cases reported within the last few years, I have only been able to find five.

**Symptoms.**—There are no symptoms special to the injury; such as do appear are variable and indistinguishable from those which arise from rupture of the small bowel elsewhere.

The patient immediately on receipt of the injury complains

<sup>1</sup> *Science and Art of Surgery*, 9th edit. vol. i. p. 877.

<sup>2</sup> *Guy's Hospital Reports*, 3rd series, vol. iv. p. 142.

of pain more or less intense and continuous. Usually it is felt in the epigastric region, but sometimes in other parts. In a case reported by Yarr,<sup>1</sup> pain was limited to the suprapubic region; while in a case reported by Heelis<sup>2</sup> it was just above the right groin. The amount of shock which follows varies. When the injury is produced by a sharp blow, the resulting shock appears to be more marked than when it follows upon a severe squeeze. Physical examination of the abdomen may reveal but little. The skin is usually intact, and manipulation of the belly may or may not elicit tenderness. In a case reported by Freeman,<sup>3</sup> where the patient was kicked in the abdomen by a mule, and an opening was found at the post mortem in the anterior surface of the duodenum about an inch in diameter, no tender spot could be detected, nor was there any trace of external injury.

Vomiting usually takes place at some period after the injury, and as a rule the vomit does not contain blood. If death does not result from the primary shock, the patient generally rallies for a time, but sinks sooner or later in a condition of collapse. In a case reported by Collier,<sup>4</sup> the secondary collapse appeared thirteen hours after the injury, when the patient died. In another case, reported by Hutchinson,<sup>5</sup> the patient lived sixteen days.

The symptoms which develop later are those referable to general peritonitis.

As regards the seat and nature of the rupture, the most frequently injured part is the lower half, that is to say, the part which is most fixed; and the lesion, which is usually on the anterior surface, varies from what is a comparatively small perforation to a complete severance of the entire circumference. In Yarr's case the rupture was about the size of a sixpenny piece, while in Heelis's, two-thirds of the circumference was torn through at the junction of the second and third portions on the right side of the second lumbar vertebra; and in Collier's a complete separation had taken place where the bowel crosses the second lumbar vertebra.

<sup>1</sup> *Brit. Med. Journ.* 1890, vol. i. p. 1131.

<sup>2</sup> *Lancet*, 1892, vol. i. p. 191.

<sup>3</sup> *Brit. Med. Journ.* 1889, vol. i. p. 945.

<sup>4</sup> *Lond. Med. Gazette*, 1833, vol. xii. p. 766.

<sup>5</sup> *Archives of Surgery*, 1891, vol. iii. p. 97.



**Treatment.**—While all the ordinary measures are being adopted to secure rest and relief of pain and shock, the chief consideration centres upon the question of operative interference. Whatever arguments are used for or against an exploratory operation in cases of rupture in other parts of the bowel must apply here, for the very reason that it is usually impossible to diagnose rupture of the duodenum from rupture elsewhere. Hence, as no question can be raised as to the advantage of opening the abdomen in cases of rupture, for instance, of the jejunum, none can be entertained with regard to a like injury to the duodenum. If it should ever prove possible to diagnose with any degree of certainty such a lesion as here discussed, there might be some reason for considering the arguments which Hutchinson brings forward for conservative measures, in the paper which he wrote in connection with his own case. It is quite possible to conceive that with an organ so deeply situated, so fixed, and so well covered by the close apposition of other parts, healing might take place and a good result accrue, where operative interference would prove harmful. It is quite reasonable to suppose that such good results have happened; it is, however, quite impossible of course to know. The only question therefore which can be raised is regarding the proper time to operate. To attempt any grave measure when the patient is in a collapsed condition is likely to prove as useless as to operate when peritonitis has well set in. The proper time therefore is after the primary shock has passed away; this will usually be in the course of a few hours.

As in most, if not all, cases the diagnosis will be purely conjectural; conjecture, however, will give place almost to certainty if the surgeon, on opening the abdomen, finds by the presence of gas and possibly extravasated material the evidence of rupture, yet can detect no lesion in any part of the stomach, jejunum, ileum, or large intestine. A careful examination of the duodenum will then probably reveal the lesion.

For details concerning the treatment of the rupture, the reader must refer to the discussion of the subject in connection with similar lesions of the jejunum and ileum; suffice it to say here briefly, that an attempt should be made to close the severed parts by suture. Not the least important of all

treatment is the efficient washing out of the peritoneal cavity, and the subsequent drainage of the part. This part of the treatment itself might, in the case of a small lesion, prove sufficient. The sole after danger is peritonitis, and the sole prevention is early operation, thorough cleansing of the peritoneal cavity, and, if necessary, drainage.

CASE LVI.—*Rupture of the third part of the duodenum.*

A soldier aged 22 was admitted into hospital on the morning of October 9, having been kicked in the abdomen by a mule. He was knocked down by the blow, and being unable to move was at once brought to hospital in an ambulance waggon. He complained of severe persistent pain in the epigastrium, and lay in bed with his knees drawn up. He appeared to be suffering somewhat from shock, but his pulse was strong and regular, and respiration normal. On examination no specially tender spot could be detected; the abdomen presented no external marks of violence, and the area of hepatic dulness did not appear to be increased. He vomited slightly after the administration of some brandy, but again vomited copiously, bringing up the contents of the stomach without any admixture of blood. After this he appeared relieved, and seemed disposed to sleep. In the evening he seemed doing well, and passed a good night. Unfavourable symptoms, however, developed the following morning (the 10th) about 8.30 A.M., when he complained of intense pain in the abdomen and suddenly became collapsed. At 9.30 he was cyanosed and pulseless. Percussion of the abdomen revealed absolute dulness all down the right flank and extending inwards towards the middle line. Respiration was very laboured. There was no delirium. Death supervened at 10.45 A.M., nearly twenty-four hours after admission. No motion was passed while he was in hospital.

*Post mortem.*—There was no bruising of the abdominal parietes. General peritonitis was present. The only lesion found was an opening an inch in diameter on the anterior surface of the lower part of the duodenum, the margins of which were regular and deeply congested. (Freeman, 'Brit. Med. Journ.' 1889, vol. i. p. 944.)

**Foreign bodies.**—The lodgment of foreign bodies within the duodenum is of such rare occurrence that little more than a passing notice is necessary. The large calibre of this portion of the small intestine enables most foreign bodies which are able to pass the pylorus to find their way lower down before becoming impacted. A somewhat extraordinary case is reported by Marshall.<sup>1</sup> Complete obstruction took place in the duodenum owing to the impaction of a mass of pins weighing about a pound.

<sup>1</sup> *Trans. Med.-Chir. Soc. Lond.* 1895, vol. xxxv. p. 65.

## CHAPTER XXXII

## DISEASE. SIMPLE OR CHRONIC ULCER. ACUTE ULCERATION

'IN no part of the alimentary canal are the diseases to which it is liable so obscure in their origin and diagnosis as in the duodenum.' These words, written more than fifty years ago by Curling, still remain applicable at the present day. It is almost as difficult now as it appears to have been then to distinguish diseases of this part of the bowel from like affections occurring elsewhere in the immediate neighbourhood.

The diseases here selected for treatment are only such as are of interest to the surgeon.

**Simple or chronic ulcer.**—This form of ulcer resembles in every respect the simple ulcer of the stomach. Not only in its pathology, but in the symptoms to which it gives rise and in the course which it pursues, it shows a marked resemblance to that ulcer. Its one comparatively minor feature of difference lies in the fact that it is more frequently met with in males than in females. Out of sixty-four cases collected by Krauss,<sup>1</sup> only six were females. In ten cases collected by Kelynack<sup>2</sup> from the 'Pathological Reports' of the Manchester Royal Infirmary, all were males.

The commonest age for the appearance of the ulcer is between 30 and 40 years. In seven out of ten of Kelynack's cases the average age was about 33. There are, however, marked exceptions at both periods of life. Hebb<sup>3</sup> records the instance of a man aged 63 years, and a female child aged 3 months; and Woods<sup>4</sup> reports the case of a newly born child. Death took place thirty-five hours after birth from perforative peritonitis.

With but few exceptions the ulcer is found within one or two inches from the pylorus; and it more frequently occupies

<sup>1</sup> *Annual of the Universal Medical Sciences*, 1892, vol. i. D-6.

<sup>2</sup> *Brit. Med. Journ.* 1894, vol. ii. p. 915.

<sup>3</sup> *Westminster Hospital Reports*, 1891, vol. vii. p. 79.

<sup>4</sup> *Medical Press and Circular*, 1878, vol. i. p. 88.

the anterior than the posterior wall, but is sometimes found at the inferior border.

In most cases it is usual to find a single ulcer, but two or more are sometimes present, and now and again an ulcer is found in addition in the stomach. In two out of three cases reported by Mackenzie,<sup>1</sup> two ulcers were found; and in a specimen shown by Moore<sup>2</sup> to the Pathological Society of London, besides the ulcer in the duodenum, three minute ones were found in the stomach.

**Symptoms.**—Although extremely variable, the symptoms may sometimes be sufficiently distinctive to warrant a positive diagnosis being made. Between the two extremes of no symptoms and pronounced symptoms there are all shades of severity. As in gastric ulcer, but more frequently than in that condition, the patient may be in perfect health until suddenly struck down with symptoms which may prove fatal in a few hours.

In an exhaustive paper on the differential diagnosis between gastric ulcer and duodenal ulcer, Bucquoy<sup>3</sup> attaches most importance to the following symptoms as distinctive of the latter: (1) Copious and sudden hæmorrhage by the bowel; (2) the position of the pain, at a zone corresponding to the inferior border of the liver and between the border of the false ribs and the iliac crest; (3) to certain digestive troubles, of which the most important are acute attacks of colic, occurring three or four hours after the ingestion of food.

That duodenal ulcer may be present and yet the symptoms manifested none such as depicted here, is sufficiently attested by numerous published cases. As regards the seat of pain, Roper<sup>4</sup> records the case of a man aged 55 who complained of pain of not very severe character in the epigastrium and left hypochondrium. It was usually worse after a hard day's work. The patient described the pain as not constant, both as regards situation and period of appearance. Sometimes it was on one side, sometimes on the other, and frequently of a burning character. It generally started at the

<sup>1</sup> *Lancet*, 1888, vol. ii. p. 1061.

<sup>2</sup> *Trans. Path. Soc.* 1883, vol. xxxiv. p. 98.

<sup>3</sup> *Archives Générales de Médecine*, 1887, vol. i. pp. 398, 526, 691.

<sup>4</sup> *Lancet*, 1893, vol. i. p. 1193.

PLATE XI.



Fig. 41.—PERFORATING ULCER OF DUODENUM.—The ulcer is situated just beyond the pyloric orifice. The floor of the ulcer is formed by pancreatic tissue. The piece of whalebone is inserted into one of the pancreatic branches of the hepatic artery, which has been opened into by ulceration, and the bleeding from which had caused death. (*R.I.M., Glas.*)



back, and then travelled to the side or the epigastrium. It never appeared to have any relation to food taken.

The severity of the pain and its period of appearance are very variable. In some instances it is very acute, doubling up the patient while it lasts. While it is said to appear usually from two to four hours after a meal, it sometimes occurs within half an hour.

Hæmorrhage, when present to any extent, is almost always manifested by a copious discharge of blood *per rectum*; in some cases it is accompanied with hæmatemesis, and, when so associated, more frequently than not leads to a mistaken diagnosis of gastric ulcer. In a case published by Allchin,<sup>1</sup> the patient, a man aged 43, had, two years previous to admission to hospital, passed a considerable quantity of blood *per rectum*. At that time there was no hæmatemesis. After no particular exertion he suddenly vomited an enormous quantity of blood and fainted. Death occurred in thirty-six hours. A diagnosis of gastric ulcer was made, but the post mortem revealed a duodenal ulcer, situated about one inch from the pylorus. In a somewhat similar case reported by Moore,<sup>2</sup> melæna was associated with hæmatemesis.

In estimating the relative diagnostic significance of hæmorrhage by the bowel and hæmorrhage by the mouth, bleeding from a gastric ulcer is likely to be more abundant by the latter than *per rectum*, while in duodenal ulcer the converse will probably be the case. In the case of recurrent small hæmorrhages from a duodenal ulcer, the blood passed *per rectum* will be tarry; while in similar bleedings from the stomach, the blood passed will be more altered in character from the action of the gastric juice.

It may be incidentally pointed out, in speaking of melæna, that copious hæmorrhage, even to the extent of proving fatal, may take place from the bowel as the result of causes other than ulceration connected either with the stomach or the duodenum. See 'Malignant Disease of the Colon and Rectum.'

**Prognosis.**—There is every reason to believe that, like gastric ulcers, these duodenal ulcers undergo cicatrisation. The obscurity and difficulty which attend their diagnosis

<sup>1</sup> *Trans. Path. Soc. Lond.* 1 87, vol. xxxviii. p. 144.

<sup>2</sup> *ibid.* 1887, vol. xxxiv. p. 98.

naturally render it impossible to say what proportion of cases recover. Bucquoy claims to have had four recoveries out of five cases. Planchard<sup>1</sup> reports a case where, after death from perforation, evidences of cicatrisation were seen around the ulcer, showing that the ulcer was an old one and had undergone considerable repair.

The interest of these cases to the surgeon centres rather in the complications which arise in the progress of the disease than in the simple uncomplicated disease itself. The question of the excision of a simple duodenal ulcer has not yet entered into the practical domain of surgery, as it has done in the somewhat analogous case of gastric ulcer. Up to the present the surgeon had mostly to deal with the results of ulceration, either in the way of perforation, or in its later after effects, stricture.

The occurrence of hæmorrhage generally lends a somewhat serious aspect to a case, and the more so the larger the quantity of the blood lost at any particular time. Not a few cases are recorded (Coats and Gairdner,<sup>2</sup> Allchin,<sup>3</sup> Hebb,<sup>4</sup> Moore<sup>5</sup>) where death has suddenly resulted from excessive hæmorrhage. In this particular class of cases the ulcer is always situated on the concave aspect of the bowel, adherent to the pancreas and having in its floor a perforation involving the gastro-duodenal artery or one of its branches.

Perforation of the ulcer into the general peritoneal cavity is, with the exception of severe and fatal hæmorrhage, the most serious complication. The ulcer in these cases is usually situated on the anterior part of the first portion of the duodenum, close to the pylorus, and therefore at a place where communication is at once established with the general peritoneal cavity. As a rule the perforation is from one ulcer; occasionally, however—as in a case reported by Biggs<sup>6</sup>—there are two ulcers, both of which have perforations.

This complication may arise as the first symptom of the disease. The patient may be enjoying perfect health when he

<sup>1</sup> *Annual of the Universal Medical Sciences*, 1889, vol. i. D—13.

<sup>2</sup> *Glasgow Med. Journ.* 1888, N.S. vol. xxix. p. 517.

<sup>3</sup> *Trans. Path. Soc. Lond.* 1887, vol. xxxviii. p. 144.

<sup>4</sup> *Westminster Hospital Reports*, 1891, vol. vii. p. 79.

<sup>5</sup> *Trans. Path. Soc. Lond.* 1883, vol. xxxiv. p. 98.

<sup>6</sup> *New York Med. Journ.* 1890, vol. li. p. 77.



PLATE XII.



Fig. 42.—PERFORATING ULCER OF DUODENUM.—The ulcer is situated about one inch beyond the pylorus. It is round in shape, and one-third of an inch in diameter. The base is formed of connective tissue. It had not caused symptoms during life. The patient died of heart disease. (*W.I.M., Glas.*)



is suddenly struck down with all the symptoms of acute perforative peritonitis. As in the case of gastric ulcer, perforation may take place at any time, but in some instances it is definitely connected with distension of the viscus. In two cases published respectively by Myers<sup>1</sup> and by Murray,<sup>2</sup> in one it occurred after a heavy bout of drinking, and in the other shortly after a heavy meal. So far as is known, every case of unoperated-upon perforation into the general peritoneal cavity has proved fatal sooner or later. Death may take place in a few hours or be delayed for a few days.

Rarer complications are such as result from the cicatrisation of the ulcer. A case is reported by Svenson and Wallis where the inflammatory thickening around the ulcer had given rise to obliteration of the common bile duct and cystic duct. The patient died of exhaustion. It is possible also for the hepatic and pancreatic ducts, the portal vein and hepatic artery to be obstructed. Cicatrisation of ulcers near the pylorus will give rise to symptoms similar to those due to obstruction at the pyloric orifice. A still rarer complication is the formation of fistulæ. Bucquoy, in his paper already quoted, refers to a case where a stercoraceous fistula formed at the umbilicus. West<sup>3</sup> also reports a case of abscess which formed between the ulcer and the colon, eventually bursting into the latter.

CASE LVII.—*Simple ulcer of the duodenum, with subsequent perforation.*

The patient was a gentleman aged 56, who for two or three years before his death suffered, at first occasionally and later almost daily, from pain to the right of the epigastrium. The pain always came on about two hours after a meal. Occasionally there were exacerbations of the symptoms, with pyrosis. Shortly before death he had several severe attacks of melæna, with occasional vomiting, the vomit containing sarcinæ. The fatal result occurred quite suddenly from collapse, within an hour or two after the perforation. At the necropsy a large ulcer was found situated on the anterior and left side of the duodenum, just beyond the pyloric orifice. He was seen during life by the late Dr. Wilson Fox, who diagnosed duodenal ulcer. In fact, during the later stages of the illness, the nature of the malady was manifest from the recurrence of the pain about two hours after each meal, its situation to the right of the epigastrium, and the melæna. (Eve, 'Lancet,' 1894, vol. ii. p. 1092.)

<sup>1</sup> *Trans. Path. Soc. Lond.* 1890, vol. xli. p. 101.

<sup>2</sup> *Ibid.*

<sup>3</sup> *Brit. Med. Journ.* 1893, vol. i. p. 732.

CASE LVIII.—*Simple ulcer of duodenum: no symptoms until perforation.*

M. C., aged 27, a well-built muscular man, was brought to hospital in an almost unconscious condition. He had been engaged at his usual work and apparently in perfect health till 12 noon on the previous day, when he was seized with violent abdominal pain, which doubled him in two. During the afternoon he vomited some reddish-coloured fluid, which was thought to be blood. He passed rather a sleepless night, suffering considerable pain, but was able the following morning to assist in dressing himself, preparatory to removal to hospital. On admission he was cyanosed, pupils were dilated, sweating on forehead, pulse almost imperceptible, abdomen somewhat distended and very tympanitic. Complete loss of liver dulness. It soon became impossible to feel the pulse at the wrist, and within fifteen minutes after admission respiration had ceased. At the post-mortem examination there was acute general peritonitis and a small round ulcer situated just at the commencement of the duodenum which had ruptured. (Parsons, 'Dublin Journal of the Medical Sciences,' 1892, vol. xciv. p. 27.)

**Treatment.**—In cases of simple uncomplicated ulcer the treatment resolves itself into one of careful feeding. The diet is limited mostly to milk, and the patient is kept at rest in bed. In cases of hæmorrhage, ergotin should be administered either by mouth or by hypodermic injection. The question of transfusion by normal saline solution should be entertained, and the remarks upon this method of treatment in connection with hæmorrhage from gastric ulcer will be equally applicable here. (See page 180.)

The chief interest to the surgeon, however, attaches itself to the treatment of those cases where perforation has taken place. It is only within comparatively recent years that operative interference has been considered. The success which has attended the surgical treatment of perforation in cases of gastric ulcer is, from the perfect similarity of the two diseases, a sufficient encouragement to hope for like good results in this condition; and, if further encouragement were required, the case brought before the Medical Society of London in May 1894 by Dean<sup>1</sup> is sufficient of itself to establish the practice of laparotomy as the proper procedure in all these cases. In the case here referred to, the operator succeeded in excising the ulcer and curing the patient. While up to the present this appears to be the only success which has

<sup>1</sup> *Brit. Med. Journ.* 1894, vol. i. p. 1014.

PLATE XIII.



Fig. 43.—PERFORATING ULCER OF DUODENUM.—Equal portions of the stomach and duodenum are shown, the pyloric ring being indicated by a transverse ridge. A piece of the left lobe of the liver is seen behind, into which the ulcer penetrated. (*W.I.M., Glas.*)



been obtained, attempts have been made in two cases by Lockwood<sup>1</sup> and in one by Eve;<sup>2</sup> and although unsuccessful they have not been without value in throwing some light which may prove of future service.

It is needless to give here in detail a line of treatment which in all respects resembles that already fully described in cases of perforation of gastric ulcer. The two main points to which the surgeon must direct his attention are the ulcer and the peritoneal extravasation. The ideal treatment of the former will be its removal and the closure of the orifice. Such was the treatment successfully carried out by Dean: 'The portion removed was elliptical in shape, measuring an inch and a quarter in its long axis, which was parallel with the transverse axis of the gut. The portion excised was found to include the ulcer and a margin of healthy mucous membrane. In the centre of the ulcer was a perforation about 2 mm. in diameter . . . the elliptical opening thus made in the duodenum was sewn up by silk sutures according to Lembert's method.' Cases, however, will occur where no such complete removal is possible. The surgeon will then have to consider whether it is advisable—if possible—to close the orifice by the passage of a series of Lembert sutures outside the area of the ulcer, approximating the serous surfaces and at the same time folding in the ulcer, as under similar circumstances of gastric ulcer; or whether he must be satisfied with proper washing out of the part, drainage, and stuffing the region with iodoform gauze to prevent further general extravasation.

With regard to the peritoneal cavity, it should be freely washed out with hot water, or, if preferred, with a warm weak solution of some antiseptic. Whether a drainage tube should be used and the abdominal incision not completely closed will depend much upon the efficiency with which ablution can be carried out. If there is any doubt as to this a drainage tube should be inserted and made to pass, as may seem advisable, either down to the seat of the disease, or into the cavity of the pelvis where extravasated material usually gravitates.

It may be remarked here with regard to the incision through the parietes, that if the operation is performed

<sup>1</sup> *Trans. Med. Soc. Lond.* 1892, vol. xv. p. 91.

<sup>2</sup> *Lancet*, 1894, vol. ii. p. 1091.

deliberately to deal with the duodenum, the incision should be in the median line above the umbilicus. Where, however, as most frequently happens, the operation is performed for a possible perforative peritonitis the cause of which is not known, the incision is made below the umbilicus, and must be extended upwards to afford efficient inspection and treatment of the duodenum. For proper drainage of the pelvic cavity, where this is deemed necessary, the tube must be brought out through an incision below the umbilicus.

The treatment of stricture as the result of a healed ulcer will be dealt with when discussing the subject of stricture itself.

The after treatment of cases of operation for perforative peritonitis will in all respects resemble that to be adopted in the analogous instance of perforation of a gastric ulcer. (See page 190.)

**Acute ulceration.**—In contradistinction to the slowly formed ulcer just described, there is a class of cases where the process is a comparatively rapid one. The patients in whom this form of ulceration is found have usually been the subjects of severe burns, involving as a rule a considerable part of the surface of the body. Occasionally, though rarely, it has happened in other affections, as, for instance, in septicæmia. Ever since Curling's memorable paper,<sup>1</sup> read before the Medico-Chirurgical Society of London in 1842, a lingering interest has always attached to the subject. Modern experience contrasts strangely with what seems to have occurred in Curling's time. This surgeon was able to collect no fewer than ten cases, which came under his observation within a comparatively few years; while at the present day there are not a few surgeons of large experience in hospital practice who have never met with a single instance. However, cases do crop up occasionally, sufficient to make it certain that there does appear something of the nature of true cause and effect.

Various theories have been promulgated as to the reason of this ulceration. Curling's original suggestion was that the extensive destruction of the skin led to an extra activity of Brünner's glands. The sweat glands of the skin being destroyed over a large area, an increased activity takes place in

<sup>1</sup> Society's *Trans.* 1842, vol. xxv. p. 260



the analogous Brünner's glands, and these latter being situated in that part of the duodenum which is most prone to inflammation, that is the first part, ulceration rapidly ensues.

The most recent contribution to the pathology of the condition is by Hunter,<sup>1</sup> who attributes the ulceration to the absorption of septic poisons which, being excreted by the bile, have an irritative effect upon the mucous membrane, and so give rise to acute congestion and ulceration. He bases his theory upon experiments performed upon dogs. Toluylenediamin was injected into the circulation of dogs, and after being killed, ulcers were found in the duodenum resembling those found after burns.

The occurrence of these ulcers in the same part of the bowel as those of the more simple or chronic type seems to suggest a similar cause, only one acting more acutely. The theory that the formation of the chronic ulcer is due to non-neutralised action of the acid gastric juice upon a limited area of the bowel, deprived of its normal blood supply by embolism or thrombosis in some small artery, would equally apply in the case of the acute ulcer. In this instance it is assumed that the same deprivation of blood supply takes place, owing to the absorption of septic material which readily conduces to the production of capillary embolism or thrombosis. The fact that ulceration appears to manifest itself usually at that stage when sloughs are separating and suppuration is most abundant would seem to give some support to the theory. For it is at this particular time that the blood, surcharged with effete material absorbed from the surface of the body, is most likely to clot and become the source of thrombosis or embolism. Such a theory would also well account for the rarity with which the complication is now met. For the modern antiseptic treatment of burns lessens largely the very condition which in earlier years proved such a serious stage in the later course of a severe burn.

There are no very marked characteristics of these ulcers. Situated as a rule close to the pylorus, they are usually single, although in some instances two, three, or more are met with. The mucous membrane of the bowel may be congested and inflamed, although the immediate surrounding of the

<sup>1</sup> *Trans. Path. Soc. Lond.* 1890, vol. xli. p. 105.

ulcer is sometimes free from inflammation. Their shape and size vary, sometimes round or oval, at other times quite irregular in outline. The margins of the ulcer are frequently sharply cut and undermined. They may cicatrise completely, or progress till perforation takes place, and then communicate either with an artery or with the general peritoneal cavity. In illustration of their cicatrising, a case may be cited, reported by Holmes,<sup>1</sup> of a child who had been severely burnt and died on the twenty-eighth day, apparently from an attack of pneumonia. At the post mortem a circular patch about the size of a four-penny piece was found at the commencement of the duodenum, where the mucous membrane was deficient and the exposed surface cicatrised. From this case, together with another similar one given by Curling, as also the fact of the frequent non-existence of symptoms in cases which may end fatally by perforation, Holmes considers it not improbable that ulcer may be a much commoner incident of burns than at present supposed, its existence being an unrecognised complication in many cases which recover.

The lesion, if it is to lead to a fatal result, usually does so, according to Curling, some time between the seventh and the seventeenth day. There are, however, many examples of this period being both shorter and longer. Out of sixteen fatal cases collected by Holmes, five died during the first week, five during the second, and the remaining six after longer periods. The shortest period was four days, while the longest was seventy-five.

Children appear to afford the majority of fatal cases; the instances, however, of death occurring late in life are not a few. As examples of the extremes of ages, one of Curling's cases was a child aged 3 years, and one of Holmes's a man aged 78 years.

There appears to be no definite relation between the region of the body burnt and the appearance of ulceration. Although in the majority of instances either the abdomen or the chest has been involved, in one case reported by Southam,<sup>2</sup> only the face, arms, and thighs were implicated. In two of Holmes's cases the extremities only had been burnt and in a

<sup>1</sup> *System of Surgery*, 3rd edit. vol. i. p. 395.

<sup>2</sup> *Lancet*, 1890, vol. i. p. 168.

case related by Morton<sup>1</sup> the lower extremities and the mucous membrane of the rectum alone had suffered.

**Symptoms.**—In nearly all the recorded cases there have been no symptoms to indicate the lesion in the bowel, until the occurrence of a severe hæmorrhage or of a fatal perforation. It is possible, as Curling suggests, that any symptoms which might otherwise manifest themselves are masked by or attributed to the more gross lesion on the surface of the body, or other general disturbances. A sense of discomfort amounting to pain might be expected to show itself in or to the right of the epigastric region, with some tenderness on palpation of the part. There may be some derangement in gastric digestion. Diarrhœa and vomiting may be present, although these may owe their appearance to other causes. The presence of blood in the vomit or stools will necessarily suggest the probable existence of ulceration; while the sudden onset of acute abdominal pain, with other symptoms of collapse, will leave little doubt that an ulcer has perforated into the abdominal cavity.

**Treatment.**—It is hardly possible to speak of the treatment of a disease the very presence of which it is frequently so difficult, if not impossible, to determine. When, however, there is reason to suspect the existence of ulceration, the diet should for some time be limited to milk and other mild fluid nourishment. Rest will hardly need to be enforced, for the patient will probably be incapacitated from exercising any movement, by reason of the surface condition of the body. Where possible, Curling suggests the application of leeches over the duodenum; and to allay pain, the administration at intervals of a few grains of grey powder combined with opium. The appearance of hæmorrhage will need to be combated by the usual hæmostatics: the administration of ergotin by the mouth or by subcutaneous injection.

When symptoms of perforation manifest themselves, the usual means now adopted for this complication arising from other conditions should be practised. The treatment does not appear to have been tried; but as the natural course of the complication is inevitably a fatal one: to open the abdomen, search for the perforation, and treat it and the general peritonitis

<sup>1</sup> *International Encyclopædia of Surgery*, vol. ii. p. 240.

can add no additional danger, but on the contrary may hold out some hope of a cure. It is fairly reasonable to believe therefore that, where the operation is performed promptly and carried out efficiently, there is as much likelihood of a good result accruing as in the case of perforation from the simple or chronic form of ulcer.

CASE LIX.—*Ulceration of the duodenum after a burn.*

The patient, a man aged 38 years, was admitted into hospital in October 1889. He had extensive burns about the face, arms, and thighs, which proved fatal on the twelfth day. For the first eleven days the highest temperature recorded was 103·2°. During the last twenty-four hours the temperature rose steadily and rapidly, until shortly before death the thermometer registered 110·2°. During the last few days he complained of pain and tenderness on pressure in the epigastric region. Otherwise there were no special features in connection with the case, nor were there any other symptoms indicative of the presence of duodenitis. At the necropsy the duodenum, especially at its commencement, was found deeply congested. Close to the pylorus were found two well-defined ulcers, irregular in shape, with slightly raised edges, the largest measuring an inch and a half by three-quarters of an inch. Their bases were formed by the muscular coat, the ulceration not extending deeper than the sub-mucous tissue. With the exception that there was marked congestion of both lungs, the other viscera were healthy. (Southam, 'Lancet,' 1890, vol. i. p. 168.)

---

## CHAPTER XXXIII

TUMOURS: INNOCENT AND MALIGNANT. STRICTURE. CONGENITAL STENOSIS AND OBLITERATION. PERFORATION FROM EXTERNAL CAUSES

**Tumours.**—Of the two great classes of tumours, innocent and malignant, the former is the one more commonly met with. Both, however, are extremely rare.

**Innocent growths.**—Tumours other than those of a malignant character are extremely rare. They may, however, prove equally as fatal in the obstruction which they cause. A case of fibro-myxoma of the duodenum is reported by Foxwell.<sup>1</sup> A woman aged 28 years suffered from symptoms akin to those of pyloric stenosis. After death a tumour about three times the size of a chestnut was found at the junction of the second and third parts.

<sup>1</sup> *Lancet*, 1889, vol. i. p. 1239.

**Malignant tumours.**—Primary malignant disease of the duodenum is, according to some statistics collected by Whittier,<sup>1</sup> only met with in one per cent. of all the cases where some part of the small intestine is involved. It may exist in the form of carcinoma or sarcoma. In the former case the disease originates most frequently about the orifice of the bile duct. As it progresses ulceration takes place, and obstruction may be caused either in the bowel or in the bile duct.

The form of carcinoma is most frequently of the cylinder-celled variety. In two specimens depicted by Kast and Rumpel,<sup>2</sup> the growth was examined microscopically and found to be a cylinder-celled epithelioma. In the thirteen cases of malignant disease collected by Whittier, there is no mention of any microscopical examination having been made. The various types of disease present are spoken of as scirrhus, encephaloid, spongy, or fungous.

When sarcoma attacks the duodenum, it as a rule travels round the bowel, so forming a mass which to some extent maintains the shape of the part, but through encroachment upon the interior soon lessens its calibre. The cells of which the growth is composed are usually small and round, and, from the occasional admixture of some few delicate fibrils, assume the character of a lympho-sarcoma. In some instances it appears as if the tumour arose in the submucous tissue, while in others its origin seems more likely to be from the neighbouring lymphatic glands. A case recorded by Rolleston<sup>3</sup> would illustrate the former, while one reported by Moore<sup>4</sup> would seem to suggest the latter; in this latter instance the mesenteric and lumbar glands were greatly enlarged.

Tumours having their origin elsewhere, and only secondarily involving the duodenum, must be distinguished from primary affections of the part. Clinically, however, such distinction may not be possible, the secondary implication of the bowel being the primary cause of the most prominent symptoms. Tumour therefore arising in connection with the head of the pancreas will soon seriously implicate the bowel.

<sup>1</sup> *Trans. of the Association of American Physicians*, 1889, vol. iv. p. 292.

<sup>2</sup> *Illustrations of Pathological Anatomy*, Part 3, English edit.

<sup>3</sup> *Trans. Path. Soc. Lond.* 1892, vol. xliii. p. 67.

<sup>4</sup> *Ibid.* 1883, vol. xxxiv. p. 99.

In a case reported by Cahn,<sup>1</sup> a mass of retroperitoneal glands had so pressed upon the lower part of the duodenum as to cause obstruction. A remarkable symptom was the large quantity of bile which was removed from the stomach after the first few washings had been carried out.

**Symptoms.**—It is not possible as a rule to indicate any symptoms which specifically indicate that they owe their origin to primary disease of the duodenum. The various symptoms which do show themselves are frequently as attributable to disease connected with the stomach, jejunum, or neighbouring parts.

The inevitable result of a growth, either carcinomatous or sarcomatous, is to produce a gradual diminution in the calibre of the bowel. Symptoms of obstruction, however, may not show themselves until a comparatively late stage of the disease, the reason of this being that the material which passes through the strictured portion is naturally of a somewhat fluid consistency. As soon, however, as obstructive influences come into play, various symptoms arise. Dilatation of the stomach follows, and this may be accompanied by a corresponding dilatation of the part of the duodenum above the obstruction. In one of Whittier's collected cases this dilatation had taken place to such an extent that there was no essential difference in size between the stomach and the first six or eight inches of the duodenum. A further result of increasing obstruction will be various gastric disturbances with vomiting. The gradually diminishing passage of material through the obstructed part will soon give rise to emaciation, and the patient will suffer from flatulence and colicky pains. External manipulation may indicate the presence of a tumour in the epigastric or right hypochondriac region.

In diseases which attack the region of the biliary orifice—that is, the second or descending part of the duodenum—obstruction to the outflow of bile may take place, with the result that jaundice, distension of the gall bladder, and other symptoms dependent thereon will become manifest. Ulceration may cause hæmorrhage, which will show itself either in the vomit or in the stools. Should the ulceration open up one of the pancreatico-duodenal arteries, a fatal result would ensue. Other causes of death are perforation and general peritonitis,

<sup>1</sup> *Berliner klin. Wochenschrift*, 1886, No. 22, p. 353.

acute intestinal obstruction, and gradual exhaustion, the last being the most frequent cause.

**Treatment.**—As purely palliative measures, much relief will be obtained by the use of suitable diet, and by periodically washing out the stomach. Radical measures can be less entertained than in other portions of the gastro-intestinal canal; only in the most exceptional instances of disease located near the pylorus is it possible to consider the question of extirpation. The deep situation and, above all, the intimate connections of the second and third parts of the duodenum with the pancreas, the blood vessels, and the hepatic ducts, render any such operation impracticable. It is, however, not unreasonable to consider that temporary relief might be afforded by the performance of gastro-enterostomy. The diversion of the food from the stomach to the jejunum should afford equal, if not greater, relief than in the case of pyloric stenosis for which the operation is usually performed.

**Stricture.**—Independently of the narrowing of the canal from disease within or from the pressure of tumours without, there are some cases where true cicatricial stenosis occurs. The comparatively large diameter of the canal, the fluid nature of the material which passes through it, together with the improbability that chronic ulceration ever extends sufficiently far even to produce serious narrowing, all tend to render obstruction from this cause of infrequent occurrence. In all cases cicatricial stenosis owes its origin to previous ulceration; and this again is either the result of gall stones or of those causes, whatever they may be, which give rise to the simple or chronic ulcer.

**Symptoms.**—The symptoms in the main are those of obstruction, but their character differs according to whether the stricture is above or below the orifice of the bile duct. Where the stricture is close to the pylorus, it is not possible to differentiate between this condition and that of pyloric stenosis. As the seat of obstruction, however, recedes from the pylorus, the character of the symptoms changes somewhat. Thus it has been found that after the stomach has been washed out and emptied, the patient would again vomit large quantities of material some few hours afterwards. The reason of this appears to be that a quantity of material lodges in the duodenum

at the time of washing out the stomach, but later it is returned and ejected. Some importance may also be attached to the variability which exists in the digestive powers of the gastric juice and in the proportion of free hydrochloric acid present. At one time the gastric secretion may contain free hydrochloric acid and possess active digestive properties, while at another the reverse will be the case. The explanation of this appears to be in the occasional regurgitation of the alkaline juice of the duodenum into the stomach, and so a neutralising of the acid and an interference with the normal digestive properties of the secretion. Boas<sup>1</sup> reports a case of constriction from chronic ulcer. The stomach pump when used on one occasion removed about a quart of dark, bilious, odourless chyme, the microscopical examination of which showed neither torulæ nor sarcinæ. The reaction was slightly acid, but no free hydrochloric acid was detected. Much peptone and egg-albumen were present, and fibrin was easily digested by it. In stricture situated below the orifice of the bile duct there will be a regurgitation of bile into the stomach, with interference with digestion, and the presence of bile in the vomit.

Hochhaus,<sup>2</sup> who in his report of three cases has devoted considerable attention to the subject of duodenal stenosis, attaches some importance to the existence of a previous history of gall stones. In each of his three cases the ulceration was due to gall stones. In his first case the stenosis was close to the pylorus, in the second it was at the junction of the duodenum and the jejunum, and in the third it involved both the duodenum and the pylorus.

Lange<sup>3</sup> reports an interesting case of stenosis from the cicatrisation of a chronic ulcer situated close to the pylorus. The patient, a woman, had for long suffered from symptoms which suggested ulcer of the stomach, for which she was treated. Later her condition was such as to indicate stricture about the pylorus. Additional interest attaches to this case from the fact that the stricture was successfully dealt with by the performance of pyloroplasty (Heineke-Mikulicz) or, as it should be more properly termed, duodenoplasty.

<sup>1</sup> *Annual of the Universal Medical Sciences*, 1892, vol. i. D—11.

<sup>2</sup> *Berliner klin. Wochenschrift*, 1891, No. 17, p. 409.

<sup>3</sup> *Annals of Surgery*, 1893, vol. xvii. p. 588.



**Treatment.**—It is hardly possible to do more than suggest a line of treatment in a class of cases so rarely met with and still more rarely treated. But the success which attended Lange's case sufficiently indicates the proper course to follow in all similar instances. Where an exploratory laparotomy reveals constriction of the bowel lower down, it is possible that a like plastic operation might be performed. When it is remembered that life can only be retained by securing a proper flow of the bile and pancreatic secretion downwards into the lower bowel, something may reasonably be attempted to bring this end about.

**Congenital stenosis and obliteration.**—Cases now and then crop up where a child lives for three or four days after birth and then dies with symptoms of obstruction. At the post mortem, failing the evidence of a stoppage elsewhere, either stricture or a complete obliteration is found in some part of the duodenum. Judging from the very few cases recorded, the condition must be a rare one, and when it is met with, the symptoms are not such as to point to the duodenum as the part where the obstruction is seated.

The child at birth may present all the appearances of good health, but on the second or third day it begins to refuse the breast and vomits, bringing up at first, it may be, a little mucus with the contents of the stomach, but later this is mingled with bile if the obstruction be below the orifice of entrance of the duct. In one case it had the appearance of meconium, and in two some blood was present. Meconium may pass *per rectum*.

The situation of the constriction or obliteration appears more frequently in the upper part of the bowel. In a case recorded by Anderson,<sup>1</sup> about one inch of the duodenum close to the pylorus was absent, each end above and below the deficiency formed a perfect cul-de-sac. In another case, by Hobson,<sup>2</sup> the duodenum ended about one inch beyond the pylorus in a blind pouch, and on tracing the bowel upwards it was also found to end in a cul-de-sac, at the top of the head of the pancreas. In a third case, reported by Emerson,<sup>3</sup> a tight constriction almost, but not quite, occluded the bowel

<sup>1</sup> *New York Medical Record*, 1889, vol. xxxv. p. 329.

<sup>2</sup> *Brit. Med. Journ.* 1893, vol. i. p. 637.

<sup>3</sup> *New York Med Journ.* 1890, vol. lii. p. 153.

just above the orifice of the bile duct. In a fourth case, by Porak and Bernheim,<sup>1</sup> the stomach communicated by a contracted pylorus with a blind pouch which terminated near the pancreas.

The primary cause of these conditions can only be conjectural, but it is probable that those cases in which a certain part of the bowel appears absent, and the ends terminate in cul-de-sacs, owe their origin to some defect in development; while those in which there is stenosis, it is probable that the constriction owes its origin to the cicatrisation of a simple or chronic ulcer, since such ulceration—as has been already pointed out—is occasionally found in the new-born child.

**Diagnosis.**—The cases have been too few to form a basis for any diagnostic purposes. Only an approximate diagnosis can be arrived at, and that mostly by exclusion. With symptoms of obstruction, the surgeon should first examine the rectum, digitally and by means of a gum-elastic catheter; if these fail to find any obstruction, fluid may be injected and note taken of the amount introduced before its return. The passage of meconium in any quantity will probably indicate obstruction high up. When evacuations *per rectum* take place, sweet oil may be given by the mouth, and the motions carefully examined for its presence. Emerson tried this means; oil was administered twice, but nothing appeared in the evacuations. The character of the vomit should be carefully noted; continuous ejections without evidence of bile or meconium will possibly prove one of the best signs that the obstruction is situated in the upper part of the duodenum.

**Treatment.**—The continuance of the symptoms, with the inability to arrive at a diagnosis, will probably tempt the surgeon to perform an exploratory laparotomy. Not much harm can come of it, nor much good either, except that the surgeon and the friends may have the satisfaction of knowing that life under no circumstances could be maintained.

**Perforation of the duodenum from external causes.**—The duodenum, like the stomach and other parts of the intestine, may be perforated by inflammatory mischief arising in its immediate neighbourhood. Rolleston<sup>2</sup> showed a specimen

<sup>1</sup> *Annual of the Universal Medical Sciences*, 1892, vol. ii. L—15.

<sup>2</sup> *Society's Trans.* 1891, vol. xlii. p. 186.

before the Pathological Society of London of a tubercular perinephric abscess which had ulcerated into the duodenum by two or more openings situated about the lower part of the second portion and the commencement of the third.

---

## CHAPTER XXXIV

### OPERATIONS

DUODENOSTOMY  
DUODENECTOMY

DUODENOTOMY  
DUODENOPLASTY

**Duodenostomy.**—The operation of establishing a permanent fistula in the duodenum in cases of obstruction at the pylorus, or of extensive disease in the stomach, has only been performed some few times. Theoretically the opening would appear to be at the best position for feeding the patient, but practically the operation proves much less easy of execution than jejunostomy or gastro-enterostomy, when either of the latter can be adopted as a substitute. The operation has found but little favour with surgeons, and, while fatal in the few instances in which it has been practised, it can hardly be considered to have received a fair trial. It was originally introduced and practised by Langenbuch<sup>1</sup> in 1879. In 1883 it was performed in this country by Robertson,<sup>2</sup> in 1884 by Southam,<sup>2</sup> and Solis-Cohen.<sup>3</sup> refers to a fourth case operated upon by Surmay.

*Operation.*—The abdomen is opened by an incision in the middle line above the umbilicus. The pylorus is felt for, and the duodenum identified. The latter is then brought up to the wound and secured there by a circle of silk stitches, which pass through the entire thickness of the abdominal parietes, but only through the serous and part of the muscular coats of the bowel. When the stitches are tied, the visceral and parietal serous surfaces should be perfectly coapted. A stitch or two is placed at each extremity of the abdominal wound so as to close it to the required extent. In the course of a few

<sup>1</sup> *Berliner klin. Wochenschrift*, 1881, No. 17, p. 235.

<sup>2</sup> *Brit. Med. Journ.* 1884, vol. i. p. 1146.

<sup>3</sup> *International Encyclopædia of Surgery*, vol. vi. p. 4

days the operation is completed by opening the bowel. In Langenbuch's case the operation was performed on September 4, 1879, the opening into the bowel was made on the 11th, and the patient died of exhaustion on the 14th. In Robertson's case the patient was greatly exhausted at the time of the operation, and died about twelve hours afterwards from shock. In Southam's case, owing to the very collapsed condition of the patient, the bowel was opened on the third morning, but death followed from exhaustion in the evening. At the post mortem there was no peritonitis, and the parts were firmly united.

The preparation of the patient, the treatment during the period between the first and second operations, and the after treatment are in all respects similar to what is done in the operation of gastrostomy, reference to which should therefore be made. (See page 232.)

**Duodenectomy.**—The operation of removing portions of the duodenum has up to the present been still more rarely practised than the operation just described. The most successful instance of its performance is the case already quoted of Dean's,<sup>1</sup> where a duodenal ulcer was excised.

*Operation.*—The abdomen is opened and the duodenum exposed as in the operation of duodenostomy. The excision of the part and the closure of the visceral wound will be carried out as already described when referring to Dean's case. (See page 282.)

**Duodenotomy.**—The operation for merely opening the duodenum and then reclosing the aperture exists more in name than in practice. The operation, however, is one that would be employed for the removal of a foreign body.

**Duodenoplasty.**—The operation in all its details resembles pyloroplasty (see page 265). It is employed for cicatricial stricture of the duodenum. The stricture is divided completely through in the long axis of the bowel, and the raw edges reunited in the transverse axis. It has been successfully performed by Lange. (See page 292.)

<sup>1</sup> *Brit. Med. Journ.* 1894, vol. i. p. 1014.

## SECTION II

## THE JEJUNUM AND ILEUM

## CHAPTER XXXV

## ANATOMY AND PHYSIOLOGY

**Anatomy.**—The remaining part of the small intestine comprises the jejunum and the ileum, the jejunum forming the upper two-fifths and the ileum the remainder. The two portions run imperceptibly into each other, although at their opposite extremities there are features sufficiently distinctive of each. The average length of the combined parts in the adult is about nineteen feet. Commencing at the termination of the duodenum, on the left side of the second lumbar vertebra, the bowel forms numerous convolutions, and ends in the cæcum in the right iliac fossa. These coils occupy the middle and lower part of the abdomen, and are surrounded by the large bowel. The jejunum is chiefly situated in the umbilical and left iliac regions, while the ileum mostly occupies the umbilical, hypogastric, right iliac, and sometimes the cavity of the pelvis. As broad points of distinction between the two portions, the jejunum is thicker in its coats, larger in calibre, and, from its greater vascularity, deeper in colour.

The mesentery attaches the intestine to the spinal column, the line of connection being from the left side of the second lumbar vertebra obliquely to the right sacro-iliac synchondrosis. At its attachment to the vertebra it measures about six inches, and its breadth between the column and the bowel averages four inches.

**Structure.**—The wall of the bowel consists of four coats—serous, muscular, submucous, and mucous.

The serous or peritoneal coat completely surrounds the gut, except at its line of reflection to form the mesentery. At this border the vessels and nerves enter the bowel, and the lacteals leave it.

The muscular coat is made up of two layers of involuntary muscle—an external and thinner one consisting of longitudinal fibres, and an internal and thicker composed of circular fibres.

The submucous coat consists of loose cellular tissue, connecting together the mucous and muscular coats, and serving as a support for the blood vessels prior to their final distribution, and for the larger lacteal spaces at the bases of the villi and solitary glands.

The mucous membrane which lines the bowel is very loosely attached by means of the lax submucous coat beneath, and is thrown into numerous folds and projections, the *valvulae conniventes* and villi. The surface of the mucous membrane is covered by a single layer of columnar-shaped epithelial cells, which is uniform throughout its distribution.

The following are the structures contained within or forming part of the mucous membrane, and which constitute the special features of this portion of the small intestine :

*Valvulae conniventes.*—These are reduplications of the mucous membrane. They extend throughout the jejunum, but begin to disappear towards the middle of the ileum. Where most typically represented they extend round the bowel for nearly two-thirds of its circumference, and are about one-third of an inch in breadth. Their functions are to retard the passage of the chyme and to increase the absorptive surface of the bowel.

*Villi.*—These are minute vascular projections which extend throughout the entire length of jejunum and ileum, becoming less marked, however, as the end of the latter is approached, and being more or less absent from the surface of Peyer's patches. Their intimate structure must be studied elsewhere, but it may be briefly indicated that they contain an intricate network of blood vessels, with a large lacteal running down the centre. Their chief function is concerned in the process of absorption.

*Simple follicles, or crypts of Lieberkühn.*—These are minute tubular glands disposed perpendicularly to the surface of the mucous membrane. They exist throughout the entire length of the intestine and are situated between the villi, and only around and not upon Peyer's patches.

*Brünner's glands.*—Only a few of these glands are found at the commencement of the jejunum, their principal seat being in the duodenum. They are located in the submucous coat, and their ducts open upon the surface of the mucous mem-

brane. They secrete a material which, as a component of the succus entericus, takes some part in the process of digestion.

*Solitary glands.*—These are found throughout the small intestine, and consist of lymph follicles composed of a dense retiform tissue containing numerous lymph corpuscles.

*Peyer's patches* consist of collections of solitary glands which form circular or oval patches varying in length from half an inch to four inches. They are found mostly in the lower part of the ileum, are most common in early life, and often disappear in old age. They are usually free from villi upon the surface, and are surrounded at their margins with Lieberkühn's glands.

**Vascular supply.**—The arteries which supply the small intestine are derived from the superior mesenteric. Appearing at the lower border of the pancreas, the trunk of the vessel passes between the two layers of the mesentery. Here it divides into numerous branches which uniting together form a series of loops with their convexities turned towards the bowel. From these loops other vessels are given off, which uniting together form another series of arches, a process of distribution which is repeated some three or four times. As the border of the bowel is reached the terminal branches take a straight direction, passing round the bowel and anastomosing with each other. The veins have a similar course to that of the arteries. The main trunk joins with the splenic vein to form the portal.

**Lymphatic or lacteal system.**—The radicles of the lymphatics or lacteals commence in the villi and the lymph spaces around the solitary glands. They unite together at the mesenteric attachment and pass to the mesenteric glands, whence they proceed to form two or three large trunks which enter the thoracic duct.

**Nerve supply.**—The small intestine is supplied through the sympathetic nervous system, and through that particular portion of it which forms a plexus surrounding the artery of the same name, the superior mesenteric. This plexus is a continuation of the solar plexus, and is therefore placed in connection with the greater splanchnic and the right vagus, all of which are intimately associated with the semilunar ganglia.

**Physiology.**—With the intricate process of digestion carried on in the jejunum and ileum there is no need to deal. The contents of the stomach as they leave that organ do so in the form of a thin pulraceous chyme, semi-fluid in consistence, and acid in reaction. This acidity gradually diminishes as the chyme becomes mixed with the alkaline secretions of the liver, pancreas, and intestinal glands until about the middle of the ileum, when the whole content of the gut is alkaline in reaction, and remains so until it reaches the ileo-cæcal valve.

At the lower end of the ileum the content of the bowel assumes a light yellow colour and possesses a markedly fæcal odour.

The propulsion of the chyme through the bowel is effected by the peristaltic or vermicular action of the muscular coat. The contraction may be limited to sections only of the canal; it is produced by the contents of the intestine exciting a reflex action through the intestinal ganglia. Other stimuli are conveyed through the right vagus and greater splanchnic nerves.

---

## CHAPTER XXXVI

INJURIES. CONTUSION: ACUTE AND CHRONIC ENTERITIS, ULCERATION AND SLOUGHING, STRICTURE. RUPTURE

**Contusion.**—Any severe blow upon the abdomen may cause bruising of the bowel, and the injury inflicted is greater or less according to the force of impact, the nature and shape of the agent producing the injury, and the condition of the bowels at the time. The kick of a horse upon a loaded intestine would cause a much severer contusion than a blow by a fist upon an empty bowel.

A contusion in its simplest form merely consists of a congestion of the walls of the bowel, with rupture of some capillary blood vessels—a condition resembling in all respects a bruise of any soft part. In its severest form it leads to sloughing and gangrene of the injured part. Between these two extremes certain inflammatory changes may take place. If acute inflammation set in, the symptoms of acute enteritis



arise; and if the inflammatory process proceeds more slowly, evidences of chronic enteritis become manifest.

**Symptoms.**—No special symptoms can be said to point to contusion pure and simple. The pain and collapse from which the patient may suffer may as likely indicate a rupture of the bowel as it may an uncomplicated contusion of the abdominal wall. It is only in the progress of the case that some clue may be obtained to the true nature of the injury. As will be pointed out in the case of rupture, contusion may be unaccompanied by any external manifestation of injury to the abdominal parietes.

**Acute enteritis.**—The appearance of traumatic enteritis will be known by the onset of symptoms peculiar to that condition when arising from other causes, and for which a fuller description should be sought in books on medicine. The appearance of such symptoms as offensiveness of the breath, furring and dryness of the tongue, aching and griping, nausea and vomiting, diarrhoea, and the usual attendants of fever should suggest to the surgeon the possible nature of the affection.

**Chronic enteritis.**—Here also, as the symptoms significant of this condition are more frequently met with by the physician when arising from other causes, medical works should be consulted. The surgeon may reasonably suspect the existence of such a condition when the patient begins to suffer some days or weeks after the accident from offensive evacuations, with excessive secretion of watery mucus, griping pains, and gradual emaciation from imperfect intestinal digestion and absorption. In less marked instances it is sometimes difficult to distinguish between such a condition and some local chronic peritonitis.

Prolonged chronic inflammation may lead to cicatricial stricture, and this to the symptoms of a gradually increasing obstruction. A remarkable illustration of such a sequel to contusion of the bowel is recorded by Braillet, and is referred to by most writers upon the subject.

CASE LX.—*Acute obstruction from cicatricial contraction of the bowel following upon injury.*

A man, about 65, was thrown off his horse on to the handle of his sword, and violently struck the abdomen two fingers off the umbilicus. He suffered acute pain. At the end of four months he had frequent

vomitings, with pain like colic, especially at the seat of the injured spot. These were relieved; but fifteen months after the accident the same symptoms reappeared, and increased until he had stercoraceous vomiting. The motions were at first narrow in shape, then lessened in quantity, until absolute constipation resulted. At this time it was considered by some that the patient was suffering from volvulus. Braillet, however, maintained the opinion that the bowel had become contracted as the result of the injury. The man died with all the symptoms of acute obstruction. The post mortem revealed a contracted condition of the jejunum for six inches; above the stricture the bowel was dilated and contained the metallic mercury and leaden balls which had been administered prior to death. (From Poland's paper on 'Contusions of the Abdomen,' in the 'Guy's Hospital Reports,' 1858, 3rd series, vol. iv.)

John Gairdner reported a case to the Medico-Chirurgical Society of Edinburgh which would appear to come under the same category. In this instance, however, the fæcal accumulation in the dilated portion of the bowel above the stricture led to ulceration, and this to perforation, with death from acute peritonitis.

CASE LXI.—*Ulceration and perforation above a traumatic stricture of the jejunum.*

Thomas Kay, aged 24, was run over by a loaded cart, the wheel passing over the abdomen. Pain was complained of in the left hypochondriac region. In about a week after the accident dysenteric symptoms came on, with rigors, sweating, occasional vomiting, pain in the abdomen, particularly in the left iliac fossa, and dark fetid stools. After treatment the patient was discharged at the end of the third week, relieved. A month after the accident, he complained of severe griping pains in the epigastrium, with considerable flatulent distension in that region, of dysuria, and of thirst. The stools were rather liquid, and small in quantity. These symptoms subsided, but only to recur again a few weeks later. Three months after the accident he was suddenly seized with acute pain in the abdomen: this continued until he died, about thirteen hours later. The post mortem showed a part of the jejunum which was ulcerated through; the part of the bowel above the ulcer was greatly dilated, reaching in some places to nearly the size of the colon, and distended with fluid feculent material. Some fæces had extravasated into the general peritoneal cavity. (John Gairdner, 'Edin. Med. and Surg. Journ.' 1835, vol. xlv. p. 281.)

**Ulceration and sloughing.**—A blow which at the time is sufficient to devitalise a part of the bowel, will sooner or later be followed by separation of the part. As this sequel to a blow only results from a severe injury, it is not infrequently found in association with rupture. One part of the bowel may

be torn, while another will be badly contused, and it is often a matter of considerable difficulty for the surgeon to determine whether or not the contused portion should be left to itself, or as efficiently dealt with as the ruptured part. So many cases have now been reported where serious and fatal symptoms have come on some days after the injury and been found to be due to a perforation through a gangrenous patch of bowel, that it behoves the surgeon to look for and consider well the propriety of treating efficiently any badly bruised part.

The consequences of ulceration and sloughing of the bowel may be conveniently considered under four heads.

*First*, where the bruised bowel becomes adherent to the abdominal parietes, and it and the latter giving way an artificial anus is formed. The complication is a rare one, because it so seldom happens that the abdominal parietes are sufficiently seriously injured to give way by subsequent sloughing. In most instances, a blow severe enough to devitalise a part of the abdominal wall would almost certainly rupture the gut. Poland, however, instances the case of a man who was struck in the abdomen by a splinter of shell. The integument was bruised. On the sixth day the skin sloughed, and fæces passed through the opening.

*Second*, where the bowel becomes adherent to the abdominal parietes, but the latter remaining intact, an abscess forms at the seat of contusion. Such a result ensued in the second of two cases of injury to the intestine reported by Page.<sup>1</sup> Death resulted immediately from rupture of the bowel ten days after the accident, but the blow was received in the left iliac region, and all the patient's earlier symptoms were referable to this region. At the post mortem, a large collection of pus was found in the left iliac fossa.

*Third*, where no such adhesion to the parietes takes place, but the separation of the slough leads to a communication with the general peritoneal cavity, and acute fatal peritonitis follows.

By far the largest number of cases come under this head. The usual history of the case is that after the patient has recovered from the shock, the immediate result of the injury, recovery apparently takes place. The pain gradually becomes less, vomiting ceases, and the bowels move, and just when

<sup>1</sup> *Trans. Clin. Soc. Lond.*, 1888, vol. xxi. p. 251.

hopes are entertained that all danger is past, the patient is suddenly struck down with all the symptoms of acute perforative peritonitis. The time at which such perforation takes place varies. In a case reported by Targett,<sup>1</sup> it occurred on the fourth day. At the post mortem, the ileum was found glued to the spine on the left side of the fourth lumbar vertebra. Page<sup>2</sup> similarly reports a case of perforation on the fourth day from the date of injury. In another case, recorded by Atlee,<sup>3</sup> the patient was doing well on the tenth day when he got up to go to stool. On returning, he was tripped up by his blanket and fell; immediately after, he was seized with severe symptoms which proved fatal in two hours. At the post mortem, a jagged-edge hole, large enough to admit the tips of four fingers, was found in the intestine lying to the right of the median line, midway between the umbilicus and the pubes.

*Fourth.* Poland, in his well-known article already referred to, gives three cases where portions of the bowel were cast off and passed *per rectum*. The patients all recovered. It is difficult to understand how this process of separation has been effected, except on the assumption that the injured part must some time subsequently have become intussuscepted; and the explanation becomes the more probable when it is noted that in each instance it was a complete segment of bowel that passed, measuring not less than ten inches. In the first case the passage of the segment was after 'some weeks;' in the second on the eighteenth day; and in the third, about a year after.

**Treatment.**—Contusions of the abdomen giving rise to serious symptoms immediately after the receipt of injury should all receive, at first, the same treatment. Rest, and nothing by the mouth, should be the rigid rule of practice. If the collapse be so profound that stimulants appear imperatively necessary, these should take the form of brandy by the rectum or ether subcutaneously. As the primary collapse passes off, the question of laparotomy will arise. If the indication is in the direction of a gradual subsidence

<sup>1</sup> *Trans. Path. Soc. Lond.* 1887, vol. xxxviii. p. 143.

<sup>2</sup> *Trans. Clin. Soc. Lond.* 1888, vol. xxi. p. 251.

<sup>3</sup> *Medical Press and Circular*, 1885, N.S. vol. xxxix. p. 166.

of the acute symptoms, then active measures may be delayed, and the patient's strength maintained by the administration of nutrient enemata. Nothing, not even ice, should be given by the mouth, as everything taken into the stomach is liable to excite peristalsis of the bowel. This method of treatment must be carried out as long as possible, as long indeed as the patient's strength appears likely to allow. To more effectually obtain rest for the bowel, opium should be added to the nutrient enemata.

In the event of laparotomy being performed, the greatest difficulty may arise in determining whether or not the injured part should be excised. Experience would seem to teach that when in doubt it would be wiser to remove the part than leave it. As already shown, the commonest result of sloughing or gangrene of the bowel is fatal perforative peritonitis. If in any case the injury has been severe enough to rupture the bowel in one part, it is the more likely that a contusion found elsewhere will subsequently perforate. Hence in these particular instances the conditions may be deemed of a more critical nature than in those of uncomplicated bruising.

The after treatment of cases operated upon must be on the same strict lines of perfect rest. So long as the patient can live by rectal alimentation, nothing should be administered by the mouth.

**Rupture.**—The same causes which produce contusion of the bowel may give rise to rupture. The severity of the injury, and the nature of the body producing it, are the principal factors in determining the occurrence of rupture in place of contusion. Where in any case, therefore, the blow has been sufficient to knock the patient down, or dislodge him for some feet; where a fall has been from some height; where the wheel of a heavy or heavily laden vehicle has passed across the abdomen; or where a very tight squeeze or jam has occurred, suspicions should be entertained, however slight perchance may be the symptoms, that some injury graver than that of contusion has taken place. As has already been pointed out in the case of contusion, so here does it apply with equal, if not greater force, that the condition of the bowel at the time of the accident materially affects the nature and

extent of the injury, a loaded intestine being more likely to be ruptured than an empty one, and the lesion itself graver.

The nature of the lesion produced in any case may vary in regard to extent, from the size of a small puncture through which the intestinal contents will not exude, to a complete breach of continuity. The bowel may be ruptured at the point of impact, or at some distance from it. In the former instance there is likely to be considerable contusion of the margins of the rent, which may be jagged and irregular, or more or less of the nature of an incision. In the latter, while the tear may be clean cut or irregular, the margins of the aperture are usually free from bruising. In both cases there is the possibility of some rent in the mesentery, a lesion the existence of which is usually indicated by the presence of considerable intra-abdominal hæmorrhage.

Regarding the relative frequency with which the two parts of the small intestine are involved, it would appear that the ileum is somewhat more frequently ruptured than the jejunum. In Poland's paper<sup>1</sup> published in 1858, thirty cases of ruptured small intestine are recorded, of which sixteen comprised the ileum and fourteen the jejunum. In Croft's tables<sup>2</sup> published in 1890, out of ten cases collected between 1873 and 1890, seven were cases of rupture of the ileum and three of the jejunum. And out of ten cases which I<sup>3</sup> have found recorded since 1890, six were ruptures of the ileum and four of the jejunum. In many reported cases it is simply stated that the small intestine was injured, without particularising the region; only those cases therefore have been selected where the position of the rupture was stated, and confirmed either by operation or at the post mortem. Cases also of ruptured bowel in a hernial sac have not been included. The only practical value of these statistics is to show that, while the ileum is slightly more often injured than the jejunum, the difference is not sufficiently marked to warrant the surgeon, at the time of operation, investigating more carefully one region than the other. There is nothing to show that the ileum is

<sup>1</sup> *Guy's Hospital Reports*, 1858, 3rd series, vol. iv. p. 143.

<sup>2</sup> *Trans. Clin. Soc. Lond.* 1890, vol. xxiii. p. 147.

<sup>3</sup> Cases of ruptured jejunum: White, Hood, Battle, Maylard. Cases of ruptured ileum: Conley, Griffith, Templeman, Rockwell, Esson, Wiggin.

PLATE XIV.



Fig. 44.—RUPTURE OF JEJUNUM.—The rupture was seated about twenty inches from the duodenum, and was the result of a fall across a bar. (*W.I.M., Glas.*)

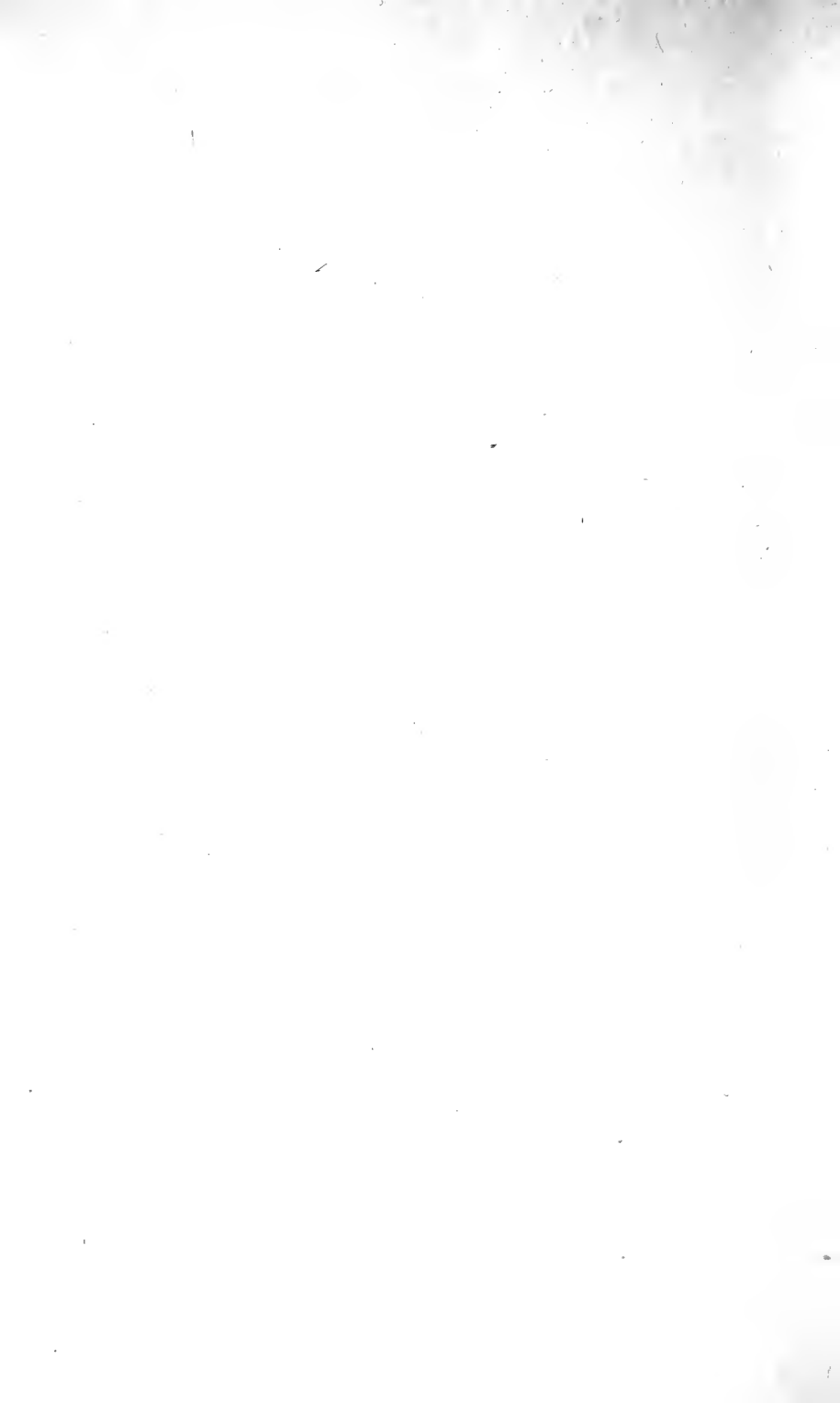



more frequently injured in one part than another, but in the case of the jejunum it is the upper part or that nearest its commencement that most frequently suffers. The left hypochondriac region, then, is always a part to be carefully explored.

**Symptoms.**—The immediate result of the injury is to produce more or less shock. The degree of the shock produced is frequently, however, no indication of the severity of the lesion. So far indeed does this appear from being in any sense a symptom peculiar to rupture, that it seems reasonable to believe that it is in some instances the result rather of a powerful emotional effect produced by the consciousness of a severe injury, than of any special lesion acting in a particular way. Considered therefore in this aspect, shock must often be looked upon as a symptom not so much of any grave effects of the injury as of a peculiar nervous susceptibility possessed by the patient. As illustrating this view of the nature of shock, a case recorded by Stimson<sup>1</sup> may be instanced. A patient was shot by a revolver; the shock was so profound that when the patient was admitted into the hospital he was apparently moribund. On making an examination, the bullet was found only to have perforated the patient's clothes, the skin of the abdomen being untouched. On the other hand not a few cases are recorded where grave lesions have occurred, but there has been an entire absence of shock. Thus in a case reported by Conley<sup>2</sup> there was no sign of shock, although the blow by a flying piece of plank from a circular saw had been sufficient to throw the patient several feet; later in the day signs of shock came on, and after three days death occurred, when, at the post mortem, a rent about an inch long, with ragged and contused edges, was found in the ileum. Another case is recorded by Robson.<sup>3</sup> A man fell about ten feet; he was stunned for a minute, but afterwards got up and walked a distance of two miles. He died on the third day, when a rent an inch long was found in the small intestine. It will be seen from these cases that but little diagnostic value can be attached to the symptom of shock.

<sup>1</sup> *Annals of Surgery*, 1894, vol. xix. p. 91.

<sup>2</sup> *Boston Med. and Surg. Journ.* 1890, vol. cxxiii. p. 225.

<sup>3</sup> *Trans. Clin. Soc. Lond.* 1888, vol. xxi. p. 122.

Pain is almost always present, although it may vary considerably in severity and situation. If masked at first by shock, it usually supervenes later, when it may be of a most acute character, causing the patient to 'double up.' Pain, when thus acutely felt either immediately after the injury or as the primary shock passes off, is aggravated by movement, respiration, and physical examination. It is often complained of most, immediately over the seat of the rupture; at other times it radiates over the whole abdomen, and when thus diffused it fails to afford any clue as to the probable situation of the lesion. To secure immobility the parietal muscles are thrown into contraction, so that the surface of the abdomen often appears rigid and retracted.

Vomiting, while not a constant symptom, is more frequently present than absent, and often occurs immediately after receipt of the injury. When present it usually persists and, in those cases in which recovery does not take place, continues until death. The presence of blood in the vomit is rarely met with; when present, it is likely to come from rupture high up in the jejunum. It must be remembered, however, that the presence of blood is much more significant of rupture of the stomach than of the small intestine.

The state of the pulse and the temperature is more dependent upon the amount of shock than upon the actual injury done. When the shock is at all severe, the pulse may become feeble, quick, irregular, and small, while the temperature may sink below normal. Respiration is sometimes quick, laboured, and shallow. It is painful because the movements involved are apt to act upon the injured parts. It is noticed therefore that breathing is principally thoracic.

The loss of the usual area of liver dulness is one of the most important symptoms of rupture of some part of the abdominal alimentary canal. It is as much significant of rupture of the stomach or large intestine as it is of the small. It indicates that gas has escaped and probably is escaping from the perforated viscus. When it exists to any large extent, the abdomen becomes distended and tympanitic. In exceptional instances, it has been known to make its way into the cellular tissues of the abdominal parietes and other more distant parts. Thus in a case of ruptured ileum about three inches from the

ileo-cæcal valve, recorded by Templeman,<sup>1</sup> emphysema occurred in the front of the abdomen and chest, in the neck and face, the shoulder and upper part of both arms, the scrotum and penis, and the upper part of both thighs. The scrotum and penis were enormously enlarged, being three or four times their normal size.

Retention of urine, while a symptom of no significance, is occasionally present. Defæcation sometimes takes place.

In general appearance the patient is frequently much distressed, with pallor of face and anxious expression. The skin surface may be pale and cold, with beads of perspiration on the forehead. The skin over the abdomen frequently shows no evidence whatever of the grave lesion produced deeply. If not restless, he will lie in bed with his knees drawn up and thorax raised so as to relieve any pressure upon the abdominal contents. Great thirst is frequently complained of.

As the primary shock passes off and the patient becomes more conscious, symptoms of acute general peritonitis begin to appear in from twelve to twenty-four hours from the time of receipt of the injury.

CASE LXII.—*Rupture of the jejunum at its middle. Death in twenty-eight hours.*

A miner aged 17 was crushed in a pit. When first seen, at 8.45 A.M., he was in a very much collapsed condition, the pulse at the wrist being almost imperceptible. He lay on the bed with his knees drawn up, and complained of severe abdominal pain. The abdomen was rigid and boardlike, but presented no bruise. The tenderness and rigidity were most marked in the left umbilical and lumbar regions. No abdominal dulness could be detected, and the liver dulness was absent. At 10.45 A.M. the abdomen had become distended, and early in the afternoon vomiting set in, at first gastric, then bilious, but never bloody or fæcal. The next morning, at 9.45, he passed a normal stool and died immediately afterwards, twenty-eight hours after the injury. At the post mortem, the intestines were found covered with a fibrinous exudation, on removal of which the vessels were seen to be much injected. Just to the left of the spine the small intestine was ruptured about the middle of the jejunum. The rupture was transverse, and involved the whole of its circumference, with the exception of about one-eighth of an inch at the attachment of the mesentery.

---

<sup>1</sup> *Brit. Med. Journ.* 1893, vol. i. p. 401.

The bowel itself was crushed only for a distance of about a quarter of an inch on each side of the rent, the edges of which were thickened and œdematous. (White, 'Brit. Med. Journ.' 1894, vol. i. p. 1077.)

**Prognosis.**—With but very few exceptions a ruptured bowel which is left unoperated upon leads sooner or later to a fatal result. Out of Poland's thirty-eight cases, twenty-six died within forty-eight hours. Injuries to the jejunum do not seem more rapidly fatal than those to the ileum. The remote possibilities of a natural cure depend either upon adhesions forming between the rupture and some neighbouring part, or the formation of a localised abscess, which, bursting externally, produces a faecal fistula. In cases operated upon, the chances of success largely depend upon the time which has elapsed between the injury and the operation. Where this is short, and before the progress to any marked extent of general peritonitis, a reasonable hope of recovery may be entertained. In 1890 Croft estimated that recoveries after operation were one in fourteen. In 1894 Battle<sup>1</sup> was able to record that since Croft's statistics were published in 1890, he had collected fifteen cases with seven recoveries. Shock after the operation, and peritonitis, are the two most cogent factors in causing death. The prevention of these therefore must be the surgeon's chief aim if success is to be looked for.

**Treatment.**—Recognising the almost uniformly fatal termination of these cases when left to the unaided efforts of nature, exploratory laparotomy should be performed as soon as the patient has sufficiently recovered from the primary shock.

During the early period the patient should be kept at rest in bed, warmth applied to the body generally, and hot fomentation to the surface of the abdomen. If stimulants are deemed necessary, brandy should be given by the rectum, or ether by subcutaneous injection. Nothing should be administered by the mouth.

In performing the operation, the abdominal incision should be made in the median line above the umbilicus. This admits of examination of the stomach and duodenum, as well as of the upper part of the jejunum. If necessary for

<sup>1</sup> *Brit. Med. Journ.* 1894, vol. i. p. 963.

a more complete examination or for easier and more efficient treatment of the rupture, the incision may be enlarged downwards or laterally.

On opening the peritoneal cavity, the escape of gas or faecal matter will confirm the diagnosis. A systematic and careful search for the rupture should then be made. A loop of intestine being withdrawn from the abdominal cavity and held by an assistant, one end is traced until it leads to its fixed extremity, which may either prove to be the duodenal above or the caecal below. This portion of the bowel, as it is drawn out through the parietal wound, should be carefully protected by the assistant with warm sponges or cloths, and as soon as its examination is completed it should be carefully replaced before a similar process is gone through with the other end of the loop.

When the rupture has been found, the surgeon has to decide what method he will adopt in treating it, whether he will elect to (1) stitch it up, (2) to resect it, or (3) to attach it to the parietal wound and so form a faecal fistula or an artificial anus.

(1) Stitching up the wound should only be adopted when the rupture is small or of the nature of an incision with non-contused edges. A series of interrupted Lembert sutures should be inserted. The true guidance for the employment of this method is when the application of sutures can be effected without seriously narrowing the calibre of the canal. A successful case by this method is recorded by Williamson.<sup>1</sup> The operation was performed thirty hours after the accident. The rupture was found at the junction of the jejunum and the duodenum.

(2) Excision, with reunion of the divided extremities, or some form of lateral anastomosis, must be considered when the simple method above described cannot be carried out. In other words, it should be adopted when the wound is large, or its edges so contused that sloughing or gangrene is probable. By this method of enterectomy and circular suture Wiggin<sup>2</sup> succeeded in treating a case of ruptured ileum. Although the rupture was very small, the contusion of the wall

<sup>1</sup> *Brit. Med. Journ.* 1895, vol. i. p. 200.

<sup>2</sup> *New York Med. Journ.* 1894, vol. lix. p. 68.

around the rupture was so severe and extensive that it was deemed advisable to excise six inches. In the second of Croft's two successful cases<sup>1</sup> this method of treating the rupture was adopted.

(3) The formation of an artificial anus is the wiser course to adopt when portions of the bowel distal to and distant from the seat of rupture are sufficiently badly contused to render it advisable to give the parts complete rest. The temporary diversion of the fæces through the artificial aperture gives greater chance of repair to the contused parts, and lessens therefore the risk of subsequent perforation. In the first of Croft's cases this course was adopted.

The finding of a single rupture should not satisfy the surgeon that that is the sole lesion present; the possibility of a second elsewhere must be remembered, and also the existence of badly contused areas. Further, the mesentery and omentum should always be carefully looked to; especially should this be done when there is evidence of intra-abdominal hæmorrhage. It is usually from some torn vessel either in the mesentery or omentum that bleeding most freely takes place. In addition to the injury to the bowel and its attachments, it is necessary to remember the possibility of grave lesions of the neighbouring viscera.

When the rupture or any other lesion has been dealt with, the peritoneal cavity must be thoroughly cleansed either by swabbing or by washing out. This needs to be all the more efficiently done if peritonitis has commenced or fæcal extravasation has been marked. In these latter cases the abdominal cavity should be drained. As accumulations of fæcal or inflammatory material are more liable to take place in the pelvis, the tube should lead well down into that cavity; and where this cannot be effectually done from the wound above the umbilicus, a second incision should be carried through the parietes below it.

It has happened that while there has been distinct evidence of rupture, from the extravasation of foreign material into the abdominal cavity, the lesion could not be found. Such was the case in a patient treated successfully by Parker.<sup>2</sup>

<sup>1</sup> *Trans. Clin. Soc. Lond.* 1890, vol. xxiii. p. 141.

<sup>2</sup> *Annals of Surgery*, 1893, vol. xvii. p. 590.

The peritoneal cavity was freely irrigated and then carefully packed with gauze. Each piece, one yard long by sixteen inches wide—of which six were used—was placed between the folds of the intestine, which were lifted up out of the pelvic cavity, this latter being filled with gauze. The following day an anæsthetic was administered, the gauze removed, and the cavity re-stuffed. This was repeated some three or four times, when the parts began to contract and soon completely closed.

The treatment after operation for rupture is that carried out in all similar instances of intra-abdominal operation, rest and rectal alimentation being the primary requisites.

---

## CHAPTER XXXVII

### INJURIES (*continued*). PUNCTURED AND INCISED WOUNDS

WHILE wounds of this nature are usually severer in their effects upon the jejunum and the ileum than upon the large bowel, the difference in other respects is hardly sufficient to necessitate a separate discussion of each region. It is proposed therefore to treat them together, noting such points of distinction in the pathology, symptoms, and treatment of each as may seem necessary.

From a purely clinical aspect, punctured or incised wounds of the bowel practically resolve themselves into what is more broadly comprised in similar wounds of the abdomen. A patient who has received a punctured wound in this region, may present symptoms which in no way indicate whether (1) the parietes have only been incompletely penetrated or whether (2) there has been complete perforation, or whether (3) such perforation has injured the bowel only slightly or (4) severely.

It has been a fruitful source of discussion in more recent times to determine what attitude the surgeon should adopt in those cases where the symptoms are not sufficient to indicate the true nature and extent of the lesion. This is a matter, however, which will be dealt with when considering the question of treatment.

**Nature of lesion produced.**—1. *The injury to the parietes.*—The shape and extent of the wound in the abdominal wall will depend upon the nature of the agent causing the injury, the force with which it acted, and the direction and distance from which it came ; or, in the case of stationary objects, the distance from which the individual had fallen. In but few cases is there liable to be much gaping of the parts, and therefore without the hernial protrusion of the bowel or the escape of its contents, it may often prove difficult, if not impossible, to decide from external appearances whether or not the wall has been completely perforated.

We have, however, here to deal only with actual instances of complete perforation. A deliberate stab with a knife may produce an incision no longer than the breadth of the blade ; but if this be plunged in or withdrawn obliquely, a much larger wound would be produced. The lesion caused by a small, round, sharp-pointed body, such for instance as a stiletto, does not as a rule inflict an injury of any magnitude ; indeed the contraction of the strong abdominal muscles around the narrow channel of penetration reduces it to such an extent that these frequently prove the most deceptive cases.

The nature of the agent, and the circumstances under which it existed or was used, should be well considered in framing any opinion as to the possible extent of the lesion, however opposed in other respects might be the suggestions conveyed by the external appearances of the wound. Blunt-pointed bodies, such as spikes of palings, stakes, &c., which pierce the abdomen in cases of falls from a height, produce lacerated and contused perforations.

2. *Injuries to the bowel.*—Whatever the nature of the agent inflicting the injury, the extent of the lesion will be considerably affected by the state of the bowel at the time. If distended, it is more likely to be gravely involved than in the opposite condition.

The bowel, like the parietes, may be incised, punctured or more or less torn according to the nature of the agent producing the wound. In the case of incised wounds, the resulting aperture varies according to the direction of the incision ; when this is longitudinal or parallel to the axis of the bowel, a larger opening will probably take place than if



the cut has been a transverse one. The circular muscle of the intestinal coat appears to have a more powerful effect in causing the wound to gape than the longitudinal. There is therefore a greater liability of escape of the bowel contents in the one case than in the other. In small punctured wounds, the contraction of the surrounding muscle fibres may almost obliterate the aperture. In many instances there is prolapse of the lax mucous membrane, so that it forms a hernial protrusion through the aperture, the result of which is to establish a fistulous communication with the general peritoneal cavity. Multiple lesions are always possible; either the same part may be transfixed, presenting therefore two opposite orifices, or two or more independent coils may be similarly injured.

The escape of fæcal material is more liable to happen in wounds of the small than of the large intestine, because of the more liquid condition of the contents of the former. Leakage will naturally be more probable in cases of a full than of an empty bowel.

**Symptoms.**—As already indicated, the difficulties connected with determining whether in any given case the bowel has been injured are often very great. It might almost with truth be said that unless gas or fæcal material exudes from the abdominal wound or from a prolapsed portion of bowel, there are no other symptoms at the time of the injury, or very shortly after it, which would lead to the certain diagnosis of injured intestine.

Shock is most variable, indicating on the one hand, as it may, a purely emotional effect where no gross lesion exists, and on the other an injury so severe that a fatal result must almost inevitably accrue. Where shock is not sufficient to mask other symptoms, the immediate result of the injury may be to cause acute abdominal pain, followed by vomiting and possibly some movement of the bowels. Blood may be passed *per rectum*, but this, when it occurs, is usually some little time after. One of the most reliable symptoms, and one which by some is considered almost pathognomonic, is tympanites. Its presence therefore at an early period should excite the gravest fears that the bowel has been opened.

When later symptoms arise, they will usually be those

indicative of peritonitis, arising, if not directly from the traumatism, indirectly from the extravasation or escape of faecal material into the peritoneal cavity. In some instances the symptoms at the outset are so slight that it is reasonably doubted whether any grave lesion can have been inflicted, yet in the course of a few days the patient is suddenly struck down with what soon proves to be acute general peritonitis. The explanation of this is the giving way of certain adhesions which, for the short time being, had been sufficient to prevent leakage at an earlier period.

In cases of much loss of blood, the increasing pallor of the face and the weak, compressible pulse soon indicate the nature of the injury. Either blood has escaped or is escaping from the wounded surface of the bowel, or it is coming from a severed mesenteric vessel. When the quantity of blood lost is large, it is more commonly from the latter source.

**Prognosis.**—With often so little definite knowledge gained from the symptoms as to what is the true nature of the lesion, an opinion at the outset regarding the future issue of any case becomes impossible. If, however, we reason on certain definite assumptions, we can then frame a prognosis; for ample experience is forthcoming to show what is liable to happen in any case where no surgical measures are adopted.

In the first place, then, if faeces or gas escape from the parietal wound, one of two things must happen: either the patient will shortly die of peritonitis, or adhesions will form between the visceral and parietal apertures, and a faecal fistula result. The probabilities are all in favour of the former.

Where, again, the bowel has been opened in a distended condition, extravasation will almost certainly occur, resulting in fatal peritonitis. On the other hand, incision or puncture of collapsed intestine may result in the rapid formation of adhesions which, in thus occluding the orifice, will effectually form a barrier to the escape of foreign material. An injury to the large bowel in a collapsed condition is still more likely not to be followed by any leakage than in the case of the small.

It need hardly be pointed out that the nature of the agent producing the injury must largely affect the prognosis; for

the larger the wound inflicted, the greater the probability that untoward conditions must arise. However slight therefore the symptoms at the time of the injury, a graver prognosis needs to be formed where the agent has been a sword or a broad-bladed knife than where it has been of the nature of a small, narrow, sharp-pointed body.

There is much to show that operation performed before the onset of peritonitis may prove successful. Stimson's case, narrated below, illustrates the good result following laparotomy; Puzey<sup>1</sup> also records a case of multiple stab wounds of the small intestine. Some of the wounds were closed by the Czerny-Lembert suture; but owing to the damage done to a part of the mesentery and the portion of the bowel to which it was connected, about ten inches of the intestine had to be removed. The divided ends were united by a Murphy's button. The patient made a good recovery.

**Treatment.**—Enough has been said in discussing the symptoms and prognosis of these wounds to show how difficult must be the question of treatment. To know that nature is capable of executing repair and not to know in what particular instances she can do so, sums up the sole difficulty in which the surgeon finds himself. It would be comparatively easy to say what should be the treatment if the lesion was precisely known. But in the large majority of instances we know at the outset little more than that the abdominal wall has been either partially or completely penetrated. Discussing therefore the treatment from the clinical standpoint, the first question which always presents itself is, are we to stand by and wait to see what nature will do, acting, for the time being, on the broad principles of rest; or are we to probe the matter to the bottom, and satisfy ourselves what is the nature of the lesion, if such there be? To have suggested, much less to have adopted, the latter course some years ago, would have been deemed meddling, if not actually bad, surgery. But is this likely to be the opinion of modern surgeons? I cannot venture, on the basis of my own limited experience of these cases, to offer any opinion; but if the practice and teaching of those surgeons whose experiences have been amply sufficient to warrant the foundation of a definite practice may

<sup>1</sup> *Brit. Med. Journ.* 1896, vol. i. p. 1036.

be accepted, then it would appear that the right course to adopt is not to leave the issue to the vague and uncertain possibilities of nature, but to actively interfere.

It may then be considered that the proper practice to adopt, in all cases of perforating abdominal wound, is to probe the wound, ascertain its direction and extent, and, if found to perforate the parietes, to proceed at once to open the abdomen and explore its contents. Where there is any difficulty in passing the probe, as there may be from the contraction of the abdominal muscles producing some deviation of the original track, McBurney's suggestion should be carried out. The wound should be opened up, beginning with the superficial tissues, and then the walls split, layer by layer, until it is rendered certain that complete perforation has taken place.

What treatment the bowel should receive will naturally depend upon the nature and extent of the lesion. A simple incision of limited extent, or a perforating wound, will need little more than careful stitching with Lembert sutures. Complete section of the canal must be treated by circular suture, or by one of the numerous methods now in use for intestinal anastomosis. It may be considered proper to stitch the bowel to the parietal wound, and so form for the time being a fæcal fistula or an artificial anus, which can be subsequently dealt with. A careful investigation of the whole length of the canal should always be made, as multiple lesions are not infrequent. As soon as the surgeon has satisfied himself that all lesions have been efficiently dealt with, whether they are only of the bowel or of the mesentery also, the peritoneal cavity should be thoroughly irrigated with warm water. This should be all the more radically carried out when there has been distinct evidence of extravasation ; or, without such evidence, when the wound in the bowel has been sufficiently large to render it probable that some leakage has taken place.

CASE LXIII.—*Stab wound of the abdomen, with multiple wounds of the intestine: laparotomy: suture. Recovery.*

A man aged 18 was stabbed in the abdomen with the large blade of a penknife. The wound was a little below and to the right of the umbilicus, and was about half an inch in length. The patient seemed comfortable, made no complaint, showed no signs of collapse, and the wound seemed to have been limited to the abdominal parietes. The pulse, how-

ever, was small and wiry, so that it was considered wise to explore the wound. An anæsthetic was administered, when it was found that the parietes had been completely perforated. The abdominal cavity was then opened and found to contain more than a quart of free blood. An examination of the bowel revealed three incised wounds of the small intestine, each about a third of an inch in length. Two wounds were also found in the omentum, and one in the mesentery; that in the latter appeared to have been the source of the hæmorrhage. The wounds were closed by a single row of silk Lembert sutures. The patient made an excellent recovery. (Stimson, 'Annals of Surgery,' 1894, vol. xix. p. 89.)

---

## CHAPTER XXXVIII

### INJURIES (*continued*). GUN- AND PISTOL-SHOT WOUNDS

WOUNDS of this kind fall more within the domain of military than civil surgeons, but they are sufficiently frequent in the practice of the latter to warrant, if not a detailed description of the symptoms and lesions, at least a careful consideration of the question of treatment. In civil practice the wounds met with are mostly those inflicted with revolvers and fowling pieces; in the former case the weapon is used, as a rule, at close quarters and with homicidal intent; while in the latter the wound is mostly the result of accident, and varies in severity according to the range.

**Symptoms.**—Quite as much difficulty exists in determining the nature of a pistol- or gunshot wound as in the case of incised wounds. Not only does shock form a most variable concomitant, but the gravity of the lesion itself may bear no ratio to the more strictly local signs. In the majority of instances, however, there will be both local and constitutional evidences of perforation; and it must be taken as exceptional where one or two signs at least do not stand out prominently.

Tremaine,<sup>1</sup> as the result of a somewhat extensive experience in wounds of this class, in both military and civil practice, states that he has been led to the following conclusions: 'That the calibre of the ball, the proximity of the weapon, and the position of the wounds of entrance and exit have an important bearing. That, as regards general symptoms, the existence

<sup>1</sup> *Philadelphia Medical News*, 1886, vol. xlix. p. 601.

of prolonged shock, a lowered temperature, a feeble pulse, great restlessness, marked anxiety of countenance, accompanied by tympanites and great pain, taken in connection with the anatomical location of the wound, afford very strong evidence of a perforating wound of the intestines. That the escape of blood from the anus rarely happens soon after the injury, and is consequently of little value as a diagnostic sign.'

As exceptional instances, where either the severity or the mildness of the symptoms is liable to mislead, may be mentioned first the case, already quoted, where the patient was apparently moribund from severe shock, although there was no perforation; and, second, a case reported by Gerster,<sup>1</sup> where there were several perforations but no serious symptoms. In the former case the bullet had only perforated the clothes in which it was found, the skin being quite intact; in the latter it had perforated the small intestine in two places, and the large in one. The case was that of a boy who when admitted into hospital showed no signs of shock, internal hæmorrhage, or escape of fæces, yet when the abdomen was opened about six hours afterwards, the above wounds in the bowel were found with extravasation of fæces into the abdominal cavity, and commencing peritonitis.

**Nature of the lesion.**—It may be roughly said that the lesion produced by shot or balls of different calibre vary only in the size of the aperture; in all respects it is a lacerated wound, with a certain amount of destruction of tissue along the track taken by the projectile. The size of the aperture, however, creates a serious difference; for while a small one may become completely occluded by the contraction of the muscles surrounding the channel, a large one will, as regards both parietes and bowel, admit of the escape of fæces.

In the recent war between Japan and China, the Japanese were provided with two kinds of rifles, one of which fired a bullet encased in a hard jacket composed of copper and nickel, in diameter 0·315 inch, in weight 238 grains, and with an initial velocity of 1,850 feet per second; and the other a bullet entirely composed of lead, 0·45 inch in diameter, 420 grains in weight, and having a velocity not much more than half

<sup>1</sup> *Annals of Surgery*, 1894, vol. xix. p. 91.

that of the other. Christie,<sup>1</sup> in a letter to the 'British Medical Journal,' contrasts the effects produced by each kind. In the former, where the bullet is smaller and travels at greater velocity, the soft parts of the body are cleanly perforated, there is neither contusion nor laceration; while the opposite conditions are observed in wounds produced by the larger, softer, and less rapidly travelling bullets.

The course of the bullet in the abdominal wall is often difficult to trace. It may have completely perforated the parietes, and a dark-stained aperture of entrance may be seen, but the passage of a probe along the track may be quite impossible. This difficulty may arise from one of two causes—either the unequal contraction of the powerful parietal muscles so

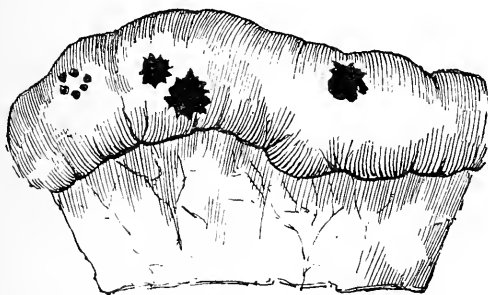

FIG. 45.—PISTOL-SHOT WOUND OF SMALL INTESTINE. (Bull)

alters the direct continuity of the canal that it is practically rendered impermeable, or, from a want of knowledge as to the course taken by the bullet, the surgeon fails to strike the track. The point is of considerable practical importance to remember, because the failure in any endeavour to pass an instrument along the track of the ball should not mislead the surgeon into the belief that no perforation has taken place. In Gerster's case, above quoted, it was not possible to pass a probe along the track in the abdominal wall, and yet, as noted, there were three intestinal perforations.

To what extent a ball may be deflected by the soft parts through which it passes, it is not possible to say. It is held by many that such deflection does take place, while, on the

<sup>1</sup> *Brit. Med. Journ.* 1895, vol. i. p. 822.

other hand, McGraw,<sup>1</sup> as the result of numerous experiments on dogs and sheep, maintains that the track is always a perfectly straight one. However this may be, one fact appears certain, that the coil of bowel most injured is that lying immediately behind or opposite the track in the abdominal parietes.

As a means of diagnosing the existence of perforation in the bowel, Senn has suggested inflation of the intestine with hydrogen gas. The escape of gas through the wound after opening the abdomen necessarily indicates that the bowel has been perforated. By many, however, this method of diagnosis is considered, if not impracticable, at least frequently objectionable. The tension of the bowel tends to open an aperture which nature may have already efficiently sealed; and thus where the abdominal cavity has been free from septic contamination, the escape of faecal matter through the dilated orifice will add a source of danger which otherwise would not have existed. On the other hand, it can be argued that the escape of gas renders it impossible to overlook an aperture which without such a method of diagnosis might not have been detected.

**Prognosis.**—It may always be said that the smaller the projectile the more favourable will be the prognosis; hence a wound produced by pellets will be comparatively less serious than one produced by a pistol ball. A charge of shot fired at close quarters will produce a much graver injury than after the charge has spread.

In cases where no operation is performed, by far the larger number end fatally from acute general peritonitis. Such cases as recover for a short time or completely, do so from the formation of adhesions. These may serve to occlude the lacerated orifices until the slough separates and is carried away with the faeces, or they may form the boundaries of a localised peritonitis which ends in the production of an abscess. In the latter case the abscess may burst into the bowel, the most favourable course; or externally, with the possible sequel of a faecal fistula; or into the peritoneal cavity, with the fatal result of acute suppurative peritonitis.

In cases which have been operated upon, that is to say, in which laparotomy has been performed, the chance of a

<sup>1</sup> *Trans. Amer. Surg. Assoc.* 1889, vol. vii. p. 123.



successful result much depends upon the time which has elapsed between the receipt of the injury and the operation. If performed within six hours, the prospects are much more favourable than at any time after that; for in cases of extravasation, peritonitis will have commenced, and this always adds a serious factor to the existing lesion.

Statistics do not afford any very safe means for determining the value of operation; for, as seen, so much depends upon the size of the projectile, the range at which it was fired, and the period of time elapsing before operation. Numerous cases of recovery are recorded where it appears certain that but for the operation a fatal result must have ensued.

Scott<sup>1</sup> records a case of four perforations in the ileum which were successfully closed by the Czerny-Lembert suture, the patient making a good recovery. Bull<sup>2</sup> operated with success on a case in which there were seven perforations which were sutured; the operation was seventeen hours after the accident. Stimson<sup>3</sup> successfully sutured two perforations in the sigmoid flexure, the patient making an uninterrupted recovery. Miles<sup>4</sup> gives twelve cases of laparotomy with four recoveries; of these latter, one had 16 wounds of the small intestine, one 14, another 10, and the remaining one 3. Carmalt was successful in a case where there were five wounds of the intestine and mesentery (see Case LXV.). Roberts<sup>5</sup> operated in a case four hours after the receipt of injury. There existed eight perforations in the bowel and three in the mesentery. The wounds were closed, and the patient made a good recovery. Woolsey<sup>6</sup> records a case of sixteen perforations of the intestines produced by a pistol of .32 or .38 calibre. All the perforations were in the small bowel, most in the lower ileum, and, with the exception of four, were closed with a continuous Lembert suture of fine silk. Four of the perforations were so close together that separate suture would have resulted in stenosis; hence three inches of the

<sup>1</sup> *New York Medical Record*, 1890, vol. xxxviii. p. 516.

<sup>2</sup> *New York Med. Journ.* 1885, vol. xli. p. 185.

<sup>3</sup> *Annals of Surgery*, 1894, vol. xix. p. 90.

<sup>4</sup> *Trans. Amer. Surg. Assoc.* 1893, vol. xi. p. 349.

<sup>5</sup> *Lancet*, 1894, vol. ii. p. 1160.

<sup>6</sup> *Annals of Surgery*, 1896, vol. xxiii. p. 423.

bowel was excised, and the divided ends united by a Murphy's button. There was some extravasation of fæcal matter and commencing peritonitis. The abdominal cavity was flushed out with large quantities of sterile normal salt solution. The patient, whose age was 23, made a good recovery, which the author largely attributed to the fortunate circumstance that he had eaten nothing for twenty-four hours previous to being shot. Tiffany<sup>1</sup> succeeded, by suture, in a case where there were found at the operation eight perforations of the small intestine and four wounds of the mesentery.

As regards the ultimate lodgment of the bullet, if it does not pass right through the body, as it rarely does, it may find a final resting place in the soft parts of the parietes opposite the seat of entrance; or, if it becomes spent before completely traversing the abdominal cavity, it may simply pass into the bowel or fall into some dependent part of the peritoneal cavity.

It must be remembered that balls, especially the larger ones, are liable to carry into their track particles of clothing which, from their naturally septic character, are likely to produce inflammation independent of any due to the perforating lesion.

**Treatment.**—No class of cases has given rise to more discussion in recent years regarding the question of treatment than that under consideration, and the points at issue may be briefly summed up in the simple question of whether laparotomy should or should not be performed, or, in other words, whether the patient should be left to the unaided efforts of nature or whether the surgeon should intervene.

From the conflicting opinions held some few years ago, it would have been impossible to deduce a method of practice which had sufficient weight to enforce it as the only correct one to adopt. If we go far enough back we find a distinct feeling in favour of non-interference. But in the most recently expressed views there is a clear and decided leaning towards active intervention. The success which has attended operations in cases where death was otherwise inevitable, as well as the now incontestable safety of carefully and properly

<sup>1</sup> *American Journal of the Medical Sciences*, 1896, vol. cxi. p. 551.

performed laparotomy, have largely tended to clear the way for a definite line of treatment. If a bowel has been badly perforated, operation alone can save life ; if on the other hand the perforation has been small and capable of natural repair, a carefully performed laparotomy should neither hinder the reparative process nor cause any additional danger.

Assuming therefore that laparotomy is a perfectly proper operation to employ, are there any special indications against its adoption in any particular case ?

As has already been pointed out, the diagnostic value of probing a wound is practically small, for in a case of complete perforation it may be impossible to pass a director along the track of the bullet.

If, then, there is distinct evidence of a wound of entrance, that may, for all practical purposes, be deemed sufficient reason for entering upon other considerations regarding the question of laparotomy. The most important of these is the size of the ball. If known to be large, the question is settled, and the sooner the operation is performed the better. The only reason for delay is shock, which must first be allowed to pass off somewhat before the shock associated with every operation is added. An endeavour, however, must be made to operate before general peritonitis has set in. Approximately it may be said that this serious complication commences, as a rule, within the first six hours.

Wounds produced by pellets of small shot, and especially when the symptoms at the outset are very slight, do offer, at the first sight, considerable temptation to delay operative interference. Experience, however, teaches that death is the most common result in these cases, and hence laparotomy should not be delayed. The only instances where there would seem to be reason for non-interference are those cases, seen for the first time some twelve to twenty-four hours after the accident, in which the patient appears free from any serious symptoms. Here it is possible that nature is effecting repair, and that no extravasation has taken place into the peritoneal cavity. To operate under such circumstances would only possibly impede or deleteriously interfere with the reparative process.

*The operation.*—If it is right to speak of more care in

performing laparotomy for one cause than for another, then such additional care should be exercised in the treatment of shot wounds of the intestine ; for this reason, that it is always necessary to handle and examine the whole length of the intestinal canal. Hence every precaution as regards warmth and cleanliness must be adopted to protect the bowels during the necessary exposure and manipulation to which they are subjected.

A median incision below the umbilicus is the one usually selected, as affording a better opportunity of both examining the abdominal contents and treating the wounds found.

As in the case of incised wounds, the escape of gas or fæces on opening the abdomen will definitely indicate the existence of perforation.

A loop of bowel is picked up, and one end carefully traced until a perforation is met with. After this is closed the search is continued. If the bowel is not returned into the abdomen as the examination proceeds, it should be carefully protected till the end of the portion under investigation is reached, when it should be replaced before the other portion is commenced.

As regards the treatment of the bowel lesion, all depends upon the nature and extent of the injury. The simplest and best method, when it can be done, is to close the aperture by a few Lembert sutures ; theouting mucous membrane should be turned in and the opposing serous surfaces united. If any portion of the bowel is so badly damaged, either from the size of a single aperture or the proximity of several wounds, so that simple union does not appear possible, removal of the part will be necessary.

The condition of the mesentery should be carefully noted as the examination of the bowel proceeds ; this is the more necessary when there is evidence of considerable hæmorrhage. No doubtful bleeding point or lesion in the mesentery should be left unsecured.

After both small and large intestine have been completely and carefully overhauled and all lesions treated, the abdominal cavity must be freely and efficiently irrigated, with the insertion of a drainage tube if considered advisable.

As regards after treatment, everything must be carried out on the general principle of rest, sufficiently discussed in detail already under other operations upon the intestinal canal. (See page 216.)

There are various points—such for instance as the shape of a ball, whether round or conical &c.—which have a bearing upon the nature of the lesion produced, which are unnoticed here. Upon these and many others, works on military surgery must be consulted. The reader, however, may profitably refer to an exhaustive and very instructive discussion on gunshot wounds in civil practice which took place before the American Surgical Association.<sup>1</sup> Points are touched upon there which a limited space has prevented from introduction here.

CASE LXIV.—*Pistol-shot wound of the small intestine: seven perforations: laparotomy: suture. Recovery.*

W. M., aged 22 years, admitted into hospital with a pistol-shot wound of the abdomen. When seen half an hour after the accident, he was perfectly conscious, warm, with a pulse of 96, of good volume; temperature 97·8° F.; respiration 18. He had vomited solid food. He retched frequently, complained of great pain all over the abdomen, and had tenesmus. The abdomen was tender, but not swollen or tympanitic. The wound of entrance was situated an inch and a half below the navel, and an inch and a half to the left of the median line. It was half an inch in diameter, with blackened edges. The bullet could not be detected anywhere beneath the skin. The wound was not probed. Seventeen hours after the accident laparotomy was performed. On opening the peritoneal cavity, bloody serum without any faecal masses, but containing small clots, flowed out freely. Several coils of intestine, representing three or four feet in length, were then pulled out of the wound and carefully examined. The intestine and mesentery were coated here and there with clots and flakes of fibrin. The bowel, as it was withdrawn, was placed under layers of towels and occasionally drenched with warm water. The first wound was about half an inch in diameter, situated midway between the attached and the free border of the intestine and several feet from the cæcum. The serous coat was clean cut, the mucous membrane lacerated and everted. Six other wounds were found, and in each instance the everted mucous membrane acted as a plug. All the wounds were closed with Lembert sutures. The patient made a good recovery. (Bull, 'New York Med. Journ.' 1885, vol. xli. p. 185.)

---

<sup>1</sup> See *Trans.* 1889, vol. vii. p. 123.

CASE LXV.—*Revolver-shot wound of the intestine and mesentery : five perforations : suture. Recovery.*

The patient was a lad between 12 and 13 years of age, who had accidentally shot himself, at about 11 A.M., with a .22-calibre revolver held in immediate proximity to the abdomen. When seen, there was no pain in his abdomen, and the only soreness he would acknowledge was directly at the point of entrance of the bullet, which was about half an inch to the left of and a little above the umbilicus. The wound was about a quarter of an inch in diameter, with discoloured edges; and his trousers and shirt (the only garments he wore) had perforations in them corresponding to the situation of the wound.

The wound was explored and found to go nearly perpendicular to, but slightly downward and outward, and evidently entirely through, the abdominal wall. An incision was carried along the track of the wound, and continued to and then along the median line. No blood appeared in the abdominal cavity, and at first no evidences of injury to the contained organs; but on drawing the intestines out, protecting them at the same time by keeping them wrapped in moist, warm aseptic towels, and passing them gently and rapidly through the fingers in search for an injury, a double perforation in the upper part of the small intestine was revealed. These perforations were evidently the points of entrance and exit respectively of the bullet, and were separated by about half an inch of sound tissue. These were sewed up as one wound, using very fine silk, by the Lembert suture. Continuing the search, two other very similar wounds were found in the large intestine which were treated in the same way, and later a single perforation in the mesentery, directly at its junction with the intestine. In all, five separate wounds were found. No escape of the contents of the intestine had occurred, and, as mentioned, there was no hæmorrhage; but the bullet and two small pieces of cloth were found. The intestines were replaced, the abdomen thoroughly flushed out with warm boiled water, and the external wound closed with silkworm-gut sutures.

He had eaten nothing that morning. He had drunk some milk about an hour before the accident, and was waiting for his dinner. This accounted for the empty condition of his stomach and his bowels and the absence of fæcal extravasation through the intestinal wounds. The bowels moved in the course of the first week. Five months after the operation he was in perfect health. (Carmalt, 'Annals of Surgery,' 1895, vol. xxi. p. 360.)

---

## CHAPTER XXXIX

### FOREIGN BODIES

It would involve far too extended a discussion of the subject to attempt to deal with all the foreign bodies which may pass into, pass through, or arise within the intestinal canal.

It is only proposed to consider certain of these, and more particularly to treat of the troubles to which, when impacted, they give rise. It may, *imprimis*, be broadly pointed out that there is hardly a body, which is able to pass through the œsophagus into the stomach, which will not pass unobstructed throughout the entire length of the intestinal canal. That a certain body becomes impacted in the gut is rather an accident than dependent upon any definite and constant cause. A body similar in all respects to one which has become obstructed and led to a fatal issue in one case, has in another passed harmlessly through the entire bowel. The weekly medical periodicals frequently contain the record of a patient who has successfully passed *per rectum* some body of extraordinary shape, size, or consistency. They are all of interest as showing what nature can do, and what the surgeon may reasonably hope for in any case where he knows that a certain object has been swallowed. What, however, we have principally to deal with here, is the mischief a body may set up if perchance it does not pass unchecked through the bowel; and what therefore the surgeon should be prepared for, if his favourable expectations are not realised; or what he should be in a position to recognise if no clear history is forthcoming to indicate the true cause of the symptoms.

It is proposed to embrace in the consideration of the subject both the small and the large intestine, for while there may be some slight differences, there are many more points of agreement. The lesions which may arise as the result of impaction in either portion of the bowel are much the same.

**Nature of foreign bodies.**—It need scarcely be pointed out that there is hardly any limit—except regarding size—in shape, consistency, and weight of the bodies which may become lodged in some part of the bowel. In the case of sane people, it is frequently some article of diet, such for instance as a fish bone, or other small bone either whole or in fragments, fruit stones, &c.; while in lunatics, and those who practise tricks of jugglery, they are knives, forks, spoons, tobacco pipes, broken pieces of china, glass, &c. In the former class of patients it more frequently happens that nothing is known of the fact that something has been swallowed likely to account for the symptoms which subsequently arise, except in such

instances as the accidental swallowing of a dental plate, a coin, a pin, and suchlike articles. In the latter class, however, some clue usually exists from the absence or loss of certain articles previously known to have existed, and the confession on the part of the individual.

There is a class of bodies within the intestine of natural formation which are sometimes the cause of serious troubles—namely, intestinal concretions or enteroliths, and biliary calculi. These will receive separate consideration later.

**Course of a foreign body in process of natural expulsion.**—The best guide to the symptoms connected with the lodgment or impaction of a foreign body is a knowledge of the processes which nature adopts for its expulsion.

While it is possible for the body to lodge and produce its ill effects in any part of the canal, from the duodenum to the sigmoid flexure, it more frequently happens in the neighbourhood of the cæcum. Here it may become impacted in the narrowed orifice of the ileo-cæcal valve, or lodged in the cæcum. Science has recently in a very remarkable way demonstrated the fact that foreign bodies do become lodged at these sites, and that such lodgment is capable of detection during life. Sidney Rowland<sup>1</sup> briefly describes a case where by means of the Röntgen X rays he was enabled to show that a halfpenny which a child of 6 years of age had swallowed some four months previously, and which had given rise to constant symptoms, was lodged at the ileo-cæcal valve. The skiagraph showed the halfpenny lying on the right iliac bone.

The following pathological events may occur where a foreign body becomes lodged at any particular part :

1. It causes ulceration of the bowel, which,
2. Without the previous formation of adhesions, may lead to perforation directly into the peritoneal cavity, but which,
3. With adhesion, may lead to a localised abscess.
4. The abscess bursting may create a communication with (a) the outside of the body, (b) the interior of some neighbouring viscus, or (c) the general peritoneal cavity.
5. It may cause temporary obstruction or
6. Acute intestinal obstruction.

<sup>1</sup> *Brit. Med. Journ.* 1896, vol. i. p. 807.



7. Certain bodies such as needles may pass innocuously through the tissues.

**Symptoms.**—With so many possibilities regarding the course which a foreign body may pursue, the symptoms which arise must be almost as numerous and distinctive. In most cases the course which each takes will have its own train of symptoms, as well as its own proper line of treatment.

1. *When the body causes ulceration.*—Whether or not symptoms manifest themselves in connection with ulceration of the bowel will depend mostly upon the amount of ulceration present. Even when small it may lead to enteritis, but when large and extending around the entire circumference of the bowel, it may be followed by stricture. The symptoms in connection with these conditions will be chiefly those of bowel irritation, as shown by diarrhœa, pains mostly of a colicky character, and other disorders connected with deranged intestinal action. As stricture advances and the canal becomes narrow, symptoms of obstruction may set in either gradually or more or less suddenly.

2. *Perforation of the bowel without adhesions.*—In all cases where previous thinning of the bowel has taken place by ulceration, or the immediate perforation of the intestinal wall has been of larger dimension than such as might be produced by the passage of a needle, the immediate result of the extrusion of the body into the general peritoneal cavity is to set up acute peritonitis. In these cases it not infrequently happens that the patient is enjoying perfect health, with no indication of any bowel trouble, up to the moment perforation takes place. Then follow acute pain, collapse, and later all the symptoms of peritonitis, from which the patient rapidly dies.

A very good example of such a sequel to the ejection of a foreign body is recorded by Nichols. It will be observed that there is little to distinguish the symptoms thus arising suddenly from such a cause, from those connected with perforations of the stomach or bowel from other pathological lesions.

CASE LXVI.—*Perforation of the bowel by a crown of a species of spear grass : acute peritonitis. Death.*

Lance-Corporal M., according to his own statement, was perfectly well until the morning of February 14, 1894. On that day, at 8 A.M., while at the ration stand, he suddenly felt ill, with great pain at the bottom of the belly. After completing his duty and lying down some time in the barrack room, he walked to hospital about a quarter of a mile, where he arrived at 11 A.M., appearing very ill. No cause could be discovered for his illness, which was diagnosed as peritonitis, and ended fatally two days afterwards. At the post mortem the intestines were covered with lymph, and there were several ounces of foul acrid matter in the peritoneal cavity. This was found to come from a minute hole in the gut, about a yard above the cæcum. The hole was the size of a No. 5 shot. One inch from it was seen a piece of grass sticking in the mucous membrane. It was the crown of a species of spear grass common in that part of the country. It had penetrated about half an inch between the mucous and muscle coats. There seemed little doubt that the hole which gave exit to the fæces and caused the acute peritonitis had been due to a similar piece which escaped observation. (Nichols, 'Brit. Med. Journ.' 1894, vol. i. p. 1242.)

3. *Perforation after the formation of adhesions.*—In any case of slowly progressive ulceration, as the result of the impacted body, it is more than likely that some inflammatory process will advance beyond the actual seat of ulceration; and as soon as this reaches and involves the peritoneal surface, adhesions usually take place between the affected part and some neighbouring tissue or organ. Any escape therefore of the body into the general peritoneal cavity is for the time being prevented. The body, however, gradually finds its way out, accompanied possibly with some of the septic contents of the bowel. It forms a bed for itself in the midst of the newly formed adhesions. Up to this stage there may have been no symptoms to indicate the process which was taking place within the abdomen. Any further advance, however, will soon become manifest. One direction in which this may take place is in the formation of an abscess, which, as it increases in size, may finally burst, either through the parietes externally, internally into some viscus, or into the general cavity of the peritoneum. The various symptoms therefore which may develop will depend upon which of these courses is taken.

4. *The abscess bursts (a) externally.*—That the abscess

is tending towards the surface of the body soon becomes manifest.

The first symptom will be the feeling of a tumour in the abdomen, somewhat tender on palpation. As the parietes and skin get involved, the evidence of inflammatory mischief becomes more prominent, until it is sufficiently clear that an abscess exists. With the exception of possibly some rise of temperature, these conditions may progress, especially in the earlier stages, with little or no constitutional disturbance. If the abscess is not opened it will burst, and then, if the body be not ejected, either continue to discharge through a fistulous opening or leave the more serious condition of a fæcal fistula. The latter condition depends upon the size of the ulcerated aperture in the bowel left after the passage through it of the foreign body. If on the other hand the body be removed while the communication with the bowel has already healed, a complete subsidence of all symptoms should follow.

The treatment of any case depends upon the stage to which the process has extended. Any attempt of the surgeon to deal with it at its earliest period, when little more than an ill-defined tender tumour can be felt within the abdomen, must be undertaken with care. Although the abscess may be localised it may not yet have contracted adhesions to the parietes, so that any endeavour to open it necessarily involves opening at the same time the general peritoneal cavity. If an exploratory operation is decided upon, the treatment of the abscess when opened will depend upon whether or not there is any material communication with the bowel. If there be no bowel communication, then after emptying the abscess cavity it should be dried and dusted with iodoform or stuffed with iodoform gauze. If on the other hand the serious complication of a fæcal fistula exists, the surgeon will have to choose between excision of the part, or attachment of the bowel to the parietes and the establishment of a fæcal fistula or an artificial anus. Whatever the difficulty encountered, cleansing of the peritoneal cavity must be efficiently carried out.

When there is distinct evidence of an abscess on the abdominal surface, there is little fear that adhesions have not formed with the parietes, and no danger exists therefore of

opening the peritoneal cavity. An incision is all that is needed, and if perchance a fæcal fistula remains, it can be subsequently dealt with by an intra-abdominal operation, supposing it does not naturally close.

It should be noted that the result of adhesions and the embedding of a foreign body within them does not necessarily lead to the formation of an abscess. In cases where foreign bodies remain for any length of time within the body cavity, it is by such a process of adhesive formation that they are cut off and kept secure for variable periods. At any time, however, inflammatory mischief may be set up and the sequence of events above described take place.

CASE LXVII.—*Perforation of the bowel by a fish bone : formation of intra-abdominal abscess : opened. Recovery.*

M. D., aged 34 years, was admitted into the Victoria Infirmary, Glasgow, on June 1, 1894. His complaint was that for two weeks previously he had suffered from pain in the right inguinal region. On examination of the abdomen a rounded tumour could be felt in the right inguinal region, on a level with the anterior superior spine of the ilium, and about two and three-quarter inches to the right of the middle line. It was tender on pressure, of firm consistence, and its limits could be palpated. The skin was freely movable over it. The patient was in a medical ward for five weeks before transference to a surgical ward. During that period his temperature had fluctuated between 97° and 99° F. His bowels had never troubled him, except that there was a slight tendency to looseness. The tumour had increased in size, until on July 3, the morning of the operation, it presented a well-marked projection of the parietes, with some redness of the skin, excessive tenderness, and a sense of fluctuation. An incision was made over the swelling, when pus escaped; and in digital examination of the cavity, a fish bone was accidentally discovered lying loose within it. The patient made a good recovery. (A. Ernest Maylard, 'Trans. Path. and Clin. Soc. Glasgow,' 1895, vol. v. p. 197.)

(b) *The abscess bursts into some viscus.*—This termination of nature's endeavour to get rid of a foreign body is rare; and from recorded cases it would seem that the bladder is the viscus most frequently perforated. It is usually not until the body has ulcerated its way through, or an abscess has burst with ejection of the body into, the bladder that symptoms of any urgency arise, and then those that do appear are solely connected with that organ. The patient soon complains of irritability of the bladder; there is frequency of micturition

associated with pain. The urine may contain particles of faecal material and pus, and when passed be accompanied by gas. The passage of a sound may or may not detect the presence of the body. The presence of gas and faecal matter will at once suggest a fistulous communication with the bowel, although the true cause of the connection may not be so easy to determine. Bodies which pass into the bladder from the bowel may be naturally expelled *per urethram*; failing such a result, they will need to be removed either by perineal or suprapubic cystotomy. In cases where a fistula exists between the bowel and the bladder, it may be considered necessary to perform an abdominal operation to close the two apertures. This, however, should not be attempted until nature has been given a fair trial to effect occlusion, for, as will be seen by the case below, the patient made a complete recovery without operation.

CASE LXVIII.—*Passage of a portion of a rabbit's femur into the bladder: expulsion per urethram. Recovery.*

The patient, a man, when first seen in April 1882 was suffering from a tumour in the lower part of the abdomen. Intestinal irritation had existed for some months, and the bladder also had been very irritable. The urine contained pus. The act of micturition terminated in a 'fizzing' sound, from the escape of gas along with the urine. No stone could be detected by the sound. A microscopical examination of the urine revealed pus and various kinds of bacteria. In June the patient was better, but by this time the urine was discovered to contain distinct faecal material. In passing his urine on one occasion, he thought a stone had come away. On examination of the substance it proved to be the expanded end of a rabbit's femur. After this, air and faeces still continued to pass, but gradual improvement took place, and finally complete recovery. (Harrison, 'Medical Press and Circular,' 1883, vol. ii. p. 441.)

Harrison also refers to two other cases. In one a hair-pin, and in the other a slate pencil had passed from the bowel into the bladder. In both instances the bodies were removed by operation.

(c) *The abscess bursts into the peritoneal cavity.*—This rarely happens as a natural result. The tendency rather is for adhesions to form with other parts and so protect the peritoneal cavity. The cause most likely to bring about such an untoward result is some undue and sudden exertion on the part of the patient, who, ignorant—from the absence of

previous symptoms—of any internal trouble, is suddenly seized with acute abdominal pain. To the surgeon nothing is suggested beyond the fact that possibly perforation has taken place. The only treatment therefore of any value is exploratory laparotomy. The discovery of a foreign body or faecal material within the abdominal cavity should lead to a close and careful search for any perforation in the bowel. The further treatment of the case will depend upon the state of the parts found, and may be considered sufficiently dealt with under (b), where similar conditions exist.

5. *Causes temporary obstruction.*—A foreign body may be the cause of temporary obstruction, arising either shortly after it has entered the bowel or much later, when it has caused ulceration and possibly led to stricture.

When the cause remains after the symptoms have subsided, there is a likelihood of recurrence at some future date, with the possibility that the subacute or temporary attack may at any time become acute and fatal. This latter result is most liable to occur where stricture is the cause of the obstruction. In such cases it needs but an effectual plug to completely block the narrowed aperture to produce acute obstruction.

The symptoms of temporary obstruction are mostly those of the acute form, only in a much less marked degree. The patient may vomit, pass neither faeces nor flatus *per rectum*, although suffering from constant tenesmus. There will be a feeling of abdominal discomfort which may amount to pain. There is usually an absence of those general constitutional symptoms which present such a marked feature in the acute form. The pulse is normal, the face not pinched or sunken, the tongue moist, and the patient not painfully distressed. The attack may last for two or three days, when flatus begins to pass, faeces follow, and all the symptoms subside.

In treating this condition the patient should be confined to bed. Purgatives should be avoided, but small doses of belladonna combined with a little opium should be administered. The rectum and lower part of the large bowel should be emptied by the use of large fluid enemata, which may be repeated some three or four times. Nourishment should be limited to milk and easily digested soups and other

fluid material. The stomach, however, will probably tolerate but little, and should not therefore be burdened with too much of anything.

CASE LXIX.—*Temporary intestinal obstruction from ingestion of a quantity of gooseberry skins.*

Miss B., aged 55 years, ate a quantity of gooseberry skins, the residuum of some preserves she was making. On the following day she was attacked with abdominal pain, which increased in severity and was accompanied by vomiting. There was complete constipation, with passage neither of *faeces* nor *flatus*. Abdominal distension took place, and the patient complained of 'screwing' sensations within her abdomen. Her pulse and temperature were normal. Tongue moist. Large enemas were administered, after one of which a copious motion followed; for some days subsequently exceedingly large motions were passed. All symptoms subsided, and the patient rapidly recovered. (J. Grant Andrew and A. Ernest Maylard, Private Case Book.)

6. *Causes acute intestinal obstruction.*—A fuller description of acute obstruction from causes of this character will be found later on, but it may be briefly alluded to here.

The causes which give rise to temporary obstruction may equally lead to the acute, fatal, form. A good illustration of acute obstruction is afforded by a case published by Eve<sup>1</sup> of a 'human ostrich.' A man in order to gain a livelihood swallowed 'penny pieces, halfpence, pieces of tin, paper, cork, swivels, watch chains, keys, tin tacks, nails, pieces of india-rubber, sovereign purses, &c.' He was suddenly seized with pain in the abdomen, in the region of the umbilicus, from which time symptoms of obstruction set in, ending fatally in five days. At the post mortem the lower end of the ileum was found completely blocked with these various objects.

In some instances it may be possible to trace the symptoms to their true cause; more frequently, however, a considerable time elapses between the ingestion of the body, or its passage into the bowel, and the onset of acute symptoms. Such was the sequence of events in the above case, where the man considered that he had long since passed *per rectum* all the various articles which he had swallowed. In cases of stricture resulting from ulceration the effect of an impacted foreign

<sup>1</sup> *Brit. Med. Journ.* 1894, vol. i. p. 963.

body, it is hardly likely that the true cause of the sudden obstruction will be correctly divined, although there may previously have existed symptoms indicative of chronic obstruction. (See also Obstruction from Gall Stones.)

7. *Effects produced by wandering needles.*—It occasionally happens that needles swallowed find their way through the tissues with comparatively slight inconvenience to the patient. It would appear that these are about the only foreign bodies which having passed out of the bowel may become encysted, and so remain for indefinite periods embedded in the tissues. Poel relates a case illustrative of both these conditions. The patient, as will be seen from the case narrated below, never suffered pain except when a needle began to perforate the abdominal parietes, but after its removal all symptoms disappeared until another presented itself. After death from another cause, needles were found encysted in the deep tissues.

CASE LXX.—*Wandering and encysted needles.*

A seamstress was admitted into hospital suffering from acute colicky pains which had troubled her for some three or four weeks. The pain was referred to the lower part of the abdomen and the vagina, and in consequence she was unable to assume an erect position or walk without greatly increasing the discomfort. Upon examination a narrow body about two inches in length was discovered embedded in the abdominal wall, which caused great pain on manipulation. It was cut down upon, and an ordinary sewing needle was removed. The symptoms then subsided, except that slight abdominal pain still lingered. A second needle was removed somewhat later, but this had been the means of causing only slight discomfort. She was admitted into hospital about a year later with symptoms the result apparently of fatty liver, from which the report states she died. At the post mortem six needles were found embedded in the omentum at one place, and two others at another. Other needles, either singly or together, were found practically encysted, as no signs of inflammation existed, and the tissues around were so dense that they needed to be torn before removal could be effected.

It was ascertained that three years before her admission into the hospital two needles had been extracted, one after an incision, and one by the aid of the fingers. Similar symptoms were present, and relief followed upon removal. (Poel, 'Medical Record,' 1883, vol. xxiii. p. 587.)

Cases of peculiar interest are occasionally met with. Thus Dunlap<sup>1</sup> records a case of rupture of the bowel the

<sup>1</sup> *New York Med. Journ.* 1893, vol. lvii. p. 166.



result of a tapeworm, which he believed had become entangled, and in the efforts made to free itself, had so eroded the wall as to cause rupture. Again, cases are not infrequently recorded of foreign bodies getting into a herniated loop of bowel. The body becomes impacted, and changes are set up which lead to symptoms suggestive of strangulated hernia. Such was the condition in a case narrated by Shiach,<sup>1</sup> where a triangular piece of bone got lodged in a femoral hernia.

---

## CHAPTER XL

### TUBERCULAR AND TYPHOID ULCERATION

THE small intestine may be affected by many forms of ulceration, but it is only necessary to consider here two kinds, tubercular and typhoid, which are liable to give rise to complications calling for surgical intervention.

**Tubercular ulceration.**—This form of ulceration, so frequently met with in advanced cases of pulmonary phthisis, affects mostly the lower part of the ileum, although any portion of the canal up to the duodenum may be involved. The tubercular process attacks almost exclusively Peyer's patches and the solitary glands. At an early stage of the disease the glands contain numerous grey granules which later form yellow cheesy masses, and these latter breaking down give rise to the ulcer. The tendency is for the process to extend transversely in the direction of the blood vessels, so that in extreme instances the bowel is completely encircled by ulceration. Invasion may also take place in a longitudinal direction, producing therefore ulcers of considerable variety in size and shape.

The ulcer in its most typical form presents an excavated appearance, with thickened overhanging edges and an irregularly tuberculated floor (see fig. 46). The inflammatory thickening which precedes the process of ulceration tends to prevent perforation, although in exceptional instances this latter result ensues.

While ulceration is progressing in one part of the ulcer, cicatrization may be taking place in another; and where in

<sup>1</sup> *Brit. Med. Journ.* 1893, vol. i. p. 323.

any case the ulcer has extended entirely round the bowel, the subsequent healing may lead to stenosis at that particular part. Voehls<sup>1</sup> records a case where two strictures were formed; the intestinal convolutions were also found to be injected and infiltrated with miliary tubercles.

Occasionally adhesions take place between the floor of the ulcer and neighbouring parts. In one case which came under my own observation, the bowel had become adherent to the parietes on the left side of the umbilicus; a chronic tubercular abscess formed, and pointed beneath the skin. The abscess was opened and scraped. A few days later a faecal fistula unexpectedly appeared. The patient eventually

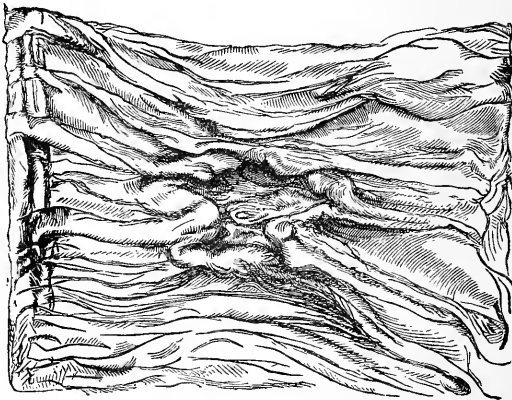

FIG. 46.—TUBERCULAR ULCER OF INTESTINE. NAKED-EYE APPEARANCE. (Coats)  
The swollen overhanging edges are indicated

died, when it was shown at the post mortem that the tubercular process was one which had extended from the bowel outwards through the parietes.

**Symptoms.**—The symptoms connected with tubercular ulceration of the bowels are in many instances not specially distinctive. When the lower part of the ileum is markedly involved there may be tenderness and more or less pain in the right iliac fossa. The bowels may move freely, amounting in the severer forms to obstinate and uncontrollable diarrhœa; in other cases there may be constipation. When the bowel symptoms are marked, other constitutional disturbances will become

<sup>1</sup> *Annals of Surgery*, 1893, vol. xviii. p. 579.

manifest, such as emaciation, hectic, night sweating, and those many well-recognised indications of advancing tuberculosis in other parts. For a further and more detailed description of these conditions, medical works should be consulted.

**Treatment.**—From a surgical point of view it is only necessary to consider the possible complications, such as perforation, stricture, and localised abscess. So far as these are concerned, they are all too rarely met with to admit of any statement regarding treatment other than that which is included under general surgical principles. If other circumstances allowed, perforation might be reasonably dealt with in the same way as in the case of perforations occurring from other causes ; and as regards stricture some form of plastic operation may be required. In Voelke's case, already alluded to, the strictures were successfully excised. An abscess arising in connection with an ulcer should be opened and drained without further interference in the way of scraping.

**Typhoid ulceration.**—Ulceration of the bowel in typhoid fever presents some features of marked contrast to that of tubercular ulceration. One of the chief points of distinction is the tendency of the former to perforation, and in this particular feature it contributes the one important factor of interest to the surgeon.

Inasmuch as the process of ulceration attacks the solitary and agminated follicles, the ulcers are found wherever these glands normally exist. Thus, then, they are most prominently present in the lower part of the ileum. The ulcer in its most typical form assumes the size and outline of the follicle attacked ; in the case of agminated follicles or Peyer's patches, it is oval and in the longitudinal axis of the bowel. It contains either a yellowish slough on the point of separation, or the shreddy remnants of one which has become detached. The floor of the ulcer after separation of the sloughs is thin and may be formed of the muscular coat, or, in cases where the ulcer is approaching perforation, nothing but the thin serous coat may intervene.

The result of ulceration is to produce either a localised abscess or general peritonitis. The former, from its excessive rarity, may be passed over, although the possibility of its occurrence should be borne in mind. The latter is not

infrequent, and almost without exception fatal. Cases have been reported where it is supposed perforation has taken place and recovery ensued. There is, however, the great difficulty of deciding with any degree of certainty whether in these cases of recovery perforation did actually take place. And, further, there is the question whether the supposed perforation might not have been due to some other concurrent disorder. Thus the case recorded by McCall<sup>1</sup> was called into question by Barr,<sup>2</sup> who considered it an ordinary case of appendicitis. Remembering, however, that both the cæcum and the appendix may be the seat of typhoid ulceration and perforation; and that in this particular instance the patient had been nursing her son who was recovering from an attack of typhoid, and that her own symptoms as narrated were quite typically those of the disease, there is considerable weight on the side of believing that the case was, as reported, one of recovery after perforation.

Other cases of supposed recovery after perforation are reported. Thus De Souza Martius<sup>3</sup> records three cases and Branson<sup>4</sup> one. The treatment in Martius's cases consisted of morphine internally, ice to the abdomen, and iced milk and champagne to drink; while in Branson's, opium was given. Simon<sup>5</sup> records a case in which the occurrence of perforation was indicated by a great drop in the temperature, by collapse, and the rapid distension of the abdomen, even the liver dulness being lost. Large doses of opium were given and recovery followed. The conviction that perforation had taken place was shared by two other medical attendants.

Hawkins<sup>6</sup> has contributed some valuable statistics with regard to the frequency of perforation, the period of occurrence, and the seat of perforation.

*Frequency of perforation.*—In the case of children from 2 years to 15 inclusive, out of twenty which were fatal in a total of 251 cases of typhoid, six owed their death to perforation. In adults a similar number of investigations showed a

<sup>1</sup> *Brit. Med. Journ.* 1893, vol. ii. p. 62.

<sup>2</sup> *Ibid.* p. 207.

<sup>3</sup> *Annual of the Universal Medical Sciences*, 1890, vol. i. H—33.

<sup>4</sup> *Lancet*, 1889, vol. ii. p. 889.

<sup>5</sup> *B. Med. Journ.* 1896, vol. i. p. 711.

<sup>6</sup> *Lancet*, 1893, vol. ii. p. 245.

PLATE XV.

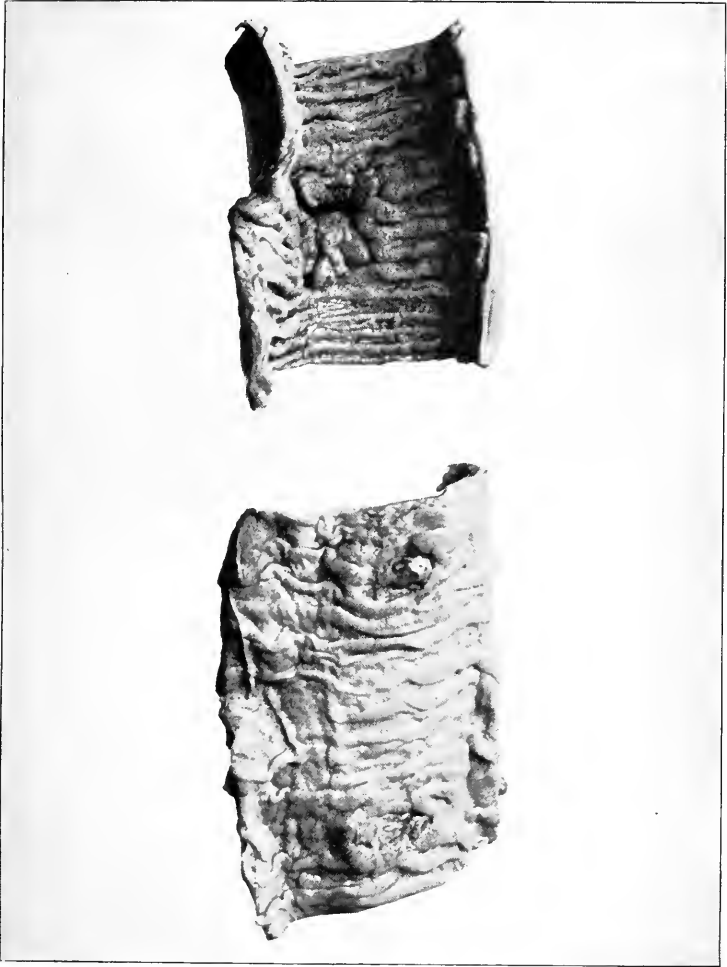

Fig. 47.—TYPHOID ULCERATION AND PERFORATION.—The upper specimen has a piece of whalebone passing through a perforation in the centre of a slough, which had caused peritonitis. (*H.J.M., Glas.*)



mortality of forty-three, out of which eighteen died from perforation.

*Period of occurrence.*—In children perforation occurred during the third week in one case, during the fourth week in two cases, during the ninth week in one case, and during a relapse in two cases.

In adults the perforation occurred during the second week in two cases, during the third week in six cases (at the early part in three cases, in the middle in one, and at the end in two cases), at the end of the fourth week in two instances, during the sixth week in one case, during the seventh week in two cases, and during the eighth in one. The dates in the remaining four cases are not given.

*Seat of perforation.*—As the result of an investigation of seventy-two necropsies where perforation had caused death, Hawkins found that in sixty-one instances the ileum was perforated at distances above the ileo-cæcal valve varying from one inch to six feet, being in the majority of instances six, twelve, and twenty-four inches. In the remaining eleven cases the perforation was situated as follows: the colon in five instances, the anterior surface of the cæcum in three, and the cæcal appendix in three. Of the five perforations in the colon one was in the ascending colon, an inch above the cæcum (there being also a perforation in the ileum), another in the transverse colon, and three in the descending colon, two being in the upper part and one in the sigmoid flexure.

In no case was a perforation found in the duodenum or the jejunum.

There are facts in these statistics of considerable practical value to the surgeon. In the first place, it will be noted that by far the largest number of perforations take place within the first twenty-four inches of the cæcal extremity of the ileum; in the second, that the jejunum is almost always exempt from perforation. Again, in the seventy-two cases where death occurred from perforation, in only one instance is it noted that a second perforation existed. The value of these facts considered in regard to operation will be alluded to later.

*Symptoms.*—In all but exceptional cases perforation takes place during the obvious progress of the disease. The exceptional instances are those where the patient, though feeling

possibly unwell, is continuing his customary avocation when suddenly he is seized with acute symptoms.

The symptoms connected with perforation appear to be more manifestly acute when the patient is not suffering markedly in other respects from the effects of the fever poison. Thus a patient who has only a mild attack of typhoid, or who is making apparently good progress towards recovery, becomes attacked with intense abdominal pain, collapse, vomiting, tenderness over the abdomen with distension, and other symptoms indicative of progressing general peritonitis. On the other hand, a patient who is already seriously ill from the disease will present much slighter indications; the sudden onset of a change however, marked it may be by signs of collapse, with a fall in temperature, increased rapidity and feebleness of pulse, rapid thoracic respiration, and distension of the abdomen, should be looked upon as indicative of perforation. 'The sudden appearance in the course of enteric fever of symptoms of intense collapse even when no distinct evidence of abdominal inflammation is present, points to the occurrence of perforation' (Bristowe).

**Treatment.**—The introduction of the question of operative intervention in the treatment of perforation is of comparatively recent date. According to Louis,<sup>1</sup> who has carefully investigated the subject, Leyden in May 1884 was the first to suggest treatment by laparotomy, while Mikulicz, who read a paper upon the subject in September of the same year, appears to have been the first to act upon the suggestion. The perforation was sutured and the patient recovered. In October of the following year (1885) Lücke operated upon a woman aged 28 years. Death ensued eleven hours after. Since these earlier operations several others have been performed, and according to some statistics published by White<sup>2</sup> in 1892, there had been nineteen recorded cases of laparotomy for perforation from typhoid ulcer, with four recoveries. More recently Senn<sup>3</sup> has recorded three cases with one recovery. In this instance the patient was a boy aged 15 years, who had been ill for five weeks. No perforation could be found, but a large

<sup>1</sup> *Le Progrès Médical*, 1890, vol. xii, p. 512.

<sup>2</sup> *Annual of the Universal Medical Sciences*, 1892, vol. iii, C—101.

<sup>3</sup> *Ibid.* 1893, vol. iii, C—77.



quantity of faecal matter was washed out of the abdominal cavity. Senn believed that the perforation had become closed by adhesions. Abbe<sup>1</sup> also records a case of recovery after operation. The patient was a woman aged 21 years, and symptoms of perforation developed at the end of three weeks of the fever, when convalescence had commenced. (See case below.)

The conditions of the patients in whom perforations take place vary so widely that the prospects of a successful operation in any particular case can only be properly reckoned by carefully taking them into account. Thus, to open the abdomen when perforation has occurred in a patient who is in the height of the disease and in a low typhoid condition can hardly be considered comparable, as regards the prospects of success, to one in whom convalescence has reached an advanced stage, and the patient therefore in a much more fit condition to stand the additional strain of an operation. In three of the successful cases (van Hook, Senn, Abbe) the patients do not appear to have been suffering deeply from the disease at the time of the operation. In one, perforation was during a relapse after convalescence had set in; in the second it was five weeks after the onset of the illness; and in the third it was three weeks, convalescence having set in.

The question of paramount importance to the surgeon when brought face to face with a case of perforation at any stage of the disease, is whether laparotomy should be performed. Louis, who reports eleven cases of operation, concludes that 'in no case could the operation be said to have increased the danger for the patient.' He therefore, like van Hook, considers that laparotomy is only contra-indicated when the patient is in a moribund condition. The latter author adds, 'the stage of the fever is not to be considered as an indication or as a contra-indication for laparotomy.' Mears,<sup>2</sup> at a meeting of the American Surgical Association in 1888, advocated operation only during the stage of convalescence, at the end of the third or fourth week. It will thus be seen that with some of those who have had most experience in dealing

<sup>1</sup> *Annals of Surgery*, 1895, vol. xxi. p. 362.

<sup>2</sup> *Annual of the Universal Medical Sciences*, 1889, vol. iii. B-42.

with this fatal complication of typhoid, no unanimity of opinion exists. The surgeon therefore, so far as our knowledge goes at present, must decide the question for himself. He needs to take into consideration the condition of the patient as regards the disease, and the amount of physical strength he possesses; and the means at his disposal for rapidly and efficiently carrying out the operation. While it is right to say in a general way that operation holds out the only hope, still there will be cases where such hope cannot reasonably be entertained, and the patient should not therefore be subjected to useless interference.

**Operation.**—Every means must be taken to operate with the greatest possible rapidity, and with a care which shall ensure the efficient closure of the perforation and the perfect cleansing of the peritoneal cavity.

The abdomen should be opened by a median incision below the umbilicus. The hand is then inserted, and the ileum at its junction with the cæcum sought for in the right iliac fossa. The ileum is examined by tracing it upwards or away from the cæcum. As soon as a perforation is met with, it should be brought sufficiently into view to enable sutures to be passed.

The perforation and the ulcer, of which it is a part, should be folded in, and the serous surfaces united over the ulcer by a series of Lembert sutures. The rarity of a second perforation renders it unnecessary to subject the patient to the prolonged exposure and manipulation necessary to examine the whole length of the intestinal canal. Such examination, however, must be carried out when failure to find the perforation in the more common seat of the iliac fossa happens.

After returning the sutured bowel the abdominal cavity must be carefully cleansed, either by irrigation with warm boiled water or by simply wiping out. If deemed advisable the neighbourhood of the intestinal wound should be stuffed with iodoform gauze. The pelvis must be carefully looked to, as also Douglas's pouch in females. A drainage tube may be used and conducted well down into the pelvis. The parietal wound is finally closed with the exception of the aperture left for the tube when the latter is used, or for the gauze stuffing when the deep parts are packed.

As modifications of this method of operating, Lücke's suggestion of making an artificial anus, by stitching the bowel at the seat of perforation to the parietal wound, may be carried out; and in female cases Douglas's pouch can be efficiently drained by a tube passed into it from the vagina. In Abbe's case no attempt was made to close the wound, a large abdominal tamponnade of iodoform gauze was placed within the abdomen and pelvis.

There is probably a preference for an artificial anus over immediate suture of the bowel in cases operated upon at an early stage of the disease. The free escape of gas and fæces which the artificial anus admits of, Mears considers as likely to secure the most perfect rest to the bowel, and lessen thereby the possibility of another perforation. Should the patient recover, the artificial anus can be successfully dealt with by an operation at some subsequent period.

CASE LXXI.—*Perforation of typhoid ulcer: laparotomy: suture of the perforation. Recovery.*

The patient had a slight attack of fever, lasting about three weeks. During convalescence a relapse occurred. On the seventh day of the supposed relapse an enema of warm water was given for the purpose of making the bowels move. This was followed by several passages, and by violent pain in the ileo-cæcal region, accompanied by profuse diaphoresis, coldness of the extremities, and an excessively pinched and anxious expression of the countenance. Temperature 105° F.; pulse 126. The pain ceased in a short time. In a few hours the temperature ran up to 106° F., the pulse to 132, and the patient suffered from tympanites and tenderness on pressure over the ileo-cæcal region. The abdomen was opened as soon as possible, and more than a pint of fluid fæces and exudate mixed with flocculent lymph was removed. On exposing the small intestine numerous ulcers were seen; all the coils of the intestine were congested and dull-looking; and the fæcal matter was freely circulating in the peritoneal sac. A perfectly circular minute opening was found. This was closed by means of the Lembert suture, three rows being applied on account of the brittle condition of the gut wall. The peritoneal cavity was thoroughly cleansed out with hot sterilised water. The omentum was drawn over the injured coil of intestine and sutured to the mesentery. Douglas's cul-de-sac was drained, and the remainder of the abdominal wound was closed. Great distension followed the operation. This yielded to enemata of sulphate of magnesium with glycerine and water. The patient recovered. (Van Hook, 'Annual of the Universal Medical Sciences,' 1892, vol. iii. C—100.)

CASE LXXII.—*Perforation of typhoid ulcer : laparotomy : suture of the perforation. Recovery.*

The patient, a woman, 21 years of age, at the end of three weeks of typhoid fever, convalescence having begun, developed symptoms of perforation of the bowel. For two days she was treated by poultices and opium, when Dr. Abbe saw her. Her abdomen was then greatly distended; pulse 140; temperature 104° F.; lower part of the hypogastrium dull. A median incision below the navel exposed distended coils of deeply congested and greatly inflamed intestine smeared with sticky lymph. The pelvis and lower abdomen were filled with a collection of foul, purulent and fetid intestinal extravasation, feebly confined by matted coils of intestines loosely glued together, that broke apart on being touched, but which, being recognised, enabled him to introduce clean sponges under the upper abdominal wall. Two pints of foul, purulent fluid and thick lymph were cleaned out, and the abdomen irrigated with warm sublimate solution (1 to 20,000), followed by plain warm water irrigation. On the lower part of the ileum were then seen many thick oval patches, in one of which was a gangrenous perforation a quarter of an inch in diameter, from which intestinal contents were seen to pump out. This was closed by interrupted silk suture, over which two layers of mattress stitches were placed. A large abdominal tamponnade of iodoform gauze was placed within the abdomen and pelvis, and no attempt made to close the wound. An enema of hot black coffee and whisky was given, and the patient put back to bed three-quarters of an hour from the beginning of the etherisation. At the end of forty-eight hours she was in good condition, except for tympanites. The tampon was changed and five grains of calomel given. A little fluid fæces leaked from the wound after the calomel acted; this continued for two weeks and then it ceased. The abdominal wall closed in rapidly by granulations, forming finally a narrow and firm scar: The convalescence was rapid. (Abbe, 'Annals of Surgery,' 1895, vol. xxi. p. 362.)

Considerable interest attaches to this latter case of Abbe's, in addition to that connected with the successful treatment of the perforation. The operation, it will be observed, was not performed until two days had elapsed from the time at which perforation took place, and then extensive general purulent peritonitis with copious fæcal extravasation was found to be present. It lends encouragement, where one is too frequently apt to lose heart, to deal most thoroughly and carefully with every case of general peritonitis arising from whatever cause, when the condition is met with in the ordinary course of operation.

## CHAPTER XLI

## OBSTRUCTION

1. INTERNAL HERNIA
  - (A) INTO NORMAL PERITONEAL FOSSÆ
  - (B) THROUGH ADVENTITIOUS OR CONGENITAL APERTURES
  - (C) UNDER BANDS, CORDS, DIVERTICULA, &C.
2. ADHESIONS, KINKING
3. INTUSSUSCEPTION
4. VOLVULUS
5. STRICTURE
6. GALL STONES, INTESTINAL CONCRETIONS
7. TUMOURS OF THE BOWEL WALL
8. PRESSURE FROM WITHOUT
9. PERITONITIS, ENTERITIS
10. CONGENITAL ABNORMALITIES, MALDEVELOPMENT

WHILE it is usual in most textbooks to treat, under the head of Intestinal Obstruction, the large as well as the small intestine, I have preferred to keep to the original scheme I had in view of dealing as far as possible with certain regions, only combining portions where the affections involving them are practically inseparable.

The part played by the jejunum and ileum in intestinal obstruction comprises considerably more than that of any other portion of the alimentary tract. The greater length of this section of the canal, its greater mobility and more exposed position, naturally predispose it to sources of obstruction not met with in other parts.

Obstruction of either the jejunum or the ileum may be brought about by causes external or internal to the canal, but not organically connected with it, and by changes involving the bowel wall itself. Remembering this and the fact that this section of the alimentary canal consists of a long tube, freely movable, with soft and easily compressible walls, it requires very little effort to conjure up in the mind the various conditions which might prove the direct source of obstruction. Thus the tube may become blocked, bent, twisted, compressed,

kinked, and so on. But such conditions need to be technically expressed, and their enumeration, as expressed in the heading of the chapter, forms the basis for their consideration.

1. **Internal hernia (A) into normal peritoneal fossæ.**—Anatomically, and independent of the common parietal seats of hernia, there may be said to exist within the abdomen four situations in which a loop of intestine may become strangulated. Three of these are classed as retroperitoneal; the bowel passes into fossæ which are formed of pouches of peritoneum lying between the parietal layer of that membrane and the muscles. One of these fossæ is known as the ‘duodeno-jejunal’ and is situated, as the name implies, at the end of the duodenum, close to its junction with the jejunum. The pocket which normally exists there is formed by the reflection of the parietal peritoneum to the duodenum.

A second is that known as the ‘pericæcal,’ and comprises several fossæ situated around that particular portion of the bowel; the commonest seat is behind the cæcum—‘retrocæcal.’

The third is termed ‘intersigmoid;’ a fossa which is found at the root of the pelvic meso-colon.

The fourth seat of internal hernia, through a natural aperture, is that through the foramen of Winslow.

In cases where acute strangulation occurs in one of these situations, it is not always easy to determine the exact position of the peritoneal pouch at the time of operation. It is only when a careful post-mortem dissection is made that the situation of the constricting fossa can be accurately located. Thus in many of the recorded cases the nature of the hernia is only indefinitely stated, and it is not possible to classify it in one or other of the situations above described.

In a case recorded by Jackson Clarke,<sup>1</sup> the sac is described ‘as consisting of that part of the mesentery which lies between the superior mesenteric vessels and the attachment of the mesentery to the posterior abdominal wall,’ and would therefore appear to be of the duodeno-jejunal variety. In a case reported by Robson,<sup>2</sup> a loop of small intestine became

<sup>1</sup> *Trans. Path. Soc. Lond.* 1893, vol. xliv. p. 67.

<sup>2</sup> *Brit. Med. Journ.* 1889, vol. i. p. 656.

involved in an opening in the parietal peritoneum, about an inch above the crest of the ileum on the right side. This case would appear to be an illustration of the retrocaecal variety. Another case of the duodeno-jejunal form, and similar therefore to Clarke's, is recorded by A. G. Barrs.<sup>1</sup> Pye-Smith and Astley Cooper<sup>2</sup> have also reported cases, the former having treated the subject somewhat fully. The reader, however, who wishes to consult one of the most complete and exhaustive disquisitions upon the subject is referred to the work by Jonnesco.<sup>3</sup>

CASE LXXIII.—*Hernia of a portion of the ileum into the fossa duodeno-jejunalis: strangulation: laparotomy. Death.*

A man aged 21 years was admitted into hospital on August 21, 1892. Two days before he had been attacked by sudden pain referred to the right iliac region, and with vomiting. The pain became so severe as to require hypodermic injections of morphia for its relief. The vomiting became persistent, the constipation complete, and the prostration extreme. Tenderness was more marked beneath the right rectus muscle and below the level of the umbilicus than elsewhere. A median incision was made, when a hernia of a portion of the ileum into the fossa duodeno-jejunalis was found. The patient failed to rally, and died in twelve hours. The symptoms resembling so much those of appendicitis, it was thought to be probably a case of that nature. (George Ryerson Fowler, 'Annals of Surgery,' 1894, vol. xix. p. 166.)

(B) **Strangulation through adventitious or congenital apertures.**—Cases occasionally occur where a loop of intestine becomes strangulated through a slit or aperture in some membranous expansion, either normal or pathological. Thus, as the result usually of some antecedent accident, a slit is produced in the mesentery, and through this a loop of bowel slips and becomes strangulated. In other instances the slit has been formed in a membranous band or expansion the result of stretched adhesions. In illustration of the former, Hector Cameron<sup>4</sup> alluded to a case in the discussion on acute intestinal obstruction, held in Glasgow, of a man who had been kicked in the abdomen a year or two previously. The injury resulted at the time in a very serious illness, followed by

<sup>1</sup> *Lancet*, 1891, vol. ii. p. 286.

<sup>2</sup> *Guy's Hospital Reports*, 1871, vol. xvi. p. 131.

<sup>3</sup> *Hernies Internes Rétro-péritonéales*, 1890.

<sup>4</sup> *Trans. Path. and Clin. Soc. Glasgow*, 1893, vol. iv. p. 78.

vomiting and abdominal distension. The patient when seen on the present occasion was moribund from acute obstruction. At the post mortem, it was found that 'the mesentery had been torn away at one point from its attachment to the bowel, and through a round hole thus produced, a loop of gut had passed, been strangulated and rendered gangrenous.'

In some cases it would appear that these slits in the mesentery may be of congenital origin. Such, for instance, seems to have been the explanation of a specimen exhibited by Joseph Coats<sup>1</sup> at the same discussion. The edges of the aperture in the mesentery through which the small intestine had passed and become strangulated were smooth, rounded, and presented no appearance of a recent scar. In a case recorded by Rushton Parker,<sup>2</sup> where a loop of ileum passed through an aperture in the mesentery and became strangulated, the mesenteric perforation was supposed to be due to a perityphlitis, from which the patient had suffered some time previously.

The only case of this kind which has come under my own observation, I believe to have been an illustration of an adventitious aperture. About four feet of the ileum, eight inches above the ileo-cæcal valve, had passed through an aperture in the mesentery close to its spinal attachment. The edges of the opening were thickened and smooth. The bowel was acutely constricted, and the four feet ensnared were in an advanced state of gangrene. The history of the case, as detailed below, tends to show that some lesion of the mesentery took place three years previously, when the child was run over by a cart.

CASE LXXIV.—*Strangulation of the ileum through an aperture in the mesentery: operation. Death.*

J. G., aged 12 years, was admitted to the Victoria Infirmary at 7 A.M. on Monday, June 24, 1895. His symptoms commenced on the previous Thursday (June 20) by a severe attack of colic. This, however, passed off, and on the following day (Friday) he was back at school, apparently in his usual health. On Saturday he was away at a school trip, and does not appear to have suffered in any way. His bowels had not been moved, and as on Sunday morning he was again seized with severe colic, his

<sup>1</sup> *Trans. Path. and Clin. Soc. Glasgow*, 1893, vol. iv. p. 57.

<sup>2</sup> *Brit. Med. Journ.* 1893, vol. ii. p. 1373.



parents administered some aperient medicine ; this was vomited, and from henceforth the attempt to take anything was followed by its ejection. The pain continuing, and the boy looking much worse, he was brought to the infirmary. On admission, he was in a somewhat drowsy state, lying partly on his side, with his thighs slightly flexed upon the abdomen. There was pallor of the cheeks, and some darkness and depression below the eyes. Skin cool, no perspiration. No complaint of pain except when the abdomen was handled. Respiration partly thoracic. Tongue moist ; complained of thirst ; vomited occasionally a little mucus ; but vomiting had not been a marked feature, and usually associated with taking anything by the mouth. No passage of fæces or flatus, no urine passed. Pulse about 150 and very feeble. Temperature 99° F.

On examination of the abdomen the parietes were found rigid : there was some distension : no visible peristalsis. On percussion a resonant sound was obtained all over ; the note, however, was dulled in the lower regions. Palpation caused pain, especially over the iliac and hypogastric regions. At 11.30 A.M., four and a half hours after admission, and the fifth day after the onset of the symptoms, the abdomen was opened. A quantity of blood-stained fluid immediately escaped. It possessed an unpleasant, close odour, but not distinctly fæcal. Some distended, almost black, coils of intestine presented. A search soon revealed the nature of the condition. A long loop of ileum—about four feet—at a distance of eight inches from the ileo-cæcal valve, had passed through an aperture in the mesentery close to its spinal attachment. The opening, which appeared small enough to admit only the tip of the little finger, was enlarged and the bowel withdrawn. The bowel was completely gangrenous, and had therefore to be removed. The free ends of the normal intestine were approximated by a medium-sized Murphy's button, and the rent in the mesentery stitched up. The abdominal cavity was finally freely flushed out with hot water. At this stage, however, the pulse failed, and the patient, who had been gradually looking much worse, succumbed just at the completion of the operation, which had lasted a little under the hour.

It was subsequently ascertained from the friends that the boy, three years before, was run over by a cart, the wheel passing obliquely across the thorax and abdomen. He complained of pain in the abdomen, which was relieved by hot fomentations and opium. He was kept in bed for a week, after which he got up and had remained well until his present attack. (A. Ernest Maylard, Clinical Reports, 1895.)

Well as this boy appears to have been between his attack of colic on the Thursday morning and his second attack on Sunday morning, it hardly seems possible that the advanced condition of gangrene which existed had arisen within the thirty hours which elapsed between the operation and his second seizure. It is probable that some engagement of the loop had taken place on the first day, and that no action of

the bowels took place after seems further to support such a view. If this be the correct aspect of the case, it remains a remarkable fact that for the two intervening days the boy was going about as usual, with no evidence of any illness or even discomfort. But for the history of an accident, the smooth and thickened edges of the aperture might have suggested its congenital origin. With, however, such clear and unmistakable evidence of an accident so likely to produce the very lesion found, there is no need to suspect a cause which, independently of its giving rise to strangulation, is so little known.

---

## CHAPTER XLII

### INTERNAL HERNIA (*continued*): (C) UNDER BANDS, CORDS, DIVERTICULA, &C.

IN the larger number of cases of internal strangulation the cause is found to be some form of band. It is usual to classify bands according to the structure out of which they are formed. It is thus possible to differentiate three kinds :

- (1) Adventitious, the result of stretched adhesions.
- (2) Meckel's diverticulum.
- (3) Normal anatomical structures.

(1) *Adventitious bands* arise usually from some antecedent local inflammation which has led at the time to a local peritonitis. The resulting adhesions subsequently stretch and give rise to bands, solitary or multiple, which in various ways cause strangulation of the bowel.

Some of the commonest causes of these local peritoneal attacks are, inflammation around the cæcum and appendix ; pelvic cellulitis ; ulceration of bowel ; inflamed mesenteric glands ; abdominal operations ; operations for external herniæ ; and injuries.

In cases where the bands are multiple, the previous peritonitic attack has been general rather than local ; and in such instances the cause is usually found to be tuberculosis. Of six cases of strangulation by bands, reported by Joseph Coats at the Glasgow discussion above referred to, four owed their origin to healed tuberculosis

Regarding the size, length, and attachments of these adventitious bands the utmost variation exists; and for a full and detailed account of these conditions the reader cannot do better than consult Treves's excellent monograph on Acute Intestinal Obstruction, or Leichtenstern's classical article in Ziemssen's 'Cyclopædia of Medicine.'<sup>1</sup>

It may, however, be briefly noted here that, inasmuch as the chief determining feature of the position and attachment of a band is the situation of the inflammatory focus to which it owes its origin, bands may be expected to be found running between any parts or structures which have become, by natural proximity, glued to the primary seat of inflammation. Thus, then, bands may be found extending between two portions of bowel (see fig. 48), between bowel and parietes, between bowel and mesentery or omentum, between the bowel or parietes and any of the female pelvic organs.

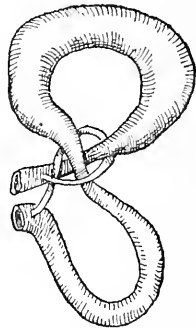

FIG. 48.—STRANGULATION OF A LOOP OF SMALL INTESTINE BY A FIBROUS BAND PASSING BETWEEN THE TWO PARTS OF THE GUT AND FORMING A KNOT AROUND A LOOP. (Museum 'Catalogue,' Western Infirmary, Glasgow)

In cases where adhesions form between the bowel and the mesentery or omentum, these latter are liable to be drawn upon so as to constitute in themselves cords capable of strangulating a loop of intestine.

There are numerous ways by which a band may cause obstruction. One of the most frequent and simplest is for a loop of small intestine to slip beneath the cord, which if not tense at the time may rapidly become so. A loop thus caught, sometimes rotates, and if not actually strangulated by the band, becomes completely obstructed by the accidentally produced volvulus. A most complicated method of strangulation is for the bowel to become snared by a knot or noose. This can only happen when the band is sufficiently long and the mesentery admits of the torsion and movement of the gut necessary for its production.

<sup>1</sup> Vol. vii. p. 561.

(2) *Meckel's diverticulum*.—This constitutes the remnant of the vitelline duct. It is usually found about thirty inches from the cæcum, and, according to Allen,<sup>1</sup> may be found at any spot between fifteen inches and three feet from the ileo-cæcal valve. It varies considerably in length and patency. From forming a simple pouchlike projection from the ileum, it may extend to the umbilicus, where, when patent, it constitutes one of the forms of umbilical fistula. In some cases the diverticulum is only patent throughout a certain portion of its extent, the remaining part being little more than a fibrous band.

The diverticulum, when unconnected with the umbilicus, may remain free in its distal extremity or become attached to some neighbouring organ or tissue. In both conditions it is capable of strangulating a loop of intestine. When free, it strangulates by tying a simple knot round the bowel; when attached, it constitutes a band beneath which a loop slips, and becomes strangulated as in the case of adventitious cords. As illustrating this latter method, a case which came under my observation affords a good example (see fig. 50). The diverticulum was attached by its apex to a band which itself was adherent to some enlarged glands in the mesentery. Beneath this a loop of ileum slipped and became strangulated. Additional interest attaches to the case from the effect produced by the tension of the band upon the diverticulum. This latter was found to be gangrenous in almost its entire length. Oderfeld<sup>2</sup> reports a somewhat similar case where the diverticulum was attached to the mesentery.

(3) *Strangulation produced by normal structures*.—The vermiform appendix, the Fallopian tube, the appendices epiploicæ, by becoming attached to neighbouring parts, may form bands beneath which coils of bowel can pass and become strangulated.

In the case of the two former it usually arises from some inflammatory mischief connected with the part. This, by causing a localised peritoneal inflammation, leads to a permanent adhesion, which, as the result of subsequent traction, becomes drawn out into a bandlike form. In the case of the

<sup>1</sup> *Annual of the Universal Medical Sciences*, 1893, vol. iii. C—56.

<sup>2</sup> *Lancet*, 1892, vol. i. p. 273.

appendices epiploicæ, it is these latter which become attached by a local peritoneal adhesion, either to each other or to some neighbouring part. In illustration of the former method two interesting cases recorded by Perry<sup>1</sup> are worthy of notice. In the first 'a loop four or five inches long had slipped between two adjacent appendices which were united by five thin adhesions at their tips. The pair of appendices were situated ten inches from the lower end of the rectum, and lay about two inches to the left of the vertebral column at the level of the

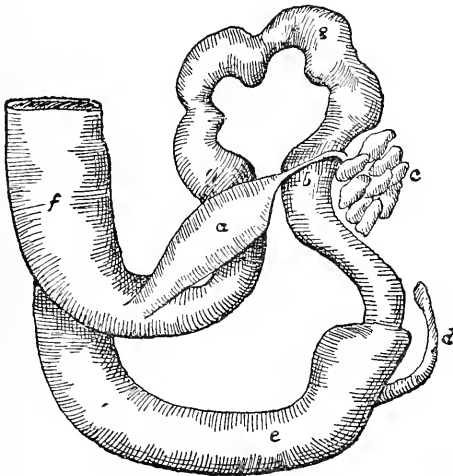

FIG. 50.—STRANGULATION OF A LOOP OF SMALL INTESTINE BENEATH MECKEL'S DIVERTICULUM

*a*, Meckel's diverticulum with cord *b* passing to enlarged glands *c* in mesentery; *d*, appendix attached to caecum *e*, and colon; *f*, dilated small intestine; *g*, ensnared loop

fifth lumbar vertebra.' In the second, 'about twelve inches from the lower end of the rectum on the left side, just below the brim of the pelvis, a pair of appendices, with their adjacent sides deeply congested, came into view, and their tips showed a rent in the serous covering as though they had been separated from each other.'

Among normal structures causing bands should also be included the omentum and mesentery; for these, becoming attached to some other spot, may be so drawn out as to constitute definite constricting agents.

<sup>1</sup> *Trans. Path. Soc. Lond.* 1889, vol. xl. p. 93.

**The method by which strangulation beneath a band is effected.** It is not difficult to understand the mode by which a loop of bowel is strangulated, if the analogy which this form of strangulation presents to that of an ordinary external hernia be borne in mind.

It may be that, like an ordinary hernia, a loop of intestine frequently finds its way beneath the band, but some altered position, or other agency, causes it to slip out again; or that a loop, instead of returning to its normal condition, becomes permanently retained, and, if not immediately, probably within a short time, strangulated.

In some instances it is not a matter of a loop slipping beneath a band, but of a band passing transversely across a section of the gut. In such cases the initial processes which bring about strangulation are frequently slow. Any sudden over-distension of the bowel above the band may cause pain and vomiting, which pass off so soon as the obstruction is relieved. But these attacks become repeated, until one at last proves sufficient to bring about a complete strangulation of the gut, at the point where it is crossed by the band.

The changes which bring about the retention of a loop beneath a band mostly concern the bowel itself. In some cases the bowel, after it passes beneath the band, becomes twisted; so that, while the band proves to be the cause of the volvulus, it is the latter which becomes the direct means of producing the obstruction. In most instances, however, it is probable that the changes which follow on constriction of the gut resemble those consequent on the strangulation of an ordinary external hernia. Either some gas finds its way into the loop, or is generated within it, and so distends it that the proper blood supply to the part is interfered with, or the constriction itself so directly compresses the mesentery that its vessels at once become practically occluded. The immediate result in either case is distension of the ensnared loop and engorgement of the intestinal walls. Unless this condition be rapidly relieved, gangrene soon follows.

**Symptoms.**—Internal strangulation, whether produced by bands or by apertures in the mesentery and other membranous expansions, or by retroperitoneal pouches, almost invariably gives rise to a series of sudden and acute symptoms. It must,

PLATE XVI.

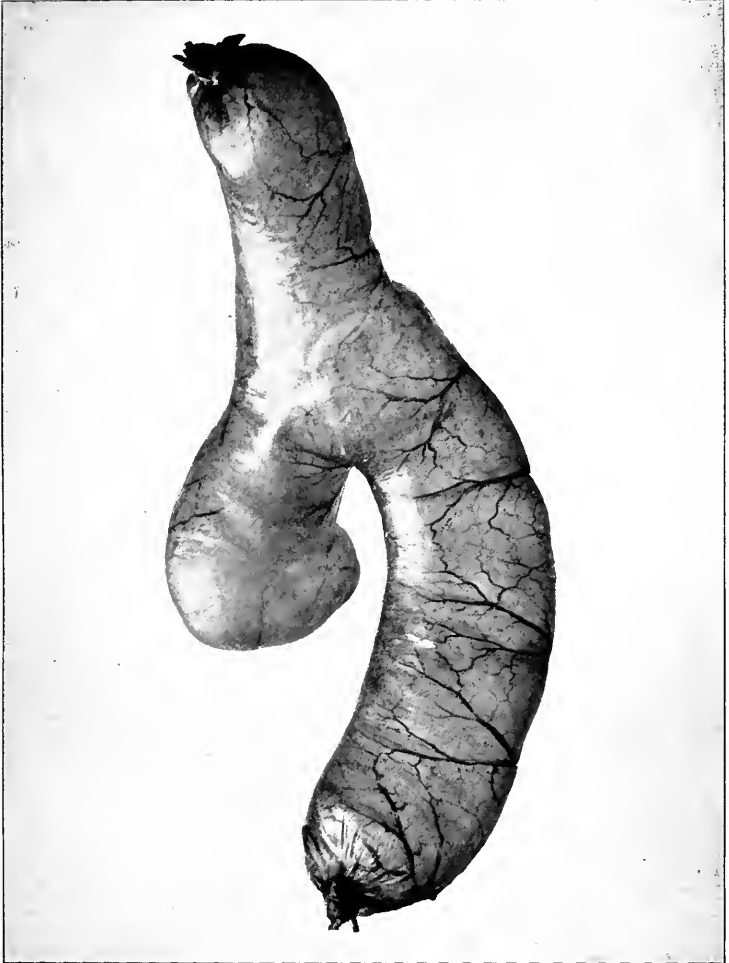

Fig. 49.—MECKEL'S DIVERTICULUM.—It is in the form of an elongated pouch about  $1\frac{3}{4}$  inches in length, and of about the same calibre as the intestine. It was situated about three feet above the ileo-cæcal valve. (*W.I.M., Glas.*)





however, be remembered, on the other hand, that it is possible for a loop to be only temporarily caught, and for the symptoms, rapid in their origin, as rapidly to disappear. In numerous instances of acute obstruction due to one of these causes, there have been well-marked histories of acute attacks of colic, with sometimes vomiting and other abdominal disturbances which, though transitory and obscure at the time, have been clearly due to the same cause which has brought about the fatal attack.

In considering therefore the symptoms of this class of case, no more instructive method can be adopted than by showing their analogy to those which follow upon the anatomically and pathologically similar conditions connected with external hernia.

A patient accustomed to return the bowel from an old inguinal or femoral sac, finds that, from some cause, he is unable to do so; pain and discomfort then commence to be felt in the part. As the bowel becomes gradually strangulated, vomiting sets in, there is obstipation, some abdominal pain, and general appearance of anxiety or depression. Such also may be the mode of attack in a case of internal strangulation; only, when once the bowel has become definitely strangulated, the abdominal symptoms present a more striking feature. The abdominal pain will be acute, the vomiting more urgent and persistent, and the physical expression of the patient suggestive of grave internal mischief.

In cases of herniæ into a congenital sac, hitherto unoccupied by a loop of bowel, we have frequently the acutest form of external strangulation, where the symptoms commence sharply, or rapidly become acute. Such is the probable explanation of those very acute cases of internal strangulation where the patient, perfectly well at the time, is suddenly struck down by the most agonising abdominal pain, a pain which doubles him up, causes vomiting, and is often followed by much collapse. As time progresses, the pain sometimes abates somewhat, but only to return again with renewed severity. In other cases it remains more or less constant, and the vomiting continues until it assumes a fæcal character. This latter state is not generally reached till the fourth or fifth day. Neither fæces nor flatus is passed. The abdomen does

not usually show any marked distension, meteorism being a later symptom, and indicative of peritonitis. Palpation of the abdomen may reveal some tenderness. While the pulse, temperature, and respiration may be normal for the first day or two, some rise may take place later; more frequently, however, the temperature falls, sometimes being subnormal. The tongue, clean and moist at the outset, becomes dry and foul later, and when fæcal vomiting has set in, great thirst is frequently complained of. The urine is usually scanty. The patient's mental condition remains intact, but the face often exhibits an aspect of anxiety; the features are pinched, and the eyes sunken and darkly underlined. Perspiration is sometimes profuse, and is seen to hang in innumerable drop-lets upon a pale and cold forehead. Cases, however, frequently occur where, beyond pallor, the skin of the face is but little altered.

If the patient lives long enough, and no operative measures are undertaken, peritonitis sets in. The abdomen now begins to distend, the pulse grows weaker and more rapid, some rise of temperature takes place, the respiration becomes shallower, more rapid, and partakes more of the thoracic character; vomiting, if not so violent, remains continuous, and death may be ushered in by slight convulsions.

Such is a brief outline of the course which an ordinary more or less typical acute attack may take. But, just as in the case of external strangulated herniæ, so with internal strangulation, the amount of collapse, or the degree and frequency of pain; the violence and persistency of the vomiting; the rapidity with which the symptoms succeed each other, may all vary within wide limits; and the variation is probably dependent upon the acuteness of the strangulation, and the disposition of the patient's nervous system. How slight may be the symptoms in some instances is well shown in a case reported by Marsh.<sup>1</sup> A boy was attacked with sickness after taking some unripe fruit, but there was only slight pain. The sickness remained for a day or two, when suddenly on the sixth day it returned and was fæcal. Throughout there was but little pain, no abdominal distension, but no movement

<sup>1</sup> *Lancet*, 1893, vol. i. p. 588.

of the bowels. The abdomen was opened, a band removed, and the boy recovered.

**Diagnosis.**—Regarding the symptoms as present in an acute case, there cannot be said to be any which it is possible to look upon as pathognomonic. So many causes of abdominal affections give rise to an almost precisely similar train of symptoms at the outset that in a vast majority of cases a diagnosis can be little more than conjectural. Importance, however, should always be attached to the previous history. It has been shown how frequently the bands which give rise to strangulation owe their origin to some distinct antecedent inflammatory cause. So that any history of an attack of appendicitis, of pelvic mischief in the female, of abdominal injury, of tubercular peritonitis, of tabes mesenterica, of abdominal operations, and of operations for external herniæ should be well considered, as also the history of any previous attacks of colic, vomiting, or intestinal disturbance. Oderfeld<sup>1</sup> states that the existence of hare-lip or the history of an umbilical fistula—features which suggest a tendency to some maldevelopment—should direct the attention to the possible existence of Meckel's diverticulum.

While, as shown by Leichtenstern's statistics quoted by Treves,<sup>2</sup> acute obstruction from bands is slightly more frequent in males than in females, and is commoner between the ages of 20 years and 40 years than at other periods, the frequency in neither case is sufficient to be of any practical service for diagnostic purposes.

When internal strangulation occurs in children, at which age intussusception is most common, the absence of any distinct tumour, as also the absence of any discharge of mucus and blood *per rectum*, should lead the surgeon to suspect the possible existence of strangulation by band; although it must be remembered that the absence of these symptoms, as will be shown later, does not necessarily preclude even the possibility of intussusception.

How rapidly a band may form capable of producing strangulation is well shown in a case recorded by Franklin.<sup>3</sup> The patient received a severe blow upon the abdomen. Four

<sup>1</sup> *Lancet*, 1892, vol. i. p. 273.

<sup>2</sup> Page 63.

<sup>3</sup> *Lancet*, 1892, vol. i. p. 273.

days after the accident severe abdominal pain commenced, followed by vomiting two days later, which rapidly became faecal. The band consisted of lymph.

**Treatment.**—If we continue the analogy between internal and external strangulation into the question of treatment, then we have but one course open to us, and that is to operate. No surgeon would delay to relieve a loop of gut strangulated in any one of the usual external apertures; neither should he hesitate to disengage a portion of bowel similarly situated in any other part of the body.

Ample proof is forthcoming of the value of opening the abdomen and liberating the ensnared loop. I have collected in the subjoined table cases which have been published since 1890, of successful operations performed for this form of strangulation. It did not seem to me that any useful purpose would be served by quoting also the unsuccessful cases, for the very good reason that no fair comparison can be drawn. It is possible that every successful case is published, but it is certain that every unsuccessful one is not. So that all that is really needful is to show from a sufficiently large number of successful cases that the operation does afford unmistakable evidence of curing an otherwise incurable and rapidly fatal condition.

*Table of Successful Operations for Internal Strangulation  
from 1891 to 1895 inclusive*

Operator	Nature of Constriction	Time intervening between onset of symptoms and operation	Nature of Operation	Reference
Monprofit	Band	4 days	Laparotomy and division of band	<i>Revue de Chirurgie</i> , 1891, p. 405
Rabagliati	Band (tag of omentum attached to small gut)	5 "	"	<i>Med. Press and Circular</i> , 1891, ii. 679
E. J. Cave	Band (attached to the umbilicus)	4 " (faecal vomiting)	"	<i>Lancet</i> , 1891, ii. 1213
Boiffin	Band	5 days	"	<i>Med. Press and Circular</i> , 1892, i. 422
"	Band	6 "	"	<i>Ibid.</i>
Irving	Band	3 "	"	<i>Brit. Med. Journ.</i> 1892, i. 916
Coates	Band	12 "	"	<i>Ibid.</i> p. 864

Operator	Nature of Constriction	Time intervening between onset of symptoms and operation	Nature of Operation	Reference
Nicolaysen .	Band consisting of appendix which formed half a knot. The loop was also twisted	5 days	Laparotomy and separation of band	<i>Brit. Med. Journ.</i> 1892, ii. 170
Oderfeld .	Band (Meckel's diverticulum)	Not given	Laparotomy and removal of diverticulum	<i>Lancet</i> , 1892, i. 273
G. A. Wright .	Band (passing between two portions of bowel)	10 days	Laparotomy and division of band	<i>Ibid.</i> ii. 144
Southam .	Band (passing from the vicinity of some enlarged glands to mesentery)	10 " (faecal vomiting)	"	<i>Brit. Med. Journ.</i> 1893, ii. 373
Rushton Parker	Strangulation of ileum through an aperture in the mesentery	3 days	Laparotomy and reduction of the hernia	<i>Ibid.</i> p. 1373
Franklin .	Band (composed of lymph formed four days after blow on abdomen)	3 "	Laparotomy and separation of band	<i>Lancet</i> , 1893, ii. 748
Howard Marsh	Band	6 " (faecal vomiting)	Laparotomy and division of band	<i>Ibid.</i> i. 588
Broca .	Band	Not given	"	<i>Ann. Univ. Med. Sci.</i> 1893, iii. C-56
Dean .	Band	Not given	"	<i>Brit. Med. Journ.</i> 1894, i. 752
Hutchinson .	Band (extending from gut to linea alba)	15 hours	"	<i>Ibid.</i>
H. Butcher .	Band (Meckel's diverticulum)	10 days (faecal vomiting)	"	<i>Ibid.</i> p. 1078
"	Band (drawn-out tag of omentum)	3 days	"	<i>Ibid.</i>
Cave .	Band (attached by one end to the back of the abdomen near the left pelvic brim, the other deep in the pelvis)	6 " (faecal vomiting)	"	<i>Ibid.</i> ii. 67
R. Jones .	Band (extending from the direction of the right kidney)	12 days (4 days of faecal vomiting)	"	<i>Ibid.</i>
Koch .	Band	3 days	"	<i>Brit. Med. Journ.</i> Epitome, 1894, i. 18
Dörfler .	Band	2 "	Laparotomy, artificial anus, three days later resection of bowel	<i>Ibid.</i>
Dent .	Band (probably stretched peritoneal adhesion)	3 "	Laparotomy and division of band	<i>Brit. Med. Journ.</i> 1894, i. 118
Thiéry .	Band (fibrous)	Not given	"	<i>Ann. Univ. Med. Sci.</i> 1894, iii. C-23

Table of Successful Operations &amp;c. (continued)

Operator	Nature of Constriction	Time intervening between onset of symptoms and operation	Nature of Operation	Reference
L. Smith . .	Band (attached by one end to the large intestine, by the other to the small)	Not given		<i>Ann. Univ. Med. Sci.</i> 1894, iii. C—24
J. H. Braham .	Band (extending from broad ligament to caecal region)	4 days	Laparotomy and separation of band	<i>Annals of Surgery</i> , 1894, xx. 50
H. Thompson .	Band (extending from one part of mesentery to another)	9 "	Laparotomy and division of band	<i>Lancet</i> , 1894, ii. 382
A. H. Cordier .	Band	Not given		<i>Ibid.</i> 1895, i. 1042
J. Murphy . .	Band	Not given	Resection of 4 inches of bowel, end-to-end anastomosis with Murphy's button	<i>Ibid.</i>
Pick . . . .	Meckel's diverticulum and another band	3 days	Laparotomy	<i>Brit. Med. Journ.</i> 1895, ii. 126. Holmes's tables
Haward . . .	2 or 3 bands	3 "	"	<i>Ibid.</i>
" (2nd case)	Band	3 "	"	<i>Ibid.</i>

Column 2 contains, where stated in the report of the case, the nature of the agent producing the obstruction. In many cases it is definitely stated that it was either not possible or not deemed advisable to prolong the operation in order to search for the exact attachment of the constricting agent, whether a band, an aperture, or hernial fossa.

Column 3 gives the time at which the operation was performed after the onset of the symptoms. The earliest date given is fifteen hours, and the latest twelve days. It is probable that at no period of the disease is the operation forbidden, unless the patient be moribund. Where faecal vomiting was stated in the report to be present at the time of operation, it has been noted; and it is interesting to see in how many cases this advanced symptom existed.

Column 4 indicates the nature of the operation performed. In almost every instance of constriction by a band, this was either simply divided, or ligatured in two places and divided between. In cases where the vermiform appendix or Meckel's diverticulum proved to be the constricting band, care was

taken to close the patent orifice, if such existed. In only one case (Dörfler) was it found necessary to form an artificial anus. Three days later fifteen centimeters of the gut were resected, and the patient recovered. The author states that the bowel had become gangrenous in twenty-eight hours.

The inevitably fatal result which follows in this class of cases when left alone, and the success which has attended surgical intervention, may be taken as ample justification for operation. And, further, the rapidity with which gangrene occurs in cases of a tense constricting band renders early operation imperative.

Laparotomy should be performed in the usual way by a median incision below the umbilicus, the opening being enlarged as required. In many instances the band will give way during the process of manipulation, in other cases it must be divided; and when vascular or formed of some normal structure abnormally attached, care must be taken to efficiently ligature or close the parts.

If the bowel be not gangrenous, the result of relieving the constriction will be to cause it to resume rapidly a more natural appearance, the lividity of its walls giving place to a pinker colorisation, and the distension of the gut above subsiding, while at a not distant period flatus and fæces will pass from the rectum.

Should the bowel be gangrenous, the surgeon must decide from the condition of the patient whether he should adopt the more rapid method of forming an artificial anus, subsequently dealing with the part, or whether he should at once remove the gangrenous portion and form a lateral or end-to-end anastomosis. With Murphy's button less time might be spent in uniting the bowel end to end after removal than in making an artificial anus. In his records of cases in which the button has been used, Murphy<sup>1</sup> quotes two successfully so treated. Failing, however, such a ready means, and the patient's strength appearing unequal to a prolonged operation, the distended part of the gut above should be stitched to the wound, and an artificial anus established.

<sup>1</sup> *Lancet*, 1895, vol. i. p. 1042.

In cases where fæcal vomiting has set in, much relief is obtained by washing out the stomach.

*After treatment.*—In all cases where the bowel has been efficiently liberated, fluid diet may be commenced at once. For the first few days small quantities of opium should be given, and the diet should not be too plentiful. The bowels are likely to act freely. In order to obtain a secure cicatrix in the parietal wound, the patient should not be allowed up for about three weeks.

CASE LXXV.—*Intestinal obstruction due to the occlusion of the ileum by a band: operation. Recovery.*

A girl aged 14 years had for the last four years been subject to what were called bilious attacks, the prominent symptom of which was vomiting, which lasted for one or two days and was often accompanied by pain and sometimes by diarrhœa. For twelve months she had had considerable pain in the epigastrium, which came on directly after taking food, and often resulted in sickness. About two years back she suffered great pain in the right side on exertion, more particularly if she attempted to walk quickly or to run.

On December 7, 1893, while at her work, she was suddenly seized with violent pains shooting across the abdomen in the line of the umbilicus. She vomited several times on her way home, and on her arrival went to bed. The acute symptoms abated somewhat. For two or three days she remained in considerable pain with occasional sickness, when her mother administered a copious soap-and-water enema. This gave temporary relief by emptying the large bowel of gas, but the pain and vomiting returned with renewed severity. On December 13 the patient was in great pain, with moderate distension, good pulse, moist tongue, and normal temperature. On December 15, eight days after the onset, the vomiting became fæcal. On December 19, when first seen by the author, she presented symptoms of collapse—a small quick pulse, dry tongue, haggard look, listless demeanour, and rapid shallow respirations. The abdomen was distended and tympanitic, especially round the middle line. Feculent material was being vomited every few minutes, thirst was intense, and there was pain on pressure over the right side of the abdomen. The patient was mentally alert, and took an intelligent interest in her affairs.

Laparotomy was performed on December 19, twelve days after the onset of symptoms. A band about half an inch broad was found stretching apparently transversely across the gut from the direction of the right kidney. Ligatures were applied and the strand severed. Peritonitis had set in, as evidenced by the adherent condition of the coils. The operation occupied twenty minutes. The patient made an uninterrupted recovery. (Robert Jones, 'Brit. Med. Journ.' 1894, vol. i. p. 1123.)



CASE LXXVI.—*Acute intestinal obstruction produced by Meckel's diverticulum. Death.*

James C., aged 4 years, while enjoying good health, was suddenly seized with acute pain in the abdomen on January 18, 1895. He shortly afterwards vomited, and the pain continuing to increase, his parents gave him some hot brandy and water, and applied hot fomentations to his belly. On January 21—three days after the onset of his symptoms—he was admitted into the Victoria Infirmary. His face was pale, with dark depressions beneath the eyes. He was drowsy, and when roused complained greatly of thirst. Everything taken was vomited. His pulse was full, easily compressible, and about seventy per minute. The abdomen was tumid and swollen, tympanitic in the upper part, but dull and somewhat resistant below. By palpation nothing of the nature of a tumour could be felt, and manipulation of the belly did not cause pain. Rectal examination revealed nothing, but on withdrawal of the finger a little blood was detected upon its apex. The respiration was chiefly thoracic and somewhat laboured. The parents stated that nothing had come by the bowel except some blood which followed the injection of water on the morning of the day of admission.

The diagnosis made was that of probable intussusception, and the collapsed condition, as well as the age of the child, rendered operation inadvisable. The next morning there was faecal vomiting, and in the evening the child died.

*Post mortem.*—The distended coils of intestine were slightly glued together, giving evidence of peritonitis. The whole of the large intestine and about four inches of the ileum at its caecal extremity were collapsed. About twelve inches of the ileum above this were also collapsed, and constituted a loop which had passed beneath a constricting band, comprised of Meckel's diverticulum about an inch and a half in length and a fibrous cord an inch long, extending from its apex and attached to some enlarged mesenteric glands. The remaining part of the ileum and the jejunum were greatly distended, containing a considerable quantity of yellow watery faecal matter. The diverticulum communicated with the ileum by a small orifice; from this point onwards the canal enlarged, and formed a sac somewhat egg-shaped. It had become gangrenous, but no perforation had taken place. The coil of gut which had passed beneath the bridge of diverticulum and band could be easily withdrawn, and did not seem to have been acutely strangulated. (A. Ernest Maylard, Clinical Reports, 1895.)

It is impossible not to feel, in this latter case, that an operation performed within twelve hours of the onset of the symptoms would have been fraught with success. By the simplest manipulation the loop could have been disengaged, and by a very simple extension of the operation the diverticulum and band could have been removed. Had I but known

also the real nature of the obstructing agent, I think I should have been tempted, notwithstanding the age and condition of the child, to have made an exploratory incision shortly after admission.

---

## CHAPTER XLIII

### 2. ADHESIONS. KINKING

THERE is a large class of cases where obstruction of both an acute and chronic character arises from adhesions which do not necessarily form well-defined bands. The function of the bowel in this class of cases becomes impaired by reason either of the altered position it is caused to assume by being dragged up or down or fixed, or by the contraction of adhesions constricting it or causing it to be kinked. In some cases it is only a limited portion of the bowel which is involved, while in others the intestines are extensively matted together.

While the immediate cause of these adhesions is some antecedent local or general peritonitis, they are indirectly the result of inflammation connected with injury or disease. Thus tubercular peritonitis is a fruitful source of extensive general adhesions, while operations which involve opening the peritoneal cavity are more commonly the cause of local matting.

Considerable interest attaches to this latter class, from the frequency with which abdominal operations are now performed. Quite a number of cases have been recorded illustrative of serious obstructive troubles arising from the formation of post-operative adhesions. Lucas-Championnière<sup>1</sup> records five cases where symptoms of obstruction set in a few days after operation. In one the operation was for the removal of an ovarian tumour, in another for the relief of a strangulated hernia, and in three others for the radical cure of hernia. Rohé<sup>2</sup> has collected no fewer than seventy-five deaths from acute intestinal obstruction following upon intraperitoneal operations. He states that obstruction of the

<sup>1</sup> *Revue de Chirurgie*, 1892, p. 264.

<sup>2</sup> *Annals of Surgery*, 1895, vol. xxi. p. 104.

bowel causes between one and two per cent. of the deaths following ovariectomy and other such like operations. Harrison Cripps<sup>1</sup> has published a case where acute obstruction set in eighteen days after the removal of a large multinodular fibroid growing beneath the broad ligament. The adhesions proved so inseparable from the bowel that the damage inflicted upon the latter necessitated the formation of an artificial anus. This was afterwards successfully dealt with by excision, and end-to-end anastomosis effected.

In by far the larger proportion of cases the cause of obstruction is due either to adhesions of coils of intestine to one another, or of these to the abdominal wall or to other viscera. Jones<sup>2</sup> records a case of adhesion at the neck of an old femoral hernia. He also narrates two other cases, one where the adhesions were connected with an old appendicitis, and one where they were found at the posterior wall of the abdomen. Fowler<sup>3</sup> records a case of intestinal obstruction due to adhesions the result of an appendicectomy performed three weeks before; and another, where, as the result of some past intrapelvic inflammation, the small intestines were found bound down by old adhesions in the pelvis and just behind the cæcum. A case similar to this last is recorded by West and Littlewood,<sup>4</sup> where a coil of intestine was bound down to the rectum; the acute obstruction was relieved by separating the adhesions, and the patient recovered. Cave<sup>5</sup> mentions a case where adhesions the result of a healed tubercular peritonitis had led to kinking of the bowel. A somewhat similar case of kinking, the result of a local peritonitis, is recorded by Paul.<sup>6</sup>

**Symptoms.**—Obstructive symptoms may arise in one of two ways, either acutely and suddenly, or slowly with such indications as colicky pains, constipation, occasional vomiting, and other vague feelings of abdominal discomfort. In those cases where the symptoms occur at an interval after an attack of inflammation connected with some internal viscus or with peritonitis, local or general, some clue is obtained as to the

<sup>1</sup> *Brit. Med. Journ.* 1894, vol. ii. p. 1103.

<sup>2</sup> *Lancet*, 1891, vol. i. p. 1370.

<sup>3</sup> *Annals of Surgery*, 1894, vol. xix. pp. 165, 359.

<sup>4</sup> *Brit. Med. Journ.* 1896, vol. i. p. 1330.

<sup>5</sup> *Ibid.* 1894, vol. ii. p. 67.

<sup>6</sup> *Lancet*, 1894, vol. i. p. 609.

possible cause of the obstruction ; but in many of the post-operative cases, more particularly in those occurring within a comparatively short time of the operation, the symptoms may be marked by pain, vomiting, and tympanites, results as much likely to be due to the operation itself as to any intestinal mischief directly dependent upon it.

It is more usual, however, for an interval of some days to elapse before any obstructive symptoms manifest themselves. In any case, therefore, where a patient is suddenly seized with acute pain accompanied with obstinate vomiting, symptoms which show no sign of abatement, and to which are added some tympanites and inability to pass fæces and flatus, suspicions should be entertained that the bowel has become obstructed in some way by adhesions.

In cases of obstruction occurring only a few days after operation, the adhesions are usually soft, of the nature of lymph, and easily detached.

**Treatment.**—From the nature of the obstructing agent, nothing but operation can be of any avail. When taken sufficiently early, before the patient begins to show any serious constitutional symptoms, success may be reasonably expected after laparotomy and separation of the adhesions. The cases above alluded to, recorded by Lucas-Championnière, Jones, Cave, and Paul, were all successful.

When symptoms of obstruction manifest themselves after ovariectomy or other intraperitoneal operations, no delay should be exercised in reopening the wound or, if deemed advisable, employing a fresh incision. When the adhesions cannot be separated without serious injury to the bowel, it will be necessary to remove the involved portion, or perform lateral anastomosis where the coils are free. Murphy<sup>1</sup> quotes four cases where one or other of these measures was successfully carried out. In a case of my own, the vermiform appendix had such firm adhesions to the neighbouring part of the ileum that in endeavouring to sever them I tore the bowel and was obliged to excise about three inches. The parts were joined by end-to-end anastomosis, and the patient made an uninterrupted recovery. A similar accident happened in Cripps's case already quoted; the treatment,

<sup>1</sup> *Lancet*, 1895, vol. i. p. 1042.

however, differed in this respect, that in the latter case an artificial anus was first established, and subsequently excision was performed.

CASE LXXVII.—*Acute intestinal obstruction from constricting adhesions the result of repeated attacks of appendicitis.*

A man aged 35 years had suffered from attacks of peritonitis for some years. Thirteen days before the operation he was seized with sudden acute griping pain in the abdomen, the attack lasting about an hour and then passing off. Similar attacks occurred at varying but frequent intervals, the bowels being, however, open, though imperfectly. Thirty-six hours before the operation he took a dose of castor oil, which set up intense pain, and was followed by complete obstruction, and about twenty hours afterwards by extreme collapse. About thirty hours after the castor oil he had fæcal vomiting, and when put on the table he was practically moribund and his pulse could not be felt.

The abdomen was opened, the appendix which encircled the ileo-cæcal valve removed, and the adhesion cut and torn through till the contents of the small intestine could be readily squeezed into the large. The patient lay in an almost pulseless condition for thirty hours after the operation, without vomiting, however, and without any marked pain, and then he had two copious and very offensive stools. After that he was very collapsed, but soon recovered, and when seen thirty-six hours after the operation his pulse had greatly improved. His subsequent recovery was uninterrupted. (Watson Cheyne, 'Brit. Med. Journ.' 1894, vol. i. p. 967.)

---

## CHAPTER XLIV

### 3. INTUSSUSCEPTION

THE passage of one segment of the bowel into another may take place at any point, implicating either the small intestine alone, or the small and the large together, or only the large. By far the largest number of cases are those where both large and small are involved.

It is usual to classify these various kinds of intussusception into *enteric*, *ileo-cæcal*, *ileo-colic*, *colic*, and *rectal*. Only the first three will be described here, the latter being discussed under Affections of the Large Bowel.

In order of frequency the ileo-cæcal stands first, the ileo-colic is least often met with, and the enteric occupies an intermediate position.

Obstruction from intussusception is much more common during the early years of life. At this period it is usually of the acute and complete form, but when occurring in later years, it is often chronic and incomplete.

**Pathological anatomy.**—The form of intussusception which gives rise to obstruction during life, as contrasted with that which is so frequently found after death, and which is probably produced immediately prior to the extinction of life, is almost without exception single, and the result of an upper section of the bowel passing into the section immediately below.

In the *ileo-cæcal* variety a prolapse of the ileo-cæcal valve takes place into the cæcum, and to whatever extent the invagination proceeds, the valve always forms the apex or presenting part.

In the *enteric* variety a portion of the small intestine slips into a section of the same immediately below. This may occur in any part of the jejunum or the ileum.

In the *ileo-colic* the ileum, at its lower part, first passes into a section of its own immediately below, and then proceeding, passes through the ileo-cæcal valve into the cæcum and colon, so that the apex or presenting part is always a part of the ileum. When this variety extends for any distance down the colon, it is frequently at the expense of the cæcum and ascending colon.

If a transverse section be carried through a simple intussusception, it will be found that between the central lumen of the bowel and the exterior there are three layers of gut wall. The external one is termed the *sheath* or *intussuscipiens*, the internal the *entering layer*, and the middle the *returning layer*. The two latter combined constitute the *intussusceptum* (see fig. 51). It will therefore be seen that the opposing surfaces of the external and middle layers are formed by the mucous lining of the bowel, while the opposing surfaces of the middle and internal are formed by the serous or peritoneal coat. Between these two latter exists the mesentery. The presenting part of the intussusceptum is called the *apex*, while the point of junction of the intussusceptum with the intussuscipiens constitutes the *neck*. A reference to the accompanying diagram will show the parts designated.

In some rarer instances the intussusception is double,

and still more rare is the occurrence of the triple variety. In the case of the double kind, a transverse section would reveal two extra layers, that is to say, five in place of three; while in the triple form there would be seven layers.

In length the enteric form is usually shorter than the others. All increase in length is at the expense of the sheath or intussusciptens, except in the case of the ileo-colic, where for the earlier stage of its course it is the entering layer which continues to pass in. The length of the intussusception is probably determined by the length of the mesentery and the quantity of fat it contains. A congenitally short mesentery or one which contains much fat will materially impede any very extensive process of invagination.

While the mesentery has to some extent an inhibitory effect upon the progress of the intussusceptum, it has also the effect of altering its course and causing pressure upon the neck. Attached to one side only of the bowel, it draws upon that side and more particularly upon the apex. Hence the lumen of the latter is made to look to one side, and the mesenteric border assumes a concavity with a corresponding convexity on the opposite aspect. Further, this traction, as the invagination increases, renders the intussusceptum liable to become twisted within the sheath.

If the mesentery were removed from the intussusceptum, divided at the neck, and spread out, it would be found to be triangular in shape; the apex of the triangle would represent the part at the apex of the intussusceptum, while the base would correspond to its neck. Hence it will be observed that

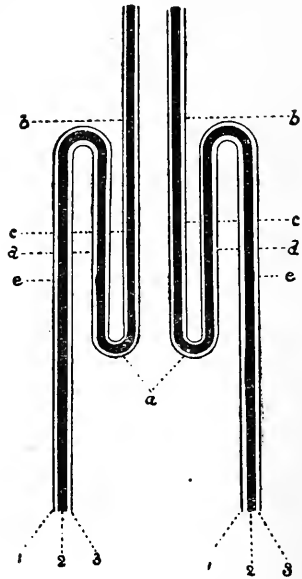

FIG. 51.—DIAGRAM OF LONGITUDINAL SECTION OF AN INTUSSUSCEPTION

1, peritoneum; 2, muscle coat; 3, mucous membrane; *a*, apex of intussusceptum; *b*, neck of intussusception; *c*, entering layer; *d*, returning layer; *c* and *d* combined form the intussusceptum; *e*, sheath or intussusciptens

much more is contained within the sheath at the proximal end of the intussusception than at the distal. The effect of this and the other points given above upon the causation of acute obstruction will now be described.

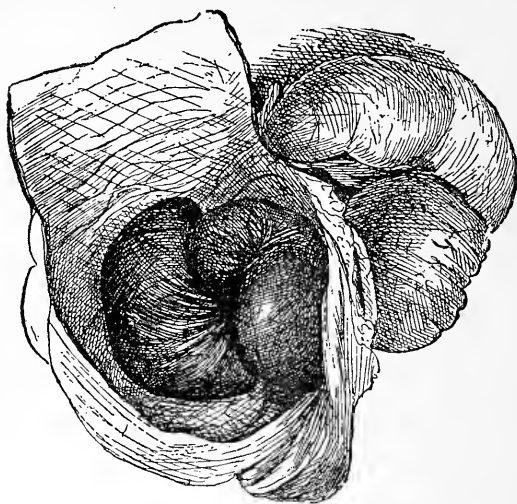

FIG. 53.—ILEO-CÆCAL INTUSSUSCEPTION (Coats)

The colon is laid open and several coils of ileum are shown which have protruded through the ileo-caecal valve. One of the coils was gangrenous.

**The indirect and direct causes of obstruction.**—In discussing the various causes which bring about intestinal obstruction connected with intussusception, it is found that they group themselves under two more or less distinct heads. First, there are those which are remote or indirect in their effect, and, second, those which are immediate or direct.

*Indirect or remote.*—These causes are connected with the primary formation of the intussusception. While in many cases it does not seem possible to fix upon any particular agent as the initial incentive to invagination, there are not a few in which it is traceable either to mechanical obstruction within the bowel or to the effect of some irregular innervation of the involuntary muscle tissue forming one of its coats.

The commonest form of an obstructive cause is found in tumours, such as polypi, attached to the mucous membrane. They usually appear at the apex of the intussusceptum, and



thus suggest the probable action they take in starting an invagination by suddenly dragging in a section of the intestinal wall. The fact, however, that polypi are not constant in this position militates against so simple a mechanical view. Lockwood<sup>1</sup> reports a case where the polypus was situated above the apex.

Another form of obstruction is possibly to be found in the constricted orifice of the ileo-cæcal valve, which, under certain conditions of the contents of the ileum, may be prolapsed into the cæcum.

That irregular innervation of the muscular coat plays a not unimportant part in causing intussusception appears likely from the experiments performed by Nothnagel on rabbits, quoted by Treves.<sup>2</sup> These experiments went to show that a localised stimulation of the bowel by electricity brought about a contraction which ended in the formation of an intussusception. It is not difficult to take a step further in a clinical direction and assume that certain stimulants lead to a similar localised contraction, with resulting invagination. Whether these stimulants act from a distance through the nervous system, or more directly upon the mucous membrane of the bowel, it may not be always easy to determine. But from the clinical history often obtainable it would seem that in not a few cases gastro-intestinal disturbances have been caused by the ingestion of such irritants as unripe fruit and other indigestible substances.

The fact that in many cases the patients are out of health or debilitated would point to the possibility of there being some want of tone in the muscle tunic, and consequently imperfect innervation and irregular peristaltic action. When once the invagination has taken place, its further progress is probably brought about by the bowel above tending to force it on.

*The direct or immediate cause of obstruction.*—The invagination of any portion of the bowel does not necessarily give rise to obstruction at once. The lumen of the internal cylinder may remain sufficiently patent to admit of the bowel contents passing; it is only when from some cause this cylinder becomes partially or completely occluded that symptoms

<sup>1</sup> *Trans. Path. Soc. Lond.* 1892, vol. xliii. p. 74.

<sup>2</sup> Page 204.

of obstruction become manifest. It will thus be seen that three conditions are possible : one, where no obvious obstruction exists ; two, where it is partial ; and three, complete.

The changes which take place in the part, and which are now to be described, will serve to more fully explain these conditions, as well as afford elucidation of the difficulties which the surgeon has to encounter in his treatment of them.

Immediately an intussusception is formed, pressure commences to be brought to bear upon the base of the triangular-shaped piece of mesentery at the neck of the tumour. Inasmuch as this contains both the arteries and the veins of the intussusceptum, the effect of the pressure is first to obstruct the veins, and hence impede the return of blood from the part. Should this pressure only be slight, no further changes of an acute character need take place ; and, failing any natural reduction, the remoter processes may consist in some organic union of the parts so that no further obstruction occurs. In some cases the intussusceptum will be gradually cast off, either entire or in irregular shreddy pieces.

Assuming, however, that the effect of pressure on the veins is sufficient to lead to further and more serious changes, it will be found that these changes consist in a gradual engorgement of the coats of the intussusceptum. The part to be first affected will be the apex, then the middle layer, mostly on its convex aspect, and lastly the mesentery itself. The combined effect of these two latter influences will be to produce pressure at the neck sufficient to obstruct the arteries. Hence, with the blood supply entirely cut off, gangrene of the intussusceptum will follow. The engorgement of the coats, besides leading to external œdema and consequent swelling, causes rupture so that blood escapes into the bowel beyond. Another result of this venous congestion or of later ulceration is the occasional formation of adhesions between the internal and middle layers—that is, between the two opposed serous surfaces. The changes effected in the sheath or intussuscipiens are usually slight ; when much pressure is brought to bear upon its mucous lining owing to the size of the intussusceptum, some ulceration and even sloughing may result.

Considering the changes thus brought about, together

PLATE XVII.

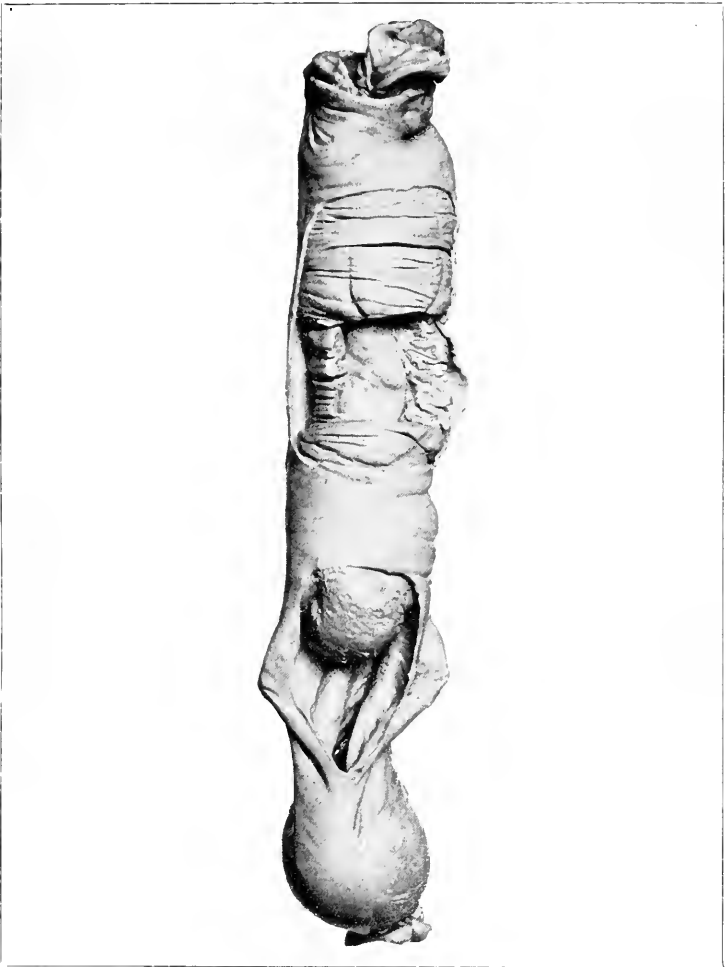

Fig. 52.—ILEO-CÆCAL INTUSSUSCEPTION.—The apex of the intussusceptum is seen through the aperture below. Above, the sheath, or intussusciens, is cut away to show the two layers—the entering and returning—of the intussusceptum. (*R.I.M., Glas.*)



with the part played by the mesentery in its traction upon the bowel, it is not difficult to understand how complete obstruction is effected. The block may exist either at the neck, in the body, or at the apex of the intussusceptum. When occurring at the neck, it is due to the pressure exercised by the mass of mesentery which has been dragged in, plus the engorgement of the middle cylinder from venous congestion. When the block occurs in the body of the intussusceptum, it is from torsion of the part, effected by the mesenteric attachment; and when occurring at the apex, it may be due to the occluding effect of greater engorgement of this part, together with the tilted and narrowed orifice effected again by traction of the mesentery. It will thus be seen that, at whatever point obstruction takes place, the principal agent in producing it is the mesentery.

Obstruction, however, may be brought about suddenly in cases where the changes above described are not in themselves acute. Three cases have been recorded where it was found that the internal cylinder had become obstructed by some indigestible material which, while capable of passing quite easily through the normal canal, could not get transmitted through the reduced lumen of the intussusceptum.

There are certain points of practical surgical interest in connection with these changes which are worthy of note.

First as regards the formation of adhesions between the middle or returning layer and the entering layer. Whatever may be their actual cause, there are considerable difficulties as regards their date of appearance, when reckoned from the onset of the symptoms. Thus, in a case recorded by Marsh,<sup>1</sup> laparotomy was performed fifteen hours after the onset of symptoms, and yet in this comparatively short time adhesions had formed so firmly between the opposing serous layers that reduction was impossible. Makins<sup>2</sup> also records a case where, at the post mortem, tight adhesions existed, although death occurred forty-eight hours after the onset of symptoms. On the other hand, Baur,<sup>3</sup> in an exhaustive discussion upon the subject, states that adhesions may not take place for

<sup>1</sup> *Lancet*, 1891, vol. i. p. 368.

<sup>2</sup> *Trans. Clin. Soc. Lond.* 1889, vol. xxii. p. 282.

<sup>3</sup> *Berliner klin. Wochenschrift*, 1892, p. 879.

months. Carver<sup>1</sup> successfully reduced an intussusception after laparotomy in the case of a boy whose symptoms had dated back seven weeks. For twenty-five days prior to operation it is stated that he suffered from stercoraceous vomiting.

Another point of practical interest is the death and discharge of the intussusceptum. In cases which run either



FIG. 54.—INTUSSUSCEPTION (O'Connor)

length of ileum measuring  $11\frac{1}{2}$  inches in length with Meckel's diverticulum; passed *per rectum*.

an acute or chronic course, the intussusceptum may become gangrenous; separation of the dead parts will then commence. This may consist in the discharge of considerable segments of the bowel or of disintegrated shreds. Death of the patient usually takes place in acute cases before separation of any

<sup>1</sup> *Lancet*, 1889, vol. i. p. 171.

part of the bowel is possible. Eccles,<sup>1</sup> however, reports a case of spontaneous separation of gut in an infant 3 months old. The patient had had symptoms for sixteen days, and the bowel protruded from the anus. Recovery ensued. In subacute or chronic cases considerable-sized sloughs of mucous membrane are sometimes passed *per rectum*. In a case of acute intussusception reported by O'Connor,<sup>2</sup> eleven and a quarter inches of the ileum with a Meckel's diverticulum attached were cast off and ejected by the rectum eight days after the onset of the symptoms (see fig. 54). The boy was aged 13 years and made a good recovery. In another case, recorded by Pullin,<sup>3</sup> a patient aged 79 years, after thirteen days of more or less acute symptoms of obstruction, passed *per anum* a sloughy mass of intestine, measuring, as far as could be made out, about two inches. Whether the slough was from the large or small intestine is not stated; quite likely it was not possible to determine from what region it had come. The patient made a speedy and complete recovery.

Short of gangrene, the extreme distension of the apex and wall of the intussusceptum often causes fissures in the engorged parts.

**Symptoms.**—As a class of cases of intestinal obstruction, none presents symptoms which frequently so definitely indicate the true cause. In the greater proportion of the acute cases it is possible to arrive at a correct diagnosis.

In addition to the usual symptoms of acute intestinal obstruction already described under Obstruction from Bands, the existence of a sausage-shaped abdominal tumour situated in the left lumbar or iliac region, tenesmus with the passage of blood and mucus from the bowel, and the presence of a tumour to be felt *per rectum*, prove a case to be one of unmistakable intussusception.

The symptoms, however, are frequently not so typical. In a case reported by Makins,<sup>4</sup> there was neither tenesmus nor passage of blood and mucus. The child died in forty-eight hours, when an enteric intussusception was discovered situated

<sup>1</sup> *St. Bartholomew's Hospital Reports*, 1892, p. 97.

<sup>2</sup> *Brit. Med. Journ.* 1894, vol. ii. p. 123.

<sup>3</sup> *Ibid.* 1896, vol. i. p. 82.

<sup>4</sup> *Trans. Clin. Soc. Lond.* 1889, vol. xxii. p. 282.

about a foot above the ileo-cæcal valve. Abbe<sup>1</sup> reports a still more striking instance of what might be termed an abnormal cause of the disease. A lady was suddenly seized with pain in her abdomen below the umbilicus, and slight sensations of faintness and nausea. The symptoms during the week prior to operation were very scant, no tenesmus, no mucus and bloody stools, nausea and vomiting only occasionally present, and temperature normal. No tumour could be felt. On the sixth day the vomit became feculent. At the operation, the intussusception was found eight feet from the ileo-cæcal valve. The patient died.

A closer examination of the symptoms reveals the fact that in the majority of instances they are materially affected by the situation of the intussusception and the completeness of the obstruction. In both the enteric and ileo-colic varieties the tumour is usually small, and in the former may be so buried in the abdominal cavity among other coils that it cannot be felt. Further, in both varieties tenesmus is an unlikely symptom; and the presence of bloody mucus, even suppose blood be thrown out from the intussusceptum, is not likely to be recognised, should such be passed *per rectum*.

The two symptoms, tenesmus and the passage of blood and mucus, are met with most prominently in cases where the intussusceptum has descended into the sigmoid flexure or rectum. Here the sense to the patient of something distending the lower bowel evokes persistent efforts for its expulsion; and the nearness of the tumour to the anus allows of the unaltered blood being recognised.

The completeness of the obstruction determines the mode of onset and the character and persistency of the pain and vomiting. When the bowel is completely, or almost completely, obstructed at the outset, the seizure is sudden, the pain is acute, and vomiting soon sets in and persists. On the other hand, if not complete, the pain, at first slight, becomes paroxysmal in character; vomiting is infrequent, but increases, like the other symptoms, as the lumen of the bowel becomes closed.

It is unusual to meet with either tenderness or distension of the abdomen; when they do appear they indicate commencing peritonitis.

<sup>1</sup> *New York Med. Journ.* 1891, vol. liv. p. 639.



The ileo-cæcal variety gives rise to the most marked kind of tumour. It is situated usually in the left lumbar and iliac regions, and conveys to the touch a swelling the shape and consistency of a sausage. During paroxysms of pain it becomes much harder and more prominent. It is always best felt after the abdominal parietes have been completely relaxed by the administration of an anæsthetic. When the tumour descends sufficiently low to be felt by the finger in the rectum, it is said to feel like the cervix uteri. In some cases the intussusceptum passes through the sphincter, so as to project externally; and in some cases, where it does not descend to the extent of extrusion, it frequently causes a patulous condition of the anus.

Incompleteness of obstruction gives rise to the two clinical classes of subacute and chronic cases, the symptoms of which are frequently so vague that they are more than likely to be ascribed to some cause other than the true one.

Patients suffering from subacute or chronic intussusception are liable to be attacked by pain of a periodical and colicky character, accompanied with vomiting and sometimes tenesmus. In the most chronic cases, peristaltic action of the intestines can be observed through the thinned parietes. Inasmuch as the ileo-cæcal variety is the one most frequently found in these cases, it is often possible to detect a tumour in the left iliac region. It occasionally happens that complete obstruction takes place, when all the symptoms become acute. Failing any such untoward accident, relief may come through a spontaneous separation of the intussusceptum; or the patient will continue to emaciate, and die eventually from progressive exhaustion.

In some cases the progress of a natural cure is suddenly terminated by the onset of acute symptoms indicative of perforation. The patient is seized with acute abdominal pains, becomes collapsed, vomits, and the abdomen soon distends and becomes tender on palpation. The clinical significance of these symptoms is commencing peritonitis, and their explanation perforation of the bowel along the neck of the intussusception. Either ulceration has progressed until a complete communication has become established between the general peritoneal cavity and the interior of the bowel, or the adhesion

of the entering to the returning layer has been insufficient to stand the strain placed upon it on separation of the intussusceptum.

CASE LXXVIII.—*Ileo-cæcal intussusception: laparotomy. Reduction.*

W. S., aged 10 years, a healthy lad, was suddenly seized on the evening of March 4 with severe pains in the abdomen. On the following morning, March 5, at 5 A.M., he commenced to vomit. On March 6 he was admitted into the Tyrone County Infirmary, when his condition was as follows: His eyes appeared very dull, heavy and sunken; face pale and pinched; his countenance was expressive of great distress; his lips pale; tongue small, dry, and brown; teeth slightly coated with sordes. He lay on his back with his knees drawn up, complained of great pain in the abdomen, particularly intense in the right iliac region, where a more or less sausage-shaped tumour could be distinctly made out, shifting its position slightly at intervals. Dulness existed in both flanks, with slight tympany in the central region of the abdomen. Tenesmus was constant, but since admission he had passed no blood, mucus, or flatus. His parents refusing operation, conservative measures were tried till March 8, when his symptoms became more urgent. He had constant hiccough, with retching and constant vomiting of dark fluid material. Tenesmus still present, and great thirst. Breathing was very rapid and shallow; pulse rapid and thready; torpor had much increased, and when roused he could only speak in a whisper. The abdomen was much more swollen and tympanitic, the feet and legs cold and clammy; the temperature, which had run up to 100° 8', was subnormal.

Laparotomy performed four days after the onset of the attack. On opening the abdomen a considerable quantity of dark-coloured pus oozed out. The coils of the small intestine were so enormously distended with gas that they tended to escape like balloons. An invagination of about six inches of the ileum through the ileo-cæcal valve was found. With some little difficulty the intussusceptum was withdrawn. The abdominal cavity was cleansed and drained. The boy made an uninterrupted recovery. (R. E. Thompson, 'Brit. Med. Journ.' 1891, vol. ii. p. 750.)

## CHAPTER XLV

### INTUSSUSCEPTION (*continued*). TREATMENT

WHILE the course to be adopted in the treatment of any case of intussusception must always be considered solely upon the conditions present at the time, still it will simplify the discussion of the subject if some sort of a clinical classification be attempted as an approximate basis for the pursuit of any particular line of treatment.

Cases may be divided into

- I. Acute seen within forty-eight hours.
- II. Acute not seen till after forty-eight hours.
- III. Subacute.
- IV. Chronic.

**I. Acute cases seen within forty-eight hours.**—There is always some hope that in cases thus early seen reduction may be effected without laparotomy. One of three measures may be practised, *abdominal taxis*, *inflation*, or *injection*. In every case chloroform should be administered.

*Abdominal taxis.*—This method, advocated by Jonathan Hutchinson for all early cases of acute obstruction, has not been practised to any very great extent for intussusception. It is, however, a reasonable measure, and worthy of trial for this class of case. For its mode of performance see Operations upon the Intestines.

*Inflation.*—Distension of the rectum and colon by the forcible introduction of gas has produced successful results. Cheadle<sup>1</sup> succeeded in the case of a baby aged 14 months. It had had symptoms for six days. In three other cases reported by the same author,<sup>2</sup> success also followed inflation. The symptoms in these cases had lasted respectively twenty-four hours, ten and a half days, and seven days. Williams<sup>3</sup> succeeded where the symptoms had lasted for twenty-four hours. He generated carbonic acid in the bowel, by placing in the rectum some carbonate of soda and citric acid.

CASE LXXIX.—*Intussusception. Successful reduction by inflation.*

A boy aged 14 months was admitted into hospital with typical symptoms of intussusception, which had already lasted six days. The operation, which was performed under chloroform, was thus carried out: 'An ordinary Higginson's syringe was used, and the bowel was inflated with air until the abdomen became decidedly tense. After waiting a minute or so, the air was allowed to escape, and on examination the tumour could still be felt in the left hypochondrium. After repeating the inflation, only an ill-defined mass could be made out to the right of the umbilicus; and after a third inflation no tumour could be felt in any part of the abdomen. The child was ordered one minim of liquor opii sedativus every three hours. He became easier after the operation, the pulse improved, and

<sup>1</sup> *Lancet*, 1889, vol. i. p. 171.

<sup>2</sup> *Ibid.* 1886, vol. ii. p. 766.

<sup>3</sup> *Ibid.* 1894, vol. i. p. 537.

two liquid motions were passed within two hours after the inflation, unaccompanied by blood. He vomited once, immediately upon being put under chloroform, but had not done so since.' (Cheadle, 'Lancet,' 1889, vol. i. p. 171.)

For instructions regarding the performance of inflation see Operations upon the Intestine.

*Injection.*—Distension of the bowel from below with water, has, judging by statistics, been more frequently adopted than distension by inflation. Eccles<sup>1</sup> gives three cases which had been successfully so treated at St. Bartholomew's Hospital between the years 1880 and 1891. Pye-Smith<sup>2</sup> succeeded in the case of a boy aged 14 months, who had symptoms for six days. Pollard,<sup>3</sup> after three separate injections in the same case, reduced an intussusception of ten hours' duration; and Bruce Clarke<sup>4</sup> one of nine days.

Both methods of inflation and injection are, however, not void of danger. Knaggs<sup>5</sup> illustrates by eight fatal cases some of these dangers. In seven rupture occurred. In six of these the ages were from 5 to 7 months. In one, only nine ounces of water were injected, 'when a rumbling noise was heard in the abdomen.' In the eighth case the child became collapsed and convulsed immediately before death.

Failing in any reasonable attempt by one or more of these methods to reduce the bowel, laparotomy should be performed without delay.

CASE LXXX.—*Intussusception treated by injection: rupture. Death.*

The baby was aged 3 months. About a pint of fluid was slowly and carefully injected. Suddenly the abdomen became more tense, and it was evident that perforation of the bowel had occurred. The breathing became laboured and slower, and the heart's action almost imperceptible. The child died within an hour. At the post mortem, a small rent was found at a point corresponding with the lowest part of the intussusception. A small quantity of the enema fluid had escaped into the peritoneal cavity. (Parker, 'Trans. Clin. Soc. Lond.' 1892, vol. xxi. p. 244.)

II. **Acute cases not seen till after forty-eight hours.**—Considerable difference of opinion still exists among surgeons

<sup>1</sup> *St. Bartholomew's Hospital Reports*, 1892, p. 97.

<sup>2</sup> *Lancet*, 1892, vol. ii. p. 1441.

<sup>3</sup> *Ibid.* p. 880.

<sup>4</sup> *St. Bartholomew's Hospital Reports*, 1892, vol. xxviii. p. 115.

<sup>5</sup> *Lancet*, 1887, vol. i. p. 1125.

regarding the proper procedure to adopt when a case is not seen till after the symptoms have lasted for a couple of days. With the facilities and needful precautions which exist in a hospital, most surgeons would probably advocate immediate laparotomy; but, under less favourable circumstances and surroundings, should time be spent in trying the more conservative measures above described— taxis, inflation, or injection? It is not possible to lay down any definite rule in the latter case, for not only is there the question of time to be considered, but the condition of the patient. Acute symptoms may have existed for three, four, or more days, and the patient still not be profoundly ill. It would therefore seem quite justifiable under such circumstances to run whatever risk there might exist and attempt conservative measures, especially also in the light of the success which has attended, as shown above, in cases of six, seven, and nine days' duration of symptoms. Failing, however, success by injection or inflation, no further delay should be allowed, and laparotomy at once proceeded with. As an illustration of successful reduction after laparotomy, see Case LXXVIII., p. 382.

The performance of laparotomy for acute cases of intussusception must be looked upon as a serious operation in the case of children. What, however, it has to be contrasted with, is the almost inevitably fatal result to be expected if the abdomen be not opened. The table subjoined will at least lend considerable encouragement to the practice, for every success must be reckoned as a life saved.

*Table of Successful Cases of Laparotomy for Intussusception  
from 1891 to 1895 inclusive*

Operator	Variety of Intussusception	Time intervening between onset of symptoms and operation	Nature of Operation	Reference
Lange . . .		Not given	Laparotomy and reduction	<i>New York Journ. Med.</i> liii. 374 1891, <i>Ibid.</i> p. 434
McBurney . .	Enteric (2 feet above the ileo-cæcal valve)	3 days	"	<i>Brit. Med. Journ.</i> 1891 ii. 750
R. E. Thompson .		4 "	"	<i>Lancet</i> , 1891, i. 368
Howard Marsh .		20 hours	"	<i>Glasgow Med. Journ.</i> 1892, xxxvii. 276
Wm. MacEwen .	Ileo-colic	Not given	"	

Table of Successful Cases of Laparotomy &amp;c. (continued)

Operator	Variety of Intussusception	Time intervening between onset of symptoms and operation	Nature of Operation	Reference
Lindemann .		5 days	Laparotomy and reduction, in addition union of a gangrenous patch to parietal wound	<i>Berl. klin. Wochen.</i> 1892, xxix. 651
Shepherd . .		60 hours	Laparotomy and reduction	<i>Lancet</i> , 1892, ii. 1155
Bruce Clarke .		14 "	"	<i>St. Bart.'s Hosp. Reports</i> , 1892, xxviii. 115
Verral . . .	Ileo-cæcal	12 "	"	<i>Brit. Med. Journ.</i> 1893, ii. 1375
Körte . . .		Not given	"	<i>Ann. Univ. Med. Sci.</i> 1893, iii. C-51
Lockwood . .	Ileo-colic	28 hours	"	<i>Lancet</i> , 1893, i. 1303
Cotterell . .		Not given	"	<i>Brit. Med. Journ.</i> 1894, i. 893
R. Godlee . .	Ileo-cæcal	26½ hours	"	<i>Ibid.</i> p. 347
A. E. Barker .	Enteric	36 "	"	<i>Ibid.</i>
Ochener . . .		Not given	"	<i>Ann. Univ. Med. Sci.</i> 1894, iii. C-29
J. L. Stretton .		2 days	"	<i>Lancet</i> , 1894, ii. 797
A. E. Barker .	Ileo-cæcal	2 "	"	<i>Brit. Med. Journ.</i> 1894, ii. 1237
" (2nd case)	Ileo-cæcal (child aged 4 months)	2 "	"	<i>Ibid.</i>
W. Meyer . . .	Double: primary enteric, secondary ileo-cæcal	8 "	Laparotomy; reduction first of primary, then of secondary. Tumour, involving excision 1½ inch of ileum	Private letter to author
G. W. Ridley .	Ileo-cæcal (aged 11 months)	41 hours after supposed reduction by inflation	Laparotomy	<i>Brit. Med. Journ.</i> 1894, i. 911
Banks . . . .	Enteric (ileum) (boy aged 7 years)	6 days	Resection of gangrenous bowel, end-to-end anastomosis—Murphy's button	<i>Lancet</i> , 1895, i. 487
E. W. Roughton.	Ileo-cæcal	2 "	Laparotomy and reduction	<i>Ibid.</i> p. 483
T. P. Pick . .	Ileo-cæcal	2 "	"	<i>Ibid.</i> p. 745
J. Crawford Renton	Ileo-cæcal	A few hours	"	<i>Trans. Path. and Clin. Soc. Glasg.</i> 1895, v. 177
Fred. Eve (11 months old)	Ileo-cæcal	" "	"	<i>Brit. Med. Journ.</i> 1895, ii. 968

Column 2 contains the kind of intussusception present when stated in the report.

Column 3 contains the interval of time which elapsed between the onset of the symptoms and the performance of

the operation. Unfortunately it has not been found possible to obtain this in every case. From those given, however, it will be seen that the time varied between twelve hours and eight days.

Column 4 contains the nature of the operation performed. It will be observed that in every instance except two the operation consisted in the reduction of the bowel by manipulation. The exceptional cases were those of Lindemann and Banks, where, after reduction, the former operator thought it advisable to stitch a part of the bowel which had become gangrenous to the parietes, and the latter to excise the part. A study of this table of successful cases after laparotomy seems to show that success almost entirely depends upon the possibility of reducing the bowel. If after opening the abdomen reduction proves impossible, then unfortunately there are only two cases recorded—those of Lindemann and Banks—to show that any additional measure which has been practised has proved successful. On the other hand, there are not a few cases reported to demonstrate the lamentable fact that the formation of an artificial anus or the resection of the intussusception has proved of no avail. In 1888 A. E. Barker<sup>1</sup> published statistics of operations for intussusception. Up to that date he found recorded nine recoveries. In every instance the bowel was simply withdrawn. In no case does there appear to have been a successful result after excision or the formation of an artificial anus with or without opening the abdomen. The longest interval between the onset of symptoms and the performance of operation was eighteen days.

The question, however, in spite of these discouraging facts, is, What under the circumstances ought the surgeon to do when he finds that by no manipulative power can he push back or withdraw the intussusceptum? Ought he to close the abdomen and trust to nature's spontaneous efforts at separation of the part; or ought he to proceed to perform one of those various operations which have already been attempted, although with almost no success? To trust to nature is practically to abandon the case to death; but to adopt measures which are known under other circumstances to have been successful is to act where there is some just reason for

<sup>1</sup> *Lancet*, 1888, vol. ii. p. 262.

hoping that life may be saved. As no one method can claim any particular success in the class of cases under discussion, there is little use in placing before the reader one operation more prominently than another. Time is always a serious item; and the condition of the patient may determine the method to be selected.

A fæcal fistula can be formed by bringing a loop of the distended bowel above, to the abdominal incision and securing it there; or the median incision can be closed and a loop of bowel brought out in the loin; or an artificial anus can be produced by dividing the bowel above the intussusception, closing the distal end and bringing the proximal out. A lateral anastomosis may be performed between the distended bowel above and the collapsed portion below. Lastly, the part can be excised, and an end-to-end or lateral anastomosis effected either by Murphy's button or by some other method.

III. **Subacute cases.**—When the symptoms are not urgent, or, if acute at first, shortly subside, subsequently undergoing exacerbations, careful and repeated endeavours to reduce the bowel by taxis, inflation, or injection should be made without delay. Any very obvious and lasting increase in severity, however, of the symptoms should at once determine operative intervention, and all that has been said above in the case of acute cases becomes applicable here.

If the administration of opium is admitted as a suitable drug in any case of intestinal obstruction, then its use in this particular class appears particularly advisable. Anything which will quiet the peristaltic action of the bowel is likely to prevent the onset of more acute mischief at the seat of disease. Where therefore no marked urgency exists, and delay seems advisable, some solid opium and belladonna may be administered by the mouth. Further, the stomach may, with advantage, be washed out, and all food should be withheld from the mouth, nourishment being introduced in the form of enemata.

CASE LXXXI.—*Subacute intussusception: seven weeks' duration: laparotomy: reduction. Recovery.*

A child aged 2 years and 9 months was seized with somewhat acute symptoms, consisting of violent abdominal pain over the right iliac region, and vomiting. He remained ill for three days, when a round worm was



passed, and his bowels opened for the first time, although only a thin yellowish motion with a little blood came away. After ten days the pain subsided and he had two soft motions and was able to retain a little beef tea. He continued in this improved state for about a fortnight, when the pain and vomiting returned more severely than before. The vomiting now commenced to be stercoraceous, and the bowels acting frequently, only brought forth blood and mucus. When admitted, seven weeks after the onset of the symptoms and twenty-five days after the commencement of stercoraceous vomiting, he was extremely emaciated; the abdomen was slightly and uniformly distended. Laparotomy was performed, and with some little difficulty the intussusceptum was withdrawn. (Carver, 'Lancet,' 1889, vol. i. p. 171.)

IV. **Chronic cases.**—The treatment of chronic cases consists either in a careful regulation of the bowels, whereby an effort is made to prevent anything like accumulation taking place above the narrowed part; or in relief by operation. Two cases of successful excision have been recorded, one by Rosenthal<sup>1</sup> and one by Lauenstein. In the latter instance a man aged 56 years had had symptoms for three months. The part removed measured twenty centimetres in length, that is to say, a total length of bowel of sixty centimetres. The intussusception was of the ileo-cæcal variety; so that the operation consisted in stitching the ileum to the cæcum.

---

## CHAPTER XLVI

### 4. VOLVULUS

Twisting of the small intestine is a comparatively rare cause of obstruction. It is found most frequently involving the lower part of the ileum, and dependent, as an indirect cause, upon some extra length of the mesentery at that particular part. The greater elongation of the mesentery may be of congenital origin, or due to prolonged stretching, the result of an old hernial loop; but from whatever cause produced, it has the effect of producing an axis around which the bowel may turn.

In most instances a complete turn is effected, usually from left to right, but any degree between a half-turn and a com-

<sup>1</sup> *Berliner klin. Wochenschrift*, 1890, No. 41, p. 914

plete one may take place. In a case reported by Dörfler,<sup>1</sup> the bowel was twisted several times upon itself. A rare form is where one coil of intestine becomes twisted round another. An illustration of such an accident is seen in the case narrated in detail below.

In many instances it is impossible to ascribe any direct cause for the bowel becoming twisted; in others, however, a definite exciting cause is found. Thus, in a case reported by Hawkins,<sup>2</sup> a woman died of acute obstruction the result of a slight blow on the abdomen. At the post mortem a figure-of-eight twist of the bowel was found. Similarly, in a case reported by Stanley,<sup>3</sup> a slight blow on the abdomen of a child aged 5 years, while at play, caused acute obstruction, from which it died in the course of forty-eight hours. At the post mortem a volvulus was found about thirty inches from the pylorus. Pennington<sup>4</sup> reports the case of a girl aged 18 years, who died of a twist of the ileum which came on after violent exercise. Briddon<sup>5</sup> records a case where the volvulus was produced by the axial rotation of a large lipoma growing from the mesentery. The tumour was removed, the bowel untwisted, and the patient made a good recovery. It is quite possible that adhesions by binding down a loop of bowel at any spot may lead to that particular portion becoming twisted. Such appears to be exemplified in a case of Callender's quoted by Hutchinson,<sup>6</sup> and in a case reported by Ashby,<sup>7</sup> where nearly the whole of the small intestine was twisted. Considerable adhesions were found to have existed previous to the acute volvulus which caused death. In some cases it would appear that the existence of a gall stone in the bowel has been the cause of rotation. Mayo Robson<sup>8</sup> reports two such cases. The twisting of a loop of bowel after slipping beneath a band is probably due to the traction of the mesentery. Pitt<sup>9</sup> has reported two cases of volvulus of the ileum

<sup>1</sup> *Brit. Med. Journ.* Epitome, 1894, vol. i. p. 18.

<sup>2</sup> *Brit. Med. Journ.* 1892, vol. ii. p. 944.

<sup>3</sup> *Ibid.*

<sup>4</sup> *Annual of the Universal Medical Sciences*, 1894, vol. iii. C—25.

<sup>5</sup> *Ibid.*

<sup>6</sup> *Archives of Surgery*, 1890, vol. i. p. 13.

<sup>7</sup> *Brit. Med. Journ.* 1891, vol. i. p. 413.

<sup>8</sup> *Trans. Royal Med.-Chir. Soc.* 1895.

<sup>9</sup> *Trans. Path. Soc. Lond.* 1891, vol. xlii. p. 123.

causing death in newly born children. Cripps<sup>1</sup> also reports a similar instance.

The effect of torsion upon the vitality of the bowel depends upon the tightness of the twist. In some instances this is so slight as to do little more than obstruct the lumen of the bowel; but on the other hand it may be so serious as to produce an effect similar to strangulation. In a case reported by McAlister,<sup>2</sup> a loop of ileum about eight inches long was twisted upon itself from left to right. The part of the gut where the twist existed was very dark in colour, and looked gangrenous. Small spots, which also looked gangrenous, were found throughout the small intestine. The bowels generally were congested and very much distended with gas.

**Symptoms.**—There are no symptoms sufficiently distinctive of volvulus to admit of it being distinguished from obstruction due to other causes. The patient may be seized suddenly with great abdominal pain, vomiting, and collapse; or the onset may be more gradual, with vague sensations of intestinal discomfort, colicky pains, constipation, and possibly some abdominal tenderness.

It is probable that the variations in the symptoms are due to the degree of rotation, or, in other words, to the completeness or otherwise of the obstruction resulting from the torsion.

**Treatment.**—Were it possible to make a correct diagnosis, probably no class of cases of intestinal obstruction would respond more favourably to treatment by abdominal taxis. The rigorous shaking it involves, together with the manipulation of the abdomen, would very likely untwist the involved loop. Where, however, this measure is either not attempted or fails, none can prove of any avail except laparotomy. The few cases tabulated below show the success which may be expected to attend such treatment.

The same rule regarding early operation applies in this class of cases equally with all others of a similar character. The untwisting of a volvulus before material change has taken place in the affected part is one of the simplest of intra-abdominal operations; but if the operation be delayed until,

<sup>1</sup> *Annual of the Universal Medical Sciences*, 1892, vol. ii. L—15.

<sup>2</sup> *Ibid.* vol. iii. C—61.

*Table of Successful Cases of Laparotomy for Volvulus of Small Intestine from 1891 to 1895 inclusive*

Operator	Nature of Volvulus	Time intervening between onset of symptoms and operation	Nature of Operation	Reference
McAlister . .	Ileum	Not given	Laparotomy and untwisting	<i>Ann. Univ. Med. Sci.</i> 1892, iii. C-61
G. R. Turner . .	Ileum	24 hours	"	<i>Brit. Med. Journ.</i> 1892, ii. 944
Dörfler . . .	Bowel twisted several times upon itself	2 days	"	<i>Ibid.</i> Epitome, 1894, i. 18
Bridgdon . . .	Due to axial rotation of large lipoma growing in mesentery	Not given	Laparotomy, untwisting; removal of tumour	<i>Ann. Univ. Med. Sci.</i> 1894, iii. C-25
Mayo Robson . .	Due to gall stone		Laparotomy and untwisting	<i>Brit. Med. Journ.</i> 1895, i. 194
" (2nd case)	Due to gall stone		"	<i>Ibid.</i>

as in McAlister's case above quoted, the part is almost gangrenous, more extensive operative interference will be necessary, and as a consequence the prognosis is less hopeful. All that has been said with reference to gangrenous gut from internal strangulation by bands or other agents applies here, either the part must be excised and an end-to-end or lateral anastomosis effected, or a fæcal fistula or an artificial anus formed.

CASE LXXXII.—*Volvulus of ileum the result of traumatism : laparotomy : untwisting. Recovery.*

A boy aged 7 years fell some twelve feet against the pole of a boat and then into the mud of the river. On admission he was much collapsed and vomited bilious matter several times. He soon became very restless, rolling himself about in bed, his legs were drawn up, and there was much abdominal pain complained of, especially in the right iliac fossa. There was considerable tenderness in this situation, but no abdominal distension, no signs of external injury. There was some tenesmus, but no flatus or fæces passed. Laparotomy was performed twenty-four hours after the accident. On examining the small intestine, an entanglement was felt just to the left of the middle line. The mass of entangled intestines was easily unravelled. The region of the gut affected was the ileum. In two separate places there were collapsed portions of bowel. The boy made an uninterrupted recovery.

The case illustrates one of the rarer forms of volvulus where one loop of intestine becomes twisted round another. (G. R. Turner, 'Trans. Med. Soc.' 1893, vol. xvi. p. 16.)

## CHAPTER XLVII

## 5. STRICTURE

IN speaking of stricture of the small intestine it must be understood that only such contractions of the calibre of the canal as result from some form of inflammation in the coats of the bowel are included under the term. Stricture from malignant disease, similar to that found in other portions of the alimentary canal, is almost unknown. Narrowing of the canal from external pressure by tumours, abscesses, &c. will be discussed later; while constrictions the result of kinking and twisting have already been dealt with.

The kind of stricture therefore embraced under the term is strictly of a cicatricial character, arising in most instances from previous ulceration, and only rarely from a chronic inflammatory infiltration of the intestinal walls, of a character similar to the gonorrhœal stricture of the urethra.

Two forms of ulcer met with in the small intestine have already been described, the typhoid and the tubercular. The former only very rarely gives rise to stenosis in the process of healing. I have not been able to find a single recorded case, and can only refer to the solitary instance quoted by Treves,<sup>1</sup> which, after a critical examination of other cases, that author believes to be the only reliable example.

Tubercular ulceration, on the other hand, affords numerous instances, and is indeed a most fruitful source of stricture. Both from the pathological course which these ulcers pursue, and the frequency with which they are met with, there is every reason to expect that they should frequently give rise to stenosis.

As already described, the tendency of a tubercular ulcer is to extend circumferentially—that is, its course round the bowel renders the subsequent process of healing most effectual in the production of stricture. The seat of the stricture, like the ulcer, is most commonly in the lower part of the ileum, although it may be found in any part of the small intestine.

<sup>1</sup> Page 255.

According to König,<sup>1</sup> who reports five cases of stricture the result of tubercular ulceration, the condition is most often met with in persons between 20 and 30 years of age, and most frequently in those who suffer from tubercular lesions in other parts.

While the cause of the symptoms may be one particular stricture, others may exist which are incapable of obstructing to any appreciable extent the normal passage. In a case reported by Voehs (see below), one stricture was situated ten inches above the ileo-cæcal valve, while a second was found about two yards higher up.

One of the most unmistakable evidences, from a pathological aspect, that a particular stricture is of tubercular origin, is the existence of miliary tubercles infiltrating the intestinal walls in the immediate neighbourhood of the lesion.

CASE LXXXIII.—*Tubercular stricture of the intestine : excision.*

*Recovery.*

A woman aged 38 years had been subject to attacks of sharp pain in the abdomen, together with vomiting. These attacks would set in suddenly and her abdomen become meteorically distended. If flatus could be passed, the pains would cease and the seizure be over. Compression of a loop of intestine was suggested. Laparotomy was performed. Two strictures were discovered, one ten inches above the ileo-cæcal valve, and the other about two yards higher up. The intestinal convolutions were found to be injected and infiltrated with miliary tubercles. The contracted portions were resected, about six or eight centimetres being extirpated. The operation lasted three hours. Forty-five hours later, flatus was passed, and the patient recovered without accident or reaction. Five months after, she was in complete health. (Chr. Voehs, 'Annals of Surgery,' 1893, vol. xviii. p. 579.)

Syphilis is another cause of stricture. According to Rieder,<sup>2</sup> who has investigated the subject, the lesions productive of obstruction are most frequently met with in the upper part of the small intestine. This lesion appears to consist in an increase of the connective tissue, at first in the submucosa, and later in the other coats.

Another comparatively infrequent source of stricture is the injury which a loop of bowel may receive when strangulated in one of the usual abdominal apertures (see Plate

<sup>1</sup> *Annual of the Universal Medical Sciences*, 1893, vol. i. D—31.

<sup>2</sup> *Ibid.*

PLATE XVIII.



Fig. 55.—STRICTURE OF SMALL INTESTINE, the result of a strangulated hernia, operated upon eight months previously. A piece of whalebone above the stricture passes through a perforation which occurred during life. (*W.I.M., Glas.*)





XVIII, fig. 55). Several cases have been recorded where, after a certain period has elapsed from the time of operation, symptoms of obstruction set in. When a loop of intestine becomes nipped at one of the rings, the part most liable to suffer is the mucous membrane. It is well known that ulceration may take place here, while very little mischief to the external serous coat is visible. The injury, however, may be of a more extensive kind, involving all the coats; so that although perforation may not take place, yet the damage to the bowel may be sufficiently great to cause some sloughing of the whole wall, which will necessarily lead to a considerable formation of cicatricial tissue in the process of repair. In two ways, therefore, stricture may result from strangulated hernia: either the mucous membrane may ulcerate and lead to the formation of circular stricture, or a portion of the wall die and be repaired by cicatricial tissue.

The cases recorded are too few to admit of any statement regarding the relative frequency of stenosis after either inguinal or femoral hernia. In the case recorded by Pitt (see below), the hernia was a femoral one; while in one reported by Garré<sup>1</sup> it was an inguinal. The period at which symptoms of stricture appear after the accident of strangulation apparently vary considerably. In Pitt's case they commenced five days after the hernia was reduced; while in Garré's it was nine weeks.

CASE LXXXIV.—*Stricture of ileum, secondary to ulceration produced by strangulation of the bowel in a femoral hernia: perforation. Death.*

Sarah D., aged 43 years, had suffered from reducible femoral hernia. Eleven weeks prior to admission into hospital she was standing on a chair hanging some clothes. In so doing she strained herself, and both herniæ came down. She was in intense pain and had to be carried to her bed. The herniæ remained down for a week, when they were reduced and the bowels opened with an enema.

Vomiting commenced five days after the accident, and from that time on, it continued with variable intermittence. Her bowels became very irregular. She always felt pains in the back when they moved. Abdominal pain came on in paroxysms lasting a quarter to half an hour.

When admitted she was seen to be greatly emaciated, and in appearance almost moribund. The abdomen was distended and tympanitic, with

---

<sup>1</sup> *Centralblatt für Chirurgie*, 1892, p. 663.

no evidence of tumour. There was tenderness and pain in the epigastric and right hypochondriac regions. When paroxysms of pain came on, the abdominal walls became rigid, and most marked tenderness was always felt to the right of the umbilicus. Considerable improvement took place under careful feeding, but any excess in the diet increased the sickness. The bowels opened only every second or third day. Death resulted from perforation, four and a half months after the bowel was incarcerated. At the post mortem a marked contraction of the ileum was found about four feet from the cæcum; the distended bowel above measured four and a quarter inches in circumference, but at this point it was suddenly reduced to an inch and a half. At the seat of contraction the calibre of the bowel was seven-eighths of an inch, and the part showed extensive ulceration, with thickening and cicatrisation of the mucous membrane involving the whole circumference. (G. N. Pitt, 'Trans. Path. Soc. Lond.' 1891, vol. xlii. p. 119.)

Still rarer causes of stricture are such as arise from some form of traumatism. Thus a foreign body becoming impacted gives rise to ulceration, and this, if repair subsequently takes place, may lead to stricture. A blow on the abdomen, causing contusion of the intestine, may give rise to some chronic inflammatory mischief which ends in a narrowing of the canal. Treves<sup>1</sup> quotes two instances—one where the patient was ridden over, and one where a blow was received upon the abdomen. In the former case symptoms of obstruction came on three months after the accident, and in the latter, four months. Mygind<sup>2</sup> reports a case of stricture the result of a blow upon the abdomen. Successful excision was performed six months after the receipt of the original injury.

Frequently in cases of so-called simple stricture it is not possible to ascribe any definite cause. It is more than likely, however, that some ulceration insufficient to cause symptoms has preceded the formation of cicatricial tissue. Whether chronic enteritis, like chronic urethritis, can cause stricture is unknown.

CASE LXXXV.—*Simple stricture of the small intestine at junction of jejunum and ileum: enteroplasty. Recovery.*

A woman aged 48 years was admitted into the Great Northern Hospital. She stated she had never had typhoid fever or dysentery. About three months ago, she was suddenly seized with pain in the abdomen after a cup of tea, and was treated for dyspepsia. Ever since that attack she

<sup>1</sup> Page 265.

<sup>2</sup> *Annual of the Universal Medical Sciences*, 1892, vol. iii. C—66.

had had violent griping pains from time to time. A fortnight before admission she noticed her abdomen swollen. She had been sick several times. The bowels had acted badly, the motions being loose and scanty. For some time she had been losing flesh. On admission to hospital the abdomen was found to be considerably distended, principally over the lower part. It was resonant all over; there was no fluid in the flanks; deep palpation excited peristaltic action, and the distended coils of intestine stood out very distinctly through the abdominal walls. A good deal of gurgling could be heard and felt. The temperature was normal, and the pulse was rather rapid and feeble; the urine was scanty, loaded with urates, high coloured; no albumen. The face was pinched. She was greatly emaciated; complained of a good deal of griping pain during the night. The bowels were open, the motions being loose, but containing neither blood nor slime. Laparotomy was performed. A stricture was found at the junction of the jejunum and ileum, and treated successfully by enteroplasty, an operation similar in its performance to that of pyloroplasty. (Allingham, 'Lancet,' 1891, vol. i. p. 1551.)

As a last cause of stricture, brief reference may be made to that which apparently owes its origin to some congenital defect, either the result of disease during foetal life or of some malformation. A congenital origin of a stricture is probable in cases where the symptoms develop early. Rolleston showed a specimen at the Pathological Society of London,<sup>1</sup> which he believed to be the result of maldevelopment. Stenosis of the jejunum was found about two feet from the duodenum; two other strictures also existed. From the strictures appearing like membranous diaphragms, and there being no evidence of disease, it was thought they might possibly be due to some maldevelopment of the valvulae conniventes.

*The nature of the stricture and its pathological sequels.*—The kind of stricture is mostly determined by the character of the ulcer which preceded it. The deeper and wider the process of ulceration, and the more completely circumferential its extent, the more seriously obstructive becomes the subsequent cicatrix. In some instances the stricture is so narrow in its longitudinal involvement of the bowel, that externally it has the appearance as if constricted by a string tied tightly around it. In other cases an inch or more of the calibre of the canal is narrowed. In a case of Fagge's, quoted by Pitt, where stricture followed upon a strangulated hernia, an inch and a

<sup>1</sup> *Trans.* 1891, vol. xlii. p. 122.

half of the gut was narrowed. Its coats were thickened by hard white cicatricial tissue. The mucous membrane was almost devoid of villi.

The effect of obstruction at any point is to cause dilatation of the canal above, and hypertrophy of its muscular walls. These changes are most marked in the immediate neighbourhood of the contraction, becoming less so as the more distant parts are reached. In most cases the dilatation is uniform; in others, however, a pouch or saccule is formed in which, either as a cause or as a consequence, a foreign body such as a fruit stone is frequently found. The mucous membrane above the stricture is often found ulcerated, and should the patient live long enough and the process of ulceration continue, there is the possibility of perforation, with its various complications of adhesions, abscesses, fistulæ, or more extensive inflammation.

**Symptoms.**—From whatever cause produced, the symptoms connected with stricture of the bowel are much the same. Differences will naturally exist in the early history of the case, as for instance where tubercular ulceration has been the cause of antecedent diarrhœa; or strangulated hernia existed; or some injury has been received; but when once cicatricial contraction has definitely set in, the symptoms in every case become practically indistinguishable.

The onset of the symptoms varies. In some cases the progress of the disease is marked simply by a vague sense of intestinal discomfort with slight pains which come and go; with loss of flesh, and increasing weakness. In other cases the earliest symptoms of intestinal trouble are those indicative of acute obstruction. There is persistent vomiting, obstipation, with increasing distension of the abdomen, all of which indicate a complete blockage of the bowel.

The symptoms therefore are largely dependent upon the amount of obstruction to which the stricture gives rise. When symptoms manifest themselves at a period prior to any marked contraction of the calibre of the canal, they usually arise from some temporary blockage of the passage. In such cases the patient is seized with vomiting and griping pain, which soon disappear as the temporary obstacle is passed on. These attacks, however, reappear, and that with increasing

frequency as the stricture contracts and the canal becomes narrower in calibre.

This temporary blocking of the canal at an early stage of the disease usually owes its origin to the existence of some indigestible material in the bowel—such for instance as fruit stones, fruit skins, &c.—or to a too solid condition of the *faeces*. It not infrequently happens that the patient becomes conscious of the fact that any indiscretion in diet, or the consumption of certain indigestible substances, is certain to be followed in the course of a few days by the onset of an attack; and, on the other hand, a careful selection of foods retards the frequency with which these attacks of griping pains recur.

The early attacks may be short, but as the tightness of the stricture increases they become prolonged. The pains become more acute in character, and resemble severe attacks of colic. Unless relief soon follows, the abdomen begins to distend, and the peristaltic movements of the bowel may become visible through the parietes, especially during the paroxysms of pain. Persistence of the obstruction leads to all the symptoms which usually follow upon complete obstruction arising from other causes.

The condition of the bowels varies; in many instances there is constipation, in others the motions are loose. The abdomen is not usually painful on palpation, but a sense of gurgling is often detected both by the ear and the hand.

If death is not brought about by an acute attack of obstruction which remains unrelieved, it usually results sooner or later from emaciation and exhaustion. Such possible complications as perforation above the seat of stricture may cause death at any period of the disease from acute peritonitis.

There are cases where no symptoms have existed prior to those associated with a sudden and complete blockage of the strictured part. In these cases the symptoms are similar to those met with in other cases of acute obstruction, and become therefore indistinguishable from those the result of internal strangulation, volvulus, and other such like causes. Sudden pain sets in, which, while more or less continuous, is frequently increased by paroxysmal attacks: vomiting proves incessant, becoming feculent in the course of a few days: neither *faeces*

nor flatus is passed : meteorism soon makes its appearance ; and death ensues usually within a week.

These acute cases owe their origin to the same cause which gives rise to slight and temporary attacks in cases where the stricture has not become specially tight. Instead of the foreign body or the mass of fæces becoming loosened, dislodged, and passed, it remains impacted and permanently blocks the narrowed passage.

It occasionally happens that the patient is suddenly relieved by the passage of a copious motion. If after such relief acute symptoms immediately set in, the probability is that perforation of the bowel above the seat of stricture has taken place. Without, however, the sudden onset of such grave symptoms, it may be assumed that some portion of the obstruction has given way and allowed the block to be dislodged and passed on.

**Treatment.**—The organic nature of the obstruction renders any conservative measures useless, when treatment is considered from a curative point of view. It is possible, however, to give considerable relief in many cases by a careful regulation of the diet. It has already been stated that patients themselves frequently find that certain foods, especially those of an indigestible nature, are liable in the course of a few hours after ingestion to provoke an attack of pain and vomiting. Hence such indications should be taken as a good guide regarding the conservative treatment to be followed out.

When, however, symptoms of complete and permanent obstruction manifest themselves, little or no hope can be looked for by delay.

The simplest and in one sense the safest operative measure the surgeon can adopt is merely to relieve the distended bowel by making an abdominal incision and opening the first distended loop which presents. The establishment of an artificial anus will, if the bowel has not lost its contractile power through prolonged over-distension, end in the copious ejection of its contents, with immediate relief to the patient's sufferings. This measure, however, can only be considered temporary, and a subsequent operation will be necessary to deal with the stricture.

Two ways of dealing with the stricture have been successfully carried out. The most radical, as illustrated by Garré's

and Mygind's cases, is to excise it and unite the ends. This, when effected by Murphy's button, can be very rapidly executed. The second method is to adopt the plan successfully followed by Péan<sup>1</sup> and by Allingham,<sup>2</sup> of performing what is correctly termed 'enteroplasty,' from its resemblance to the Heineke-Mikulicz operation of pyloroplasty. The stricture is divided longitudinally and the edges of the incision united transversely.

The rapidity with which either of these methods can be carried out renders them possible as primary measures after opening the abdomen in the middle line, below the umbilicus. If for any reason the means are not at the surgeon's disposal to render the operation a rapid and safe one, he will be wiser to defer the radical treatment of the stricture for a secondary operation, and be satisfied with a fæcal fistula for the time being.

The usual after treatment should be adopted, nutrient enemata taking the place of nourishment by the mouth for the first few days.

---

## CHAPTER XLVIII

### 6. GALL-STONES. INTESTINAL CONCRETIONS

THESE occasional contents of the bowel have already been briefly alluded to under the heading of 'Foreign bodies,' which in a sense they practically are. But there are many points about them sufficiently distinctive to render a separate consideration necessary.

**Gall-stones.**—Disease the result of gall-stones in the intestine more frequently occurs in females than in males, in the proportion of four to one, and rarely manifests itself before middle age. In sixteen cases collected by Treves,<sup>3</sup> the average age was 57 years. In only one instance was the patient under 40 years, and in that the woman's age was 27 years. The oldest woman was 78 years.

The stone finds its way into the bowel either by the common bile duct or by ulceration into the third part of the duodenum, usually direct from the fundus of the gall bladder.

<sup>1</sup> *Annual of the Universal Medical Sciences*, 1892, vol. iii. C—69.

<sup>2</sup> See Case LXXXV. p. 396.

<sup>3</sup> Page 326.

Probably in the majority of instances where intestinal mischief is subsequently set up, the stone has been too large to pass by the duct, and has found its way into the bowel direct by ulceration.

Mayo Robson<sup>1</sup> has classed under four heads the ways in which gall-stones may give rise to obstruction.

(1) The paralytic form, dependent on local peritonitis in the region of the gall bladder.

(2) Volvulus of the small intestine dependent either on the violence of the colic caused by an attack of cholelithiasis, or on the contortions induced by the passage of a large concretion through the small intestine.

(3) Mechanical obstruction due to the passage of a large concretion through the small intestine.

(4) Obstruction depending on adhesions or on stricture the result of past gall-stone attacks, or of healing fistulæ.

The form of obstruction most frequently met with is that classed as (3). The obstruction is mechanical, and due to the blocking of the bowel at some point by the gall-stone becoming impacted. The neighbourhood of the ileo-cæcal valve in the ileum is the most common seat of obstruction.

The stone which becomes impacted is usually a large one but size does not appear to be the sole determining factor, for stones quite as large as any which have caused serious symptoms have been passed without material trouble. It is possible that in not a few instances either the state of the contents of the bowel or sluggishness in its peristaltic action causes the calculus to become coated with fæcal concretion, and hence its size so augmented that obstruction ensues. It is often found that the stone, when passed or removed by operation, is surrounded with a considerable quantity of fæcal material.

As illustrating some of the sizes of stones met with, one shown by Marshall<sup>2</sup> at the Glasgow Pathological and Clinical Society may be instanced. It weighed 4 drachms 3 grains, and measured  $1\frac{3}{4}$  inch in length, and  $3\frac{1}{4}$  inches in circumference at its thickest part. The stone was passed *per rectum*. H. E. Clark,<sup>3</sup> before the same Society, showed one which weighed

<sup>1</sup> *Brit. Med. Journ.* 1895, vol. i. p. 194.

<sup>2</sup> *Trans.* 1893, vol. iv. p. 227.

<sup>3</sup> *Ibid.* 1891, vol. iii. p. 65.



$3\frac{1}{2}$  drachms and measured  $1\frac{1}{2}$  inch in length, 1 inch in breadth, and  $3\frac{3}{4}$  inches in circumference. It had caused intestinal obstruction, and was removed by enterotomy. Taylor<sup>1</sup> figures in the 'Lancet' a stone which weighed  $1\frac{1}{4}$  oz., was  $4\frac{1}{2}$  inches in circumference and 2 inches in length. It was successfully removed by enterotomy. For exceptional examples of much larger stones, Murchison's well-known work on Diseases of the Liver should be consulted.

**Symptoms.**—Obstruction from gall-stones adds still another cause to the many which give rise to acute symptoms without often indicating the true nature of the cause.

In the cases which fall under the first heading of Mayo Robson's classification there will be, in addition to the symptoms of acute obstruction, pain and tenderness about the region of the gall bladder, due to the local peritonitis set up in that part.

In the more frequently met with class of cases of mechanical obstruction, the symptoms may commence suddenly and in a way quite similar to acute obstruction from other causes. The patient while in perfect health is suddenly seized with violent abdominal pain, vomits incessantly, and passes neither flatus nor fæces. The vomit, at first bilious, becomes in the course of a few days fæcal. The patient soon shows the characteristic, drawn, sunken, anxious face. The abdomen, not tender or distended at first, may become so. A dry tongue with parched mouth, and thirst causes much distress; and if the obstruction is to prove fatal, peritonitis may supervene and the patient die of exhaustion.

The early history of the case sometimes affords a clue in these cases of mechanical obstruction. Thus the patient may have had previous attacks of biliary colic accompanied with jaundice and the passage of gall-stones; or there may have been some tenderness and pain in the region of the gall bladder, due to the process of ulceration taking place there while the stone found its way into the duodenum. In very many cases, however, no such history will be forthcoming, for large stones will sometimes pass directly from the gall bladder into the duodenum without causing any manifest disturbance.

In some cases gall-stones remain for a considerable time

<sup>1</sup> *Lancet*, 1895, vol. i. p. 867.

in the bowel, giving rise to intermittent attacks of obstruction, and producing symptoms suggestive of stricture. In Taylor's case, above quoted, the patient suffered for twenty-six days from symptoms of variable acuteness. On the twenty-seventh day obstruction was complete and fæcal vomiting appeared.

Physical examination of the abdomen does not usually afford much information. It is possible sometimes, however, with the patient under an anæsthetic, to feel the stone. Such was the case in a patient of Eve's,<sup>1</sup> in whom he was able to detect the calculus in the left iliac fossa.

**Prognosis.**—Possibly there is no cause which gives rise to typical symptoms of acute obstruction that can be considered so hopeful in its ultimate issue as that of an impacted gall-stone. The most severe symptoms may manifest themselves, but these may completely subside, the patient pass the gall-stone *per anum*, and perfect recovery ensue. Numerous cases are reported in proof of this. To instance only two. T. K. Monro<sup>2</sup> showed a specimen at the Glasgow Medico-Chirurgical Society of a stone which had been passed *per rectum*. The patient was taken suddenly ill after eating a hearty supper. When seen the following day, she was found to be suffering from severe sickness and vomiting with great abdominal pain, the symptoms suggesting acute obstruction. They all, however, gradually disappeared and the patient passed the calculus; no further trouble followed. In the other instance, a case quoted by Hutchinson,<sup>3</sup> the symptoms were of such extreme severity that on the sixth day all hope was abandoned and it was expected the woman would die that night. The following morning, however, improvement set in, and on the next day she voided a gall-stone which measured an inch in diameter. Complete recovery followed. Recovery may even take place after the appearance of fæcal vomiting. Murchison<sup>4</sup> instances a case where this symptom had lasted for upwards of three weeks.

While, however, there is the possibility of recovery, there appears, judging by Treves's statistics,<sup>5</sup> the greater probability

<sup>1</sup> *Brit. Med. Journ.* 1895, vol. i. p. 195.

<sup>2</sup> *Glasgow Medical Journal*, 1895, vol. xliii. p. 447.

<sup>3</sup> *Archives of Surgery*, 1892, vol. iii. p. 9.

<sup>4</sup> *Lectures on Diseases of the Liver*, 2nd edit. p. 494.

<sup>5</sup> Page 335.

of death. Thus out of twenty cases where definite and severe symptoms of obstruction existed, six recovered and fourteen died.

Unfortunately there are no symptoms which enable one to state in any case whether or not the stone will move on. It is always reasonable to entertain the hope of nature effecting a cure unaided; but the great difficulty is to say how long such a hope is to be entertained; how long, in short, should the symptoms be allowed to continue before operative intervention is permitted.

**Treatment.**—It has already been pointed out that in very many instances obstruction from gall-stone will not be diagnosed until laparotomy is performed. It must be assumed here, however, that for the sake of discussion we are dealing with cases where gall-stones are known to be the cause of the symptoms.

Treatment should in the first place consist of purely conservative measures. An anæsthetic should be given, large quantities of fluid injected into the rectum and colon, and abdominal taxis practised.

Following upon this some belladonna and opium should be administered, all nourishment withheld from the stomach, and the patient kept at rest.

In almost every instance the stone at an early stage of the attack is capable of being dislodged from its seat. It is always possible therefore that these energetic measures may prove sufficient, and within a short time of their performance the patient may pass flatus and later a copious stool. The stone occasionally gets stopped just above the sphincter, and gives rise to considerable inconvenience and pain in its final ejection through the anus.

Should these measures fail to give relief, the question of delay or the immediate performance of enterotomy has to be considered.

If the results of operations were more successful than they at present seem to be, not much difficulty would exist in deciding the proper course to pursue. The fact, however, that statistics show but little preference for interference over non-interference renders the matter far from being an easy one to settle. Treves gives six recoveries out of twenty where *no*

operation was performed, and Eve,<sup>1</sup> in January 1895, stated that since 1889 eighteen cases had been recorded which had been operated upon, and nine had recovered. Terrillon<sup>2</sup> has collected twenty-three similar cases, seven of which were successful after operation.

By contrasting the percentage recoveries it is seen that where no operation was performed there were 30 per cent., and where operated upon, 50 per cent. in one list and 30·4 per cent. in the other. It is quite possible that these statistics are very fairly comparable, because in both instances of operation and non-operation it is much more likely that natural recoveries and recoveries after operation would be published than the deaths attributable either to the one or to the other. The difference, however, cannot be considered sufficiently great to settle the question in favour either of delay or operation.

Irrespective of statistics, cogent factors which need to be taken into account in any endeavour to decide upon the proper course to pursue are the circumstances attending the immediate surroundings of the patient. In the case of hospital patients the conditions would be practically the same as in the case of patients in their own private homes, where nature is left to her own unaided efforts. They would, however, be markedly different in the case of operations performed in these respective places. Herein therefore probably exists the solution of the difficulty. If the conditions are such as will permit of the operation being performed with all the most approved requisites, and by one sufficiently experienced, then there can be but little doubt that the best results will, on the whole, be attained by the performance of enterotomy. Failing, however, both these essentials, the practitioner will act more wisely in refraining from operation.

**Operation.**—In performing entero-lithotomy, the usual precautions must be taken in the preliminary process of opening the abdomen. The parietal incision should be in the middle line, below the umbilicus.

The lower part of the ileum should first be sought for as being the probable seat of the calculus. When found, an

<sup>1</sup> *Brit. Med. Journ.* 1895, vol. i. p. 195.

<sup>2</sup> *Annual of the Universal Medical Sciences*, 1894, vol. iii. C—27.

endeavour should be made by gentle external manipulation to squeeze the stone on, and if possible get it through the ileo-cæcal valve into the cæcum. Clutton<sup>1</sup> reports a case in which he successfully managed to do this. The stone was situated about eight inches from the valve. Five days after the operation the stone was passed, when it was found to measure  $1\frac{1}{4}$  inch in length, 1 inch in its largest diameter, and  $3\frac{3}{10}$  inches in its largest circumference. If it proves possible to thus effect dislodgment, nothing further remains to be done except to close the abdomen.

If the stone cannot be displaced, the bowel should, if possible, be drawn out of the abdomen and incised in a longitudinal direction over the stone, and the latter extracted. Prior to opening the bowel every possible precaution must be taken, by the proper application around of sponge cloths, &c., to prevent any contamination of the peritoneum by the contents of the intestine. In many instances death has resulted from septic peritonitis.

After the stone is withdrawn, the opportunity should be taken, which the opening in the gut affords, of allowing the escape of any fæces or flatus which may be overdistinging the bowel above. The edges of the mucous membrane should then be stitched together by a continuous suture, and the external coats united by a series of Lembert stitches. Should there be any suspicion of escape of fæcal material into the peritoneal cavity, it should be freely flushed and sponged dry before closing the parietal wound.

As possible contingencies to be encountered and dealt with, the surgeon may have to consider the propriety of excising the area of impaction or stitching the bowel orifice to the abdominal wound and so forming a temporary fæcal fistula. One of these courses must be pursued when, from ulceration or other damage to the bowel wall at the seat of impaction, the parts are not in a condition to be safely stitched up and returned. Adhesions may have to be separated; and the twisting of a coil undone which, as already pointed out, is sometimes associated with a gall-stone.

<sup>1</sup> *Trans. Clin. Soc. Lond.* 1888, vol. xxi. p. 99.

*Table of Successful Cases of Entero-lithotomy for impacted Gall-stones causing Intestinal Obstruction, from 1891 to 1895 inclusive*

Operator	Nature of Obstruction	Time intervening between onset of symptoms and operation	Nature of Operation	Reference
Thiariar . . .		11 days	Entero-lithotomy	<i>Revue de Chirurg.</i> 1891, p. 403
Bruce Clarke . . .				<i>Lancet</i> , 1893, i. 1196
Körte . . . . .		7 days	Entero-lithotomy	<i>Brit. Med. Journ.</i> Epitome, 1894, i. 50. See also <i>Berl. klin. Wochen.</i> 1893, p. 690
(This author refers to 3 other cases, in 2 of which he operated successfully)				
W. A. Lane . . .	Impacted in jejunum	5 days	Entero-lithotomy	<i>Lancet</i> , 1894, ii. 382
Terrillon . . . . .		Not stated	of which " 7 were	<i>Ann. Univ. Med. Sci.</i> 1894, iii. C-27
(This author has collected 23 similar cases, successful)				
H. Vernon . . . . .	Impacted in ileum	Not given	Entero-lithotomy	<i>Brit. Med. Journ.</i> 1894, ii. 1179
Mayo Robson . . . . .			"	<i>Trans. Royal Med. Chir. Soc. Lond.</i> 1895, lxxviii. 117
" (2nd case)			"	<i>Ibid.</i>
W. C. E. Taylor . . . . .	Lower part of ileum	26 days subacute symptoms, 27th day acute with faecal vomiting	"	<i>Lancet</i> , 1895, i. 867
F. Eve . . . . .	Lower end of ileum, 2 or 3 inches from ileo-caecal valve	5 days	"	<i>Trans. Clin. Soc. Lond.</i> 1895, xxviii. 97

CASE LXXXVI.—*Gall-stone causing acute intestinal obstruction : entero-lithotomy. Recovery.*

A woman aged 54 years was admitted into Guy's Hospital on Tuesday night, April 24, suffering from symptoms of acute intestinal obstruction, which had commenced at 8 A.M. on Friday, the 20th, more than four and a half days previously. From the commencement of the attack she had suffered from very severe griping pains at frequent intervals, from vomiting, and from obstipation. When admitted into hospital, the abdomen was distended, very tender on pressure, and a distinct thrill could be felt on percussion. Vomit not faecal. Her past history was that for the last three years she had suffered off and on from attacks of indigestion, during which she experienced much distension of the abdomen, with some tenderness on pressure. Two or three months after the appearance of the indigestion she was jaundiced for several days. There had never been any particular pain or tenderness in the region of the gall bladder. Laparotomy was performed four and a half days after the onset of the symptoms. A gall-stone was found impacted in the bowel, about eight feet from the duodenum. The peritoneal cavity contained a quantity of turbid fluid tinged with

blood. The upper part of the jejunum was very much distended; the walls of the bowel were deeply injected and covered with lymph where the coils approximated each other. The bowel below the obstruction was quite empty. The stone was removed through an incision which was afterwards closed with horsehair. Great difficulty was experienced in getting the distended bowel back into the abdominal cavity. The patient made an uninterrupted recovery. (W. A. Lane, 'Lancet,' 1894, vol. ii. p. 382.)

**Intestinal concretions or enteroliths.**—It is rarely that these form or collect in the small intestine sufficiently to give rise to obstruction. They are much more frequently met with in the large bowel. When present in the former, they are usually found about the lower end of the ileum. Treves<sup>1</sup> figures a specimen which exists in St. Thomas's Hospital Museum. The small intestine is almost entirely blocked at one point by a dense mass of magnesia which fills the gut for several inches. Myles<sup>2</sup> gives the details of a case in which symptoms of complete intestinal obstruction were produced by an enterolith impacted in the ileum. The patient had suffered fifteen years before from hepatic colic, and since then from chronic constipation. The history of the case would thus seem to point to the calculus being possibly biliary in its origin; and as no section of it was made, the question of its being, as described, an intestinal concretion, must remain somewhat doubtful. Schroeder's case, given in detail below, is an interesting example of a case where the symptoms which followed were never sufficiently acute to prove fatal. It further illustrates the probable way in which many of these calculi are formed—that is, by the free and prolonged use of some salt or mineral substance.

**CASE LXXXVII.**—*Intestinal concretion causing prolonged symptoms of obstinate constipation.*

A man aged 53 years had suffered for twenty-three years from agonising attacks of abdominal colic, obstinate habitual constipation, hæmorrhoidal bleedings, meteorism, cardiac palpitation, and headache. During the last five years or so his stools had been occasionally followed by spells of spasmodic abdominal pain, with discharge of thready or flaky mucus. In the course of such an attack a hard foreign body was discharged, after which the patient gradually lost all his symptoms. The foreign body proved to be a friable, bean-shaped, pale brown calculus measuring three and a half by

<sup>1</sup> Page 339.

<sup>2</sup> *Brit. Med. Journ.* 1891, vol. i. p. 288.

one and a half centimetres, and weighing 62 grains. It was composed of a thin superficial stratum of a pale brown colour and a thicker greyish inner layer, with a small, white, central nucleus. The concretion consisted of carbonate and phosphate of lime, its external layer containing a large proportion of red oxide of iron. The presence of the latter constituent may be easily explained by the fact that five years previously the man had been treated by the Marienbad-Kreuzbrunnen mineral water, containing chalybeates in the form of carbonate of iron. (Von Schroeder, 'Annual of the Universal Medical Sciences,' 1892, vol. i. D—21.)

---

## CHAPTER XLIX

### 7. TUMOURS OF THE BOWEL WALL. INNOCENT AND MALIGNANT

NEITHER the jejunum nor the ileum is a frequent seat for the development of new growths. Such as do arise affect mostly the internal coats, and by their increase in size tend to obstruct the canal. It is usual to consider these neoplasms under the common classification of innocent and malignant.

**Innocent.**—*Fibromata.*—Tumours composed chiefly of fibrous tissue develop in the submucous coat and then project into the canal, forming one of the kinds of polypus which are occasionally met with in the small intestine. According to Leichtenstern,<sup>1</sup> intestinal polypi are most frequently met with in the lowest part of the ileum, hardly ever in the upper part, and only occasionally in the jejunum. Taking the intestine as a whole, their commonest seat is in the rectum, where they will be again referred to. Hale White<sup>2</sup> records the case of a polypus in the upper part of the jejunum. It gave rise to intussusception and death.

*Myomata.*—These tumours, composed partly of unstriped muscle tissue, arise from the muscular coat of the bowel, and usually take the form of polypus. A somewhat unusual illustration of a vascular myoma is recorded by Mercer.<sup>3</sup> A patient died suddenly in twenty-four hours from intestinal hæmorrhage, with no previous symptoms. At the post

<sup>1</sup> Ziemssen's *Cyclopædia*, vol. vii. p. 634.

<sup>2</sup> *Trans. Path. Soc. Lond.* 1890, vol. xli. p. 121.

<sup>3</sup> *Annual of the Universal Medical Sciences*, 1889, vol. i. D—15.



mortem a vascular myoma ten centimetres in diameter was found attached by a pedicle to the ileum; a small oval opening in the mucous lining of the ileum corresponded to the attachment of the pedicle, and from this it is supposed the fatal hæmorrhage occurred.

*Adenomata*.—These tumours, glandular in structure, arise from Lieberkühn's follicles. Like the two preceding, they form polypi which project into the bowel. Tito-Carbone<sup>1</sup> found an adenoma in the lower part of the jejunum, between the muscular and mucous coats. It was irregular in shape, and measured five millimetres in diameter.

*Lipomata*.—Fatty tumours are sometimes found. They develop in the submucous tissue, and are frequently multiple. They rarely cause obstruction.

*Cysts*.—These probably constitute the rarest kind of tumour met with in the small intestine. Buchwald<sup>2</sup> reports the case of a boy who died of obstruction. At the post mortem two cysts were found connected with the walls of the jejunum. Their weight had caused them to so drag upon the gut wall that the canal became almost occluded.

The various kinds of innocent tumours do not give rise to any symptoms whereby they may be diagnosed. If they cause obstruction it may either be of an acute or a chronic character. Those which form polypi not infrequently induce intussusception. In such cases it is usual to find the polypus at the apex of the intussusceptum.

A class of innocent tumours has already been referred to (see page 202) which, solid in their structure and often malignant in their clinical features, possess the peculiar faculty of disappearance. They are spoken of more generally as solid tumours of the abdomen which spontaneously disappear. Their actual connections are unknown, but they appear in some cases to be intimately connected with the intestines. They are usually ascribed to inflammation, although the evidences are not always in support of such an explanation. Greig Smith,<sup>3</sup> who has carefully considered the possible origin of these tumours, arrives at the follow-

<sup>1</sup> *Annual of the Universal Medical Sciences*, 1891, vol. i. D—20.

<sup>2</sup> *Ibid.* 1888, vol. i. p. 357.

<sup>3</sup> *Trans. Royal Med.-Chir. Soc. Lond.* 1894, vol. lxxvii. p. 139.

ing conclusion: 'They are simply aggregations of embryonic cells and tissues, heaped up around an intestinal perforation. The perforation is minute and the amount of escaping fluid is small, so that the cells can effectively deal with it. The perforation remains open for a long period of time, and the continued demand for new cells results in an aggregation which is practically a tumour.'

The symptoms to which these tumours give rise are often of an obstructive character; and the sensation which they convey to the touch usually suggests sarcoma.

CASE LXXXVIII.—*Spontaneous disappearance of a solid tumour of the intestines causing obstruction. Enterostomy.*

A young man, aged 25, was sent to the Bristol Infirmary on June 1, 1889. He was then suffering from intestinal obstruction. The cause of the obstruction was found on operation to be a solid tumour as large as a cocoon, occupying the left iliac region. An aspirator needle introduced into the growth proved it to be solid. Intestines were in several places adherent to it. It might have been removed, but as the patient was ill from the obstruction, and sarcoma was diagnosed, it was considered advisable to be content with intestinal evacuation and drainage. Enterostomy was performed in the lower ileum, the gut being fixed in the median parietal incision. For about a fortnight all the fæces passed through the artificial opening; but gradually fæces, increasing in amount, appeared by the rectum. When the abdomen was flat the tumour caused quite a marked and localised bulging in the left lower abdomen, and was easily palpable. At the end of six months it was evident that the intestinal passage had been restored, so the artificial opening was closed by operation. At this time no tumour could be felt through the parietes; and at the time of operation the finger inserted into the abdomen felt only adhesions, but no trace of tumour. The patient rapidly regained strength and put on flesh; and now, after four and a half years, remains quite well. (J. Greig Smith, 'Trans. Royal Med.-Chir. Soc. Lond.' 1894, vol. lxxvii. p. 140.)

**Malignant tumours.**—Cancer, whether in the form of carcinoma or sarcoma, is a comparatively rare disease of the small intestine. Nevertheless unmistakable cases occur, which prove that the bowel may be affected both primarily and secondarily.

*Carcinoma.*—The lining cells of the mucous membrane are of the columnar type of epithelium. Hence, as would naturally be expected, columnar-celled carcinoma or epithelioma is the form most frequently met with. It is unfortunate that there

is some lack of uniformity in the terms applied. Ransom<sup>1</sup> speaks of having met with a case of glandular carcinoma, but the drawings which are given do not show that the growth was formed of columnar cells. The extreme care with which the author investigated the case appears to imply that it was considered one of exceptional rarity, and not following the usual type. Three other cases are referred to as resembling this one, two reported by Lubarsch and one by Langhaus.

The cases are too few to admit of any specialisation as regards relative frequency in one portion of the canal or in another. Such cases as I have been able to find reported show that carcinoma may occur at any part. Thus in one case, reported by Riegel,<sup>2</sup> the disease was situated in the upper part of the jejunum; in another, by Morton,<sup>3</sup> it was at the lower end of the ileum.

Whether the disease commence as a nodule beneath the mucous membrane, or as a plaque on the surface, its progress is usually round the bowel, so that sooner or later a circular constriction results, with all the attendant ills of gradual obstruction to the onward passage of fæces. The constriction may be so tight that the affected portion appears as if encircled by a piece of string. In addition to the growth inwards which narrows the canal, the intestinal coats are sometimes greatly thickened by the infiltrating growth of the tumour. A certain amount of ulceration takes place on the surface of the growth internally.

When once constriction has become a marked feature in the case, other changes ensue in the part of the bowel above. These have already been fully referred to in discussing cicatricial stricture, and being quite similar need not be repeated here.

Secondary deposits are occasionally found infiltrating the intestinal wall. Ransom<sup>4</sup> refers to a case recorded by Chiari, where the ileum was infected with a secondary growth, the primary disease being in the gall bladder. These secondary

<sup>1</sup> *Lancet*, 1890, vol. ii. p. 1020.

<sup>2</sup> *Medical Chronicle*, 1891, vol. xiii. p. 127.

<sup>3</sup> *Trans. Path. Soc. Lond.* 1893, vol. xlv. p. 89.

<sup>4</sup> *Lancet*, 1890, vol. ii. p. 1020.

tumours, however, are not prone to produce any obstructive symptoms.

**Symptoms.**—There is little, if anything, which can be said to distinguish the symptoms of carcinomatous stricture from those which follow upon stricture from any other cause, with the one possible exception that in some instances a tumour may be felt through the abdominal parietes. In the case reported by Morton, where, as already stated, the tumour existed at the lower end of the ileum, a well-defined lump about the size of a walnut could at times be felt in the left iliac fossa. In Riegel's case, quoted above, the situation of the stricture high up in the jejunum led to the case being taken for one of disease at the pylorus. The stomach became dilated, and there was constant vomiting. The one distinguishing feature, however, was the frequent presence of bile in the vomit, which showed that the obstruction was below the duodenal orifice of the common bile duct.

A case is reported by Voelcker<sup>1</sup> which is called malignant disease, but is not classed as either carcinoma or sarcoma. The upper part of the jejunum was the seat of a soft ulcerating new growth. The gut at the seat of the disease was much dilated. It ulcerated into the ascending colon. The patient, a man, seemed quite well up to within three weeks of his death, when he was seized with diarrhoea, which continued till the end.

**Treatment.**—The treatment of stricture from carcinoma resembles in all respects stricture due to other causes; either the distended bowel above should be opened and a fæcal fistula formed to afford temporary relief, as in Morton's case, or the more radical measure of enterectomy should be performed.

**Sarcoma.**—Sarcoma, like carcinoma of the small intestine, is a comparatively rare disease. It is equally fatal in character, but possesses differences in its mode of involvement of the bowel, and in the symptoms to which it gives rise.

Sarcoma affects the bowel in two forms. In the first it resembles the fibromata, adenomata, and myomata in growing in the shape of a polypus and projecting into the canal; in the second it extends around the wall, thickening it and at

<sup>1</sup> *Trans. Path. Soc. Lond.* 1893, vol. xliv. p. 88.

the same time widening the canal. In the polypoid form it is usually of the spindle-celled variety of sarcoma; in the other it is the round-celled.

Primary sarcoma arises generally in the submucous coat; when the coats are invaded from disease of the mesenteric glands, it should be considered secondary involvement, not primary disease of the bowel.

As the growth proceeds it infiltrates all the coats with the exception of the serous, which is but rarely involved. The effect of the infiltration is to produce great thickening, which in some instances leads to increase in the normal calibre of the canal, but in others to encroachment, so that the bowel becomes almost stenosed. At a meeting of the Glasgow Pathological and Clinical Society,<sup>1</sup> illustrations of both these conditions were shown. In the specimen presented by W. J. Fleming and J. Lindsay Steven, the tumour was situated in the first part of the jejunum, and the bowel was dilated in what might be termed the body of the tumour. In the specimen presented by Henry Rutherford, the tumour was situated in the lower part of the ileum, and the canal was so encroached upon by the growth that nothing larger than a No. 8 bougie could be passed. The effect of the extensive infiltration of the gut wall is to convert the bowel into a solid tube. In cases where the tumour mass is very large, and involves also the mesentery, the origin of the tumour may be open to some doubt, as there is as much probability that it may have arisen in the mesenteric glands as in the submucous tissue of the bowel.

Sarcoma is most frequently met with during the third and fourth decades of life. Out of fourteen cases collected by Madelung<sup>2</sup> the youngest patient was 4 years and the oldest 52.

**Symptoms.**—It often happens that general or constitutional symptoms manifest themselves for some time prior to the appearance of local evidences of disease. Thus there is progressive emaciation, loss of appetite, and loss of strength. The patient has a sallow complexion and is cachectic. Local symptoms show themselves by gastric troubles, with ill-defined

<sup>1</sup> *Trans.* 1893, vol. iv. p. 206.

<sup>2</sup> *Centralblatt für Chirurgie*, 1892, No. 30, p. 617.

pain in the abdomen. The bowels become irregular, at one time constipated, at another loose, or, as in Fleming's case, they remain quite regular. In cases where the tumour gives rise to constriction and narrowing of the canal there may be repeated attacks of obstruction, gradually increasing in severity, as occurred in Rutherford's case. In most instances palpation of the abdomen will reveal the presence of a tumour. It would seem that in some cases the tumour, for some unaccountable reason, may disappear for a time. In Fleming's case this was observed, and in a case recorded by Baltzer<sup>1</sup> the patient stated that for a time the hardness which he had previously felt had disappeared. It is possible that such disappearance is only delusive: that the bowel has altered its position or been overlapped by other coils distended with gas.

The course of the disease is usually rapid. In most cases death follows in about nine months from the commencement of the symptoms.

As already indicated, the small intestine may be secondarily involved. Probably this involvement is most frequent when the disease has its origin in the mesenteric glands. It is, however, met with when the disease has its primary origin in more distant parts. Perry<sup>2</sup> records the infection of the ileum in three separate parts by discoid growths which projected about a quarter of an inch above the mucous membrane. The primary tumour was situated in the right tonsil.

**Treatment.**—Removal of the affected part can alone be of any service. This, however, can only be effected in the early stage of the disease, when the tumour has not by direct extension become adherent to and infiltrated other parts. Baltzer,<sup>3</sup> out of thirteen cases which he collected, reports upon four which were operated upon by excision. Two died within twenty-four hours of the operation, and two recovered.

For any further details of this disease the reader should consult the two papers of Madelung and Baltzer, which contain all the most recent references to the subject.

*Lymphoma, Lymphadenoma.*—This kind of tumour practically belongs to the class of sarcomata, and probably in many

<sup>1</sup> *Archiv für klin. Chir.* 1892, vol. xliv. p. 729.

<sup>2</sup> *Trans. Path. Soc. Lond.* 1893, vol. xlv. p. 89.

<sup>3</sup> *Archiv für klin. Chir.* 1892, vol. xlv. p. 749.

instances is described as such. In structure it consists of very small round cells contained in the meshes of a delicate network of fibrils.

When arising in the bowel wall, the tumour causes changes indistinguishable from those just described in the case of sarcoma. The lumen of the canal may be increased. The tumour may form a considerable mass, and does not tend to degenerate.

Taylor<sup>1</sup> recorded a case of a tumour which involved nine inches of the jejunum, the lumen of which was increased in diameter. The mass measured seven by six inches transversely, and two inches in thickness. The tumour could be felt in the abdomen. The patient's symptoms were slight; he suffered occasionally from griping pain, with frequent but not loose motions.

---

## CHAPTER L

### 8. EXTERNAL PRESSURE. 9. PERITONITIS, ENTERITIS. 10. CONGENITAL ABNORMALITIES, MALDEVELOPMENTS. NEUROSES

**8. Pressure upon the small and large intestine from without.** Pressure upon the bowel in order to produce symptoms must narrow its lumen, and the diminution so effected results in obstruction. Two factors of primary importance in the production of obstruction by external pressure are immobility of the bowel and counter-resistance. Hence it is found that the upper part of the jejunum and the duodenum, the cæcum, the sigmoid flexure, and the rectum below, being the parts most fixed and most protected around by resistant bony and cartilaginous walls, are the regions of the intestinal canal most frequently obstructed from external pressure by tumours and abscesses.

Tumours arising within the pelvic cavity are specially prone to produce pressure on the rectum. Numerous examples of such tumours are found in connection with the uterus and ovary. Croft<sup>2</sup> reports a case of acute obstruction produced

<sup>1</sup> *Trans. Path. Soc. Lond.* 1877, vol. xxviii. p. 135.

<sup>2</sup> *Annual of the Universal Medical Sciences*, 1893, vol. iii. C—55.

by pressure of an ovarian cystoma. After removal of the growth all symptoms disappeared. Ricard<sup>1</sup> reports a case of pressure produced by a dermoid cyst of the ovary. At a Branch meeting of the British Medical Association in Birmingham, Kauffmann<sup>2</sup> showed specimens of the ovary and uterus taken from a patient who died of rupture of the large intestine with fæcal extravasation. There was cancer of the ovary and multiple fibromata of the uterus. The entire mass had blocked the sigmoid flexure and produced complete obstruction.

In some instances a tumour, when of a malignant nature, tends not only to obstruct by pressure, but invades also the walls of the gut. In a case recorded by Meyer,<sup>3</sup> the tumour extended from the abdominal wall. It has also been indicated how sarcoma arising within mesenteric glands is liable to extend to the bowel, press upon the canal and invade its coats.

Solid tumours arising from any organ within the abdomen are more liable to produce pressure than cysts or abscesses. Nevertheless examples of the latter are occasionally met with. Aly<sup>4</sup> records a case where the pressure was produced by an abscess originating in a peritoneal gland; and Lucas-Championnière<sup>5</sup> operated upon a case where the pressure resulted from a mass of effused blood after laparotomy: the symptoms appeared on the eighth day after the operation.

Greig Smith<sup>6</sup> records an interesting case of pressure by a tumour, at first thought to be malignant, but which subsequently disappeared. It extended upwards from the pelvis towards the umbilicus and pressed upon the ileum. The symptoms of obstruction were not very acute at first, but gradually became so; the abdomen was much distended, peristalsis was visible, there was vomiting and intermittent pain occurring daily, usually in the afternoon and evening.

**Symptoms.**—It is unusual for symptoms of obstruction to

<sup>1</sup> *Annual of the Universal Medical Sciences*, 1892, vol. iii. C—61.

<sup>2</sup> *Brit. Med. Journ.* 1895, vol. i. p. 702.

<sup>3</sup> *Annals of Surgery*, 1895, vol. xxi. p. 73.

<sup>4</sup> *Annual of the Universal Medical Sciences*, 1888, vol. i. p. 357.

<sup>5</sup> *Revue de Chirurgie*, 1892, p. 264.

<sup>6</sup> *Lancet*, 1891, vol. i. p. 646.



arise from external pressure without its being known that a swelling or tumour liable to produce such obstruction exists. In other words, before a tumour is likely to produce pressure sufficiently great to cause obstruction, it will have rendered its existence perceptible either to the eye or to the hand. The diagnosis therefore of the true cause is frequently not difficult. Although the obstruction may be complete, the symptoms are not ushered in with the same degree of acuteness as is the case in many other forms of obstruction; nor throughout their course are they so urgent. Pain is chiefly paroxysmal and not severe. Vomiting is not incessant. There is abdominal distension with visible peristalsis. The intermittency of the symptoms, especially at the outset, is due to the fact that the increased *vis a tergo* occasionally overcomes somewhat the external pressure, so that some temporary relief is obtained. The more persistent and urgent the symptoms, the more complete must be considered the obstruction.

**Treatment.**—Removal of the cause of pressure will in most instances be followed by relief of the symptoms. When, however, the gut has been invaded or become inseparably adherent, it will be necessary to remove the part concerned at the same time. Meyer succeeded in his case in effecting anastomosis by Murphy's button, after removing the tumour and adherent gut in one piece.

9. **Peritonitis and enteritis.**—Inflammation affecting the bowel itself or derived from without, as in the case of peritonitis, leads to obstruction. As Wilks tersely expresses it, 'an inflamed bowel is a paralysed bowel,' and a paralysed segment of bowel acts as an effectual barrier to the onward progress of its contents.

When obstruction arises from peritonitis, the cause itself is sufficiently grave to mask the prominence of symptoms which owe their origin directly to the obstruction. It would be better to say that the symptoms of obstruction are those of peritonitis; and for that reason it frequently becomes a matter of great difficulty in diagnosis to determine in certain cases whether we are dealing with peritonitis as a primary disease or with obstruction from some mechanical cause.

The symptoms of uncomplicated peritonitis need not be entered upon at any great length here ; in most respects they resemble those which have already been frequently alluded to as occurring in peritonitis the result of injuries and diseases of the intestines. Most prominently stands out the pain which is felt, frequently first at the lower part, although no region is exempt from it at the outset. It may be of a pinching, aching, burning, or cutting character, and is increased by pressure or by movement. The patient's attitude with regard to the pain is somewhat characteristic. If moving about or sitting, he stoops ; if in bed he lies on his back with his head and shoulders raised and his knees and thighs flexed. Every effort is made to relax the abdominal parietes and protect the parts from pressure. The abdominal muscles become fixed, and any attempt to palpate the part increases the rigidity. There is usually some fever, with all the various concomitants which generally attend rise of temperature. Vomiting is frequently present.

Peritonitis, as frequently pointed out, is extremely variable in its symptoms. The exact converse of one case may be found in another. Temperature, in place of being high, may be low : instead of a hot flushed face, pallor with cold perspiration : in place of a rigid abdomen, a lax one with little or no pain ; while the bowels instead of being confined are loose, with an approach in some cases to diarrhœa.

Enteritis, which in some respects much resembles peritonitis, does not as a rule come under the observation of the surgeon in its early stages ; and as it has already been referred to, no further mention of it need be made here. (See page 301.)

**10. Congenital abnormalities, maldevelopments.**—By far the largest number of malformations of the small intestine are connected in some way with the vitelline duct. Either this has remained patent, or its too complete obliteration has resulted in stricture. Between these two extremes there is every grade of maldevelopment.

Hudson<sup>1</sup> has adopted the following useful classification of malformations based on variations found in the develop-

<sup>1</sup> *Trans. Path. Soc. Lond.* 1889, vol. xl. p. 98.

ment of the vitelline duct. The cases are divided into two groups.

In the first group are—

(1) Cases in which the ileum opens freely at the umbilicus, and the chief part of the evacuations of the bowel is discharged by this fistula.

(2) Cases with a small fistulous opening at the umbilicus, admitting a probe and occasionally allowing the passage of faeces and flatus.

(3) A tubular prolongation of the ileum, connected with the umbilicus, either directly or by a longer or shorter fibrous cord.

(4) A fibrous cord connecting otherwise normal intestine or mesentery with the umbilicus.

(5) Meckel's diverticulum, of variable length and shape, either terminating in a rounded extremity or hammer-shaped dilatation.

(6) Slight saccular pouching of the intestine in this region.

In the second group are included instances of excessive obliteration of the duct where the lumen of the bowel has become involved, arranged as follows:

(1) Slight constriction of the gut, with more or less obvious diminution of its calibre, and but few changes above or below.

(2) Marked stricture, causing secondary changes due to dilatation of the gut above, and producing signs of obstruction.

(3) Complete occlusion of the gut by a septum formed of mucous membrane, the muscular and serous coats remaining continuous.

(4) Complete solution of continuity of the ileum.

In addition to the malformations connected with this particular part of the ileum, other congenital defects are met with in the jejunum. Turner<sup>1</sup> showed, at the Pathological Society of London, a specimen of occlusion of about an inch of the middle part of the jejunum. It was shut off from the parts above and below by membranous diaphragms. The occluded portion contained a small quantity of mucous secretion which could not be pushed past either boundary. The specimen was obtained from the body of a small wasted infant aged

<sup>1</sup> *Trans.* 1887, vol. xxxviii. p. 145.

4 days. Another case is reported by Thomas,<sup>1</sup> where laparotomy was performed for complete obstruction in an infant 5 days old. At the post mortem the jejunum was found to end in a blind extremity about thirty-two inches from the pylorus. A somewhat similar instance is reported by Thomson.<sup>2</sup> The child lived for ten days; and at the post mortem, the jejunum, a few inches from the duodenum, was found to end in an abrupt rounded extremity, a gap existing between it and the next portion of the bowel. Willet<sup>3</sup> records two instances, one where the occlusion was at the junction of the duodenum and the jejunum, and the other about the junction of the jejunum and the ileum.

In illustration of Hudson's second group of cases are three of imperforate ileum recorded by Sutton.<sup>4</sup>

The subject of congenital stricture has already been alluded to, and Rolleston's case (see page 397) may be referred to again here, as probably illustrating maldevelopment of the valvulæ conniventes of the jejunum.

A rare malformation is described and depicted by Buzzi,<sup>5</sup> of a diverticulum of the jejunum. It was found in the body of a man aged 77 years, and was situated about three feet from the duodenum.

Of anatomical rather than pathological interest is the transposition of the intestines. Dexter<sup>6</sup> records a specimen, found in the dissecting room, of the sigmoid having a long mesentery and lying in the right iliac fossa, while the coils of the small intestine were alone found in the left iliac fossa. (See also Malformations of Large Intestine.)

**Symptoms.**—Many of these congenital defects are purely of pathological interest, and are found more among the records of the pathologist than of the clinician. On the other hand, cases are sufficiently numerous to show that not infrequently they are a source of grave trouble.

Nothing further need be said here regarding the mode i

<sup>1</sup> *Brit. Med. Journ.* 1886, vol. ii. p. 925.

<sup>2</sup> *Edinburgh Med. Journ.* 1892, vol. xxxvii. p. 840.

<sup>3</sup> *Trans. Path. Soc. Lond.* 1894, vol. xlv. p. 80.

<sup>4</sup> *International Journal of the Medical Sciences*, 1889, N.S. vol. xcvi. p. 457.

<sup>5</sup> *Virchow's Archiv*, 1885, vol. c. p. 357.

<sup>6</sup> *Boston Med. and Surg. Journ.* 1893, vol. xxix. p. 479.

which a diverticulum or its ligamentous remnant is capable of strangulating a loop of bowel; nor is it necessary to repeat what has already been stated regarding the symptoms connected with congenital stricture.

Complete occlusion of the bowel, such for instance as exists in cases where the proximal extremity ends in a cul-de-sac, gives rise to symptoms shortly after the birth of the child.

At first the child may readily take the breast, but vomiting soon sets in, and it is found that everything taken is rapidly returned. Nothing is passed by the bowel except a little mucus. In Thomson's case where the jejunum terminated in a blind extremity a little below the duodenum, some half-teaspoonful of dark green matter, homogeneous and slimy, was passed. As a rule, however, it is not easy to mistake the comparatively small quantity of slimy material ejected, with the normal meconium which should be excreted.

Distension of the abdomen is not seen at first, but in the course of a day or two it appears and forms a marked feature in the emaciated condition of other parts of the body.

It is never possible to predict with any degree of certainty in what region of the bowel the occlusion exists, whether in the duodenum, the jejunum, or the ileum.

The number of days which an infant with complete obstruction is likely to live varies, and depends probably more upon the natural vigour and vitality of the child than upon the situation of the obstruction. In Thomson's case where the obstruction was high up, death resulted on the tenth day; while in one of Hudson's cases, where the occlusion was low down—sixteen inches above the cæcum—death occurred on the third day. The opposite might naturally have been expected if life depended upon the distance of the obstruction from the stomach.

**Treatment.**—The only possible measure in the treatment of obstruction from occlusion is laparotomy and the formation of an artificial anus. This has been attempted several times; and if it has not been the means of hastening death, it has not yet apparently been successful in prolonging life.

The only other congenital defect which comes under the surgeon's observation and treatment is that associated with incomplete closure of the vitelline duct. As already pointed out, this condition may exist in the extreme form of an abnormal anus at the umbilicus, where practically all the fæces are discharged ; or merely as a fistula through which a small quantity of mucus or fæcal matter exudes.

The former, the much graver of the two conditions, will probably need some plastic operation for its cure. There are two advantages, however, in delaying any operative interference. The first is, that young infants do not bear operations well, and the second, that there is the possibility of the aperture closing. If the umbilical orifice has shown distinct evidence of contraction, it may prove possible to complete the occlusion by the application of the actual cautery to its edges. This measure is, however, rarely successful, and a plastic operation of the nature of transplantation of a skin flap may be required.

In cases of the second and less severe kind of fæcal fistula, it frequently happens that evidences of a fistula are not manifest until a few days after birth ; that is to say, until the time of usual separation of the cord, about the fifth or sixth day. The orifice of the fistula is then sometimes marked by a little red vascular papilla or polypus, at the base of which a small opening exists, which admits of the insertion of a probe for a variable distance. In not a few instances these fistulae close in the course of a few days. Should they remain patent the canal may be cauterised, or, if necessary, a plastic operation performed.

**Intestinal neuroses.**—There occasionally come under the observation of the surgeon cases of intestinal disturbance which appear to have their origin either in some purely mental aberration or in some local nerve irregularity. Among the former are cases of supposed ingestion of a foreign body, when the patient imagines he feels the body within the abdomen. In some instances a live animal, such as a snake moving about, is complained of. The symptoms are sometimes very distressing. The patient complains of acute discomfort and pain, vomits, and refuses food.

In instances of local nerve disturbance a particular seg-

ment of bowel, most frequently the sigmoid flexure, undergoes irregular contraction, causing vague and unpleasant sensations in the patient, and sometimes producing tangible evidence of an evanescent tumour in the affected region.

The symptoms in these two classes of cases are probably explained by supposing that the usually imperceptible peristalsis of the bowel becomes consciously observed and felt by the patient, who in many instances is of a highly neurotic temperament.

When these cases are not influenced by medical treatment, laparotomy should be resorted to. Nothing will be found, but in some mysterious way the exploratory operation has a beneficial effect; so much so, that all symptoms suddenly and entirely disappear. Treves<sup>1</sup> has recorded some interesting illustrations of cures after abdominal exploration in this obscure class of cases.

---

## SECTION III

### THE LARGE INTESTINE AND APPENDIX VERMIFORMIS

#### CHAPTER LI

##### ANATOMY AND PHYSIOLOGY

THE large intestine extends from the termination of the ileum in the right iliac region to the anus. It measures from five to six feet in length, and constitutes therefore about one-fifth of the entire length of the intestinal canal. For descriptive purposes it is divided into six separate regions, known respectively as the cæcum, ascending colon, transverse colon, descending colon, sigmoid flexure, and rectum.

*The cæcum.*—This is a large blind pouch constituting the commencement of the colon. It is generally considered as that portion of the latter which is situated below the level of the ileo-cæcal valve (see fig. 56). It lies in the right iliac fossa, and measures, in the adult, about two and a half inches

<sup>1</sup> *Brit. Med. Journ.* 1896, vol. i. p. 2.

both in its vertical and transverse diameters. Posteriorly it rests usually upon the psoas muscle, but if located more externally it lies in contact with the iliacus, or if more internally, on the brim of the pelvis, or even within the pelvic cavity. Separating the muscle from the bowel is the iliac fascia with some fatty and areolar tissue. In front are some coils of the small intestine, but when distended it touches the abdominal wall. The cæcum is entirely surrounded by peritoneum, which admits therefore of a considerable amount of movement of the part. Attached to its lower and hinder part is the vermiform appendix. (For a full description of this appendage see later.)

*The ascending colon.*—Commencing at the cæcum opposite the ileo-cæcal valve, the ascending colon extends upwards to the under surface of the liver, on the right of the gall bladder. It lies in the right lumbar and hypochondriac regions, resting posteriorly upon the quadratus lumborum below and the kidney and descending part of the duodenum above. In front it has the abdominal parietes with some coils of small intestine, which also lie on its inner side. It is surrounded by peritoneum to a somewhat variable extent. It is frequently completely invested, and in some instances to the extent of possessing a meso-colon. According to Treves, in 26 per cent. of cases in which right lumbar colotomy is performed a meso-colon may be expected.

*The transverse colon.*—In the continuation of the ascending into the transverse colon a bend is formed beneath the liver, known as the hepatic flexure. From this point the colon passes across the abdomen from the right to the left hypochondriac region. Its central portion lies on a somewhat lower and anterior level, and occupies a position equally in the epigastric and umbilical regions. By its upper surface it is in contact with the liver and the gall bladder, the stomach and the spleen. Below it are coils of the small bowel. In front it has the great omentum and the abdominal parietes, while behind it is the third portion of the duodenum and the meso-colon. It is practically surrounded by peritoneum, and by its meso-colon is rendered the most movable segment of the large bowel.

*The descending colon.*—As on the opposite side, the transverse



colon connects with the descending colon by a sharp bend. This is situated just below the spleen, and is termed the splenic flexure. From this point the bowel takes a course vertically downwards from the left hypochondriac region, through the left lumbar to the left iliac region. Posteriorly it is connected with the left crus of the diaphragm, the left kidney, and the quadratus lumborum. In front it is covered by coils of the small intestine. According to Treves, this part of the bowel is more frequently surrounded by peritoneum than the corresponding ascending portion; that is to say, a meso-colon may be expected in about 36 per cent. of cases.

*The sigmoid flexure.*—This segment of the large bowel occupies the left iliac fossa, and extends from the crest of the ilium to the sacro-iliac articulation, where it terminates in the rectum. It derives its name from its somewhat peculiar looped disposition. It is concealed by small intestine, but when distended comes into contact with the abdominal parietes. It is surrounded by peritoneum, which forms a meso-colon and serves to retain it in position.

The *rectum*, the remaining portion of the large intestine, will be dealt with separately. (See Part IV.)

**Structure.**—The large intestine, like the small, has four coats—serous, muscular, cellular or submucous, and mucous.

The *serous coat* consists of the peritoneum and surrounds the various segments of the bowel to the extent already described. At certain parts, more particularly in the transverse colon, the serous coat is thrown into a number of small pouches filled with fat, called *appendices epiploicæ*.

The *muscular coat* consists of two layers, an external longitudinal and an internal circular. The former, while it distributes its fibres around the whole circumference, is best marked in the form of three longitudinal flat bands about a quarter to half an inch in width. One, the posterior, is situated along the attached border of the bowel; a second is disposed anteriorly and corresponds along the arch of the colon to the attachment of the great omentum, but lies in front in the ascending and descending colon and the sigmoid flexure; the third is placed laterally, and lies on the inner side of the ascending and descending colon and on the under border of the transverse colon. The shortness of these bands, as compared with the

other structures, serves to throw the canal into a sacculated condition, so that when divided the bowel straightens out into a uniform channel.

The internal circular muscle forms a comparatively thin layer, more or less uniformly distributed, but thickest and best marked over the sacculated portions between the longitudinal bands.

The *cellular, areolar, or submucous coat* resembles the same coat in the small intestine, and serves to connect together the mucous and muscular tunics.

The *mucous membrane* is of a greyish or pale yellow colour, smooth and not thrown into special folds. In its minuter structure the mucous membrane consists of a muscular layer, the *muscularis mucosæ*, of a quantity of retiform tissue in which the vessels ramify, and of a basement membrane which supports epithelium of the columnar shaped variety.

Situated in both the mucous and the submucous coats are two other structures—the *simple follicles* and the *solitary glands*. Both resemble the same structures found in the small intestine. The former, however, are more numerous and closer together. The latter, while scattered irregularly throughout the entire length of the cæcum and colon, are more abundantly distributed in the former.

**Vascular supply.**—The large intestine receives its blood supply from branches of the superior and inferior mesenteric arteries. The cæcum, ascending colon, and transverse colon receive their arterial supply from the ileo-colic, colica-dextra, and colica-media branches of the superior mesenteric; while the descending colon and the sigmoid flexure receive their supply from the colica-sinistra and sigmoid branches of the inferior mesenteric. The final distribution of these vessels to the bowel coats resembles in all respects the course taken by the arteries in the small intestine.

The venous blood is returned by the superior and inferior mesenteric veins, which correspond in their distribution to the same-named arteries. The inferior opens into the splenic vein, while the superior unites with the same vein to form the *vena portæ*. The lymphatics, after leaving the bowel, pass into a chain of glands situated close to the intestinal wall, and are continued from there to other glands situated

along the vascular arches formed by the arteries previous to their distribution. The lymphatics of the cæcum, ascending and transverse colon, after passing through their proper glands, enter the mesenteric glands; while those of the descending colon and sigmoid flexure pass into the lumbar glands.

The **Nerve supply** is derived from the sympathetic. The superior mesenteric plexus, which is a derivative of the great

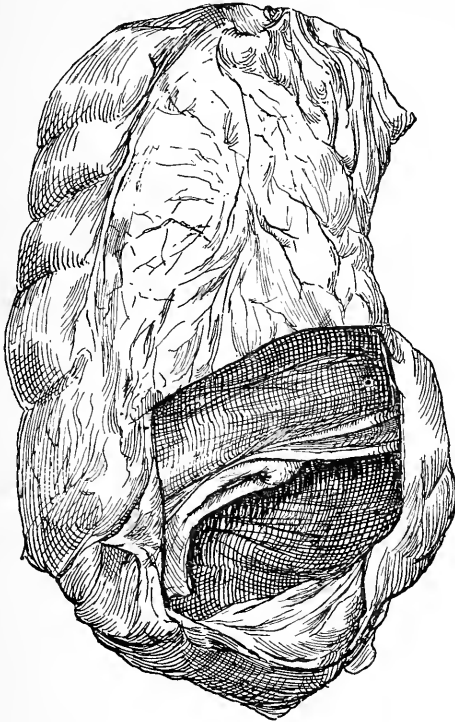

FIG. 56.—ILEO-CÆCAL VALVE. (R.I.M. Glasgow)

The colon opened to show the normal disposition of the valve

solar plexus, supplies filaments to all the branches of the artery of the same name, that is to say, it supplies the cæcum, the ascending and transverse colon; while the remaining portion of the large intestine is supplied by radicles from the inferior mesenteric, itself a derivative of the solar plexus, indirectly through the aortic plexus.

*The ileo-cæcal valve.*—At the junction of the ileum with the cæcum are two reduplicated folds of mucous membrane,

semilunar in shape and so disposed that when their margins are in apposition any regurgitation from the large into the small intestine is prevented (see fig. 56). At the base of the mucous valves is a band of the circular muscle fibres continuous with those of the internal coat of the intestine. The inner surface of each fold is smooth, and continuous with the mucous membrane of the ileum, and, like it, also covered with villi: the outer surfaces, on the other hand, are continuous with the mucous lining of the cæcum, and, like it, devoid of villi.

**Physiology.**—The functions exercised by the large intestine are much the same as those of the small, with such modifications as possibly depend upon the somewhat altered calibre of the canal and the differences in the structure of the mucous membrane. The passage of the contents of the small intestine into the large is followed by a considerable retardation in their progress. A further change is effected in the consistency of the fæces; from a somewhat fluid condition they begin to assume a solid form, due to the absorption of the more liquid portions. Chemical changes take place, whereby the intestinal contents become acid in reaction and develop the peculiar characteristic fæcal odour.

---

## CHAPTER LII

### INJURIES. INFLAMMATION. ULCERATION

COMPARED with those of the small bowel, injuries to the large intestine are much less frequently met with. The difference is most marked in the cases of contusion and rupture; and the reason for this appears to be, first, the anatomical situation of the bowel around the abdominal cavity, and second, the fact that in its intimate structure it is strengthened by longitudinal muscle bands.

Poland<sup>1</sup> has recorded 5 cases of rupture of the large bowel out of a series of 64 fatal cases of rupture of some portion of the intestinal canal; and more recently, Curtis,<sup>2</sup> in a report

<sup>1</sup> *Guy's Hospital Reports*, 1858, 3rd series, vol. iv. p. 164.

<sup>2</sup> *International Journal of the Medical Sciences*, 1887, vol. xciv. p. 329.

of 113 cases, found 4 only in which the large intestine was involved.

As regards the causes of contusion and rupture, their symptoms and treatment, there is nothing to add to what has already been said in the case of like injuries to the small intestine. It is usually not until operation or after death that the exact seat of the lesion is ascertained.

The other injuries, such as punctured and incised wounds, gunshot wounds and lesions arising from the ingestion or presence of foreign bodies, have been treated of in conjunction with the like wounds to the small intestines.

Inflammation of the cæcum—cæcitis or typhlitis—occasionally results from the lodgment of hard fæcal masses. Such inflammation may extend to the surrounding tissues and, if coupled with ulceration and perforation, give rise to fæcal abscesses in the iliac and inguinal regions. Typhlitis in its more extended sense has been taken to include affections of the appendix vermiformis. Inflammation, however, of this latter will receive separate consideration in another place.

**Inflammation.**—Simple inflammation, or colitis, possesses little or no interest to the surgeon. It is only in the more advanced stages of the disease, when inflammation has led to ulceration, that complications not infrequently supervene in which the question of operative intervention arises.

**Ulceration.**—Considerable difficulty attaches to any endeavour to classify non-malignant ulcers of the large bowel. Certain forms, such as the typhoid and the tubercular, are sufficiently distinctive; but many others, in addition to being etiologically obscure, possess neither a pathological nor a clinical basis for classification. It is therefore only possible to treat the subject by discussing each form of ulceration under its predominating feature, whether this be clinical or pathological.

*Simple ulcer.*—It would appear that in not a few instances ulceration of the colon takes place similar in all respects to that which is met with in the stomach and the duodenum; that is to say, the simple chronic ulcer of these regions is occasionally met with in the colon. Like these, also, the ulcer in the colon often perforates, and produces results quite similar. These ulcers may be found in any part of the large bowel.

Occasionally only one large ulcer is present ; but as frequently, in addition to this, smaller ones exist in other parts. Like those in the stomach, no definite cause is known to account for their origin. In some instances the patients have been subjects of Bright's disease ; but they are often found in patients who have been long sufferers from other forms of visceral disease.

Wilks and Moxon<sup>1</sup> consider it probable that these ulcers have the same pathology as varicose ulcers of the leg, that is to say, they are due to some retardation of the venous circulation.

In character they present raised indurated edges, some spreading, while others may be healing. They extend mostly in a transverse direction round the bowel, so that it is possible they may in some instances be the cause of simple cicatricial stenosis.

As illustrations of this form of ulceration and the complications to which it may give rise, the following cases may be quoted :

Parker<sup>2</sup> records two cases of simple ulcer of the colon which in each instance led to the formation of abscess. In one, the case of a woman aged 18 years, a large abscess, which extended over the right ribs from the liver up into the axilla, was found to be connected with an ulcer in the transverse colon. In the other case, that of a woman aged 49 years, a collection of faecal matter and pus extended up in front of the liver to the diaphragm. It was connected with a circular ulcer in the caecum. In neither of these cases was any cause for the ulceration discoverable. In a case reported by Oliver,<sup>3</sup> the ulcer perforated and caused death from acute general peritonitis. The ulcer appeared perfectly clean, it measured two inches in the length of the gut and one inch transversely. It perforated, but the contents of the bowel were at first confined in a small cavity formed by the anterior surface of the left broad ligament, the left border of the uterus, the anterior and left walls of the pelvis, and a somewhat long sigmoid. The abscess subsequently ruptured, causing the peritonitis of which the patient died. In a second case<sup>4</sup> reported by

<sup>1</sup> *Pathological Anatomy*, 2nd edit. p. 409.

<sup>2</sup> *St. Bartholomew's Hospital Reports*, 1887, vol. xxiii. p. 213.

<sup>3</sup> *Lancet*, 1891, vol. ii. p. 122.

<sup>4</sup> *Ibid.* 1885, vol. i. p. 424.

the same surgeon, two ulcers were discovered side by side, placed longitudinally in the large intestine, two and a half inches above the ileo-cæcal valve. The larger measured about half an inch in diameter, the other would admit the tip of a goose quill. Both ulcers had perforated, the orifices presenting round and regular margins.

CASE LXXXIX.—*Simple ulcer of sigmoid flexure.*

A man aged 68 years had for some months been in a debilitated condition, with no other symptoms than that he had passed blood *per rectum*. The hæmorrhage became more frequent, and blood was passed several times during the day. An inguinal colotomy was performed, when it was found that the cause of the hæmorrhage was a large ulcer, about two inches by one inch, in the long axis of the bowel and over the free side of the gut. The base of the ulcer appeared to be peritoneum only. At the post mortem, several small ulcers with punched-out edges were found on the mucous membrane from the middle of the rectum to the middle of the transverse colon. There were contracted granular kidneys. (Robinson, 'Trans. Path. Soc. Lond.' 1891, vol. xlii. p. 115.)

**Symptoms and Treatment.**—The cases are too few and too obscure in their symptoms to admit of being diagnosed during life. The presence of blood in the motions, with the absence of any other obvious bowel symptoms or general constitutional disturbance, might admit of the supposition of simple ulceration of the colon.

The failure of any medicinal or conservative measures to check the hæmorrhage, and the increasing debility of the patient, would reasonably admit of some operative investigation; such as, for instance, was attempted in Robinson's case. Any other operative measures employed in dealing with the ulcer, if happily found and exposed, would resemble those suggested and practised in the case of simple chronic ulcer of the stomach.

*Typhoid ulcer.*—Ulceration of the colon in typhoid fever, while rare as compared with its occurrence in the small bowel, is occasionally met with, and cases are recorded where perforation has taken place. Hadden<sup>1</sup> records one such case, where a round perforation an eighth of an inch in diameter existed in the sigmoid flexure. The entire large intestine was ulcerated to an extreme degree as low down as

<sup>1</sup> *Trans. Path. Soc. Lond.* 1887, vol. xxxviii. p. 145.

the anus. Another case of perforation is recorded by Moore.<sup>1</sup> The 'Transactions' of the London Pathological Society contain the records of many cases, showing to what an extent the large bowel may be involved in ulceration. Curnow<sup>2</sup> showed a specimen where the large bowel was more ulcerated than the small. Coupland<sup>3</sup> also exhibited a specimen to demonstrate extensive implication of the large intestine.

For the pathological description of these ulcers, see Small Intestine, page 339.

*Tubercular ulcers.*—The large intestine is liable to be extensively involved in tubercular ulceration. This region may be implicated alone, or in conjunction with the small intestine. In a case recorded by Moore,<sup>4</sup> the mucous membrane showed large patches of ulceration throughout its entire length; the only other tubercular disease present was in the right lung, from which the patient died. In another case, reported by Hale White,<sup>5</sup> the interior of the cæcum was converted into an enormous tubercular ulcer.

These ulcers resemble in all pathological respects those found in the small intestine, and, like them, are liable to heal and form a stricture, or progress until they perforate.

**Symptoms and Treatment.**—Tubercular ulceration of the large intestine causes symptoms which will be found better discussed in works on medicine. They appear to be variable. Sometimes there is constipation, but there may be intractable diarrhœa, and in other cases there is entire absence of any bowel trouble.

It is rarely that surgical intervention is called for; nevertheless, portions of the large intestine have been successfully excised for tubercular disease. In a case recorded by Körte,<sup>6</sup> the cæcum and a considerable portion of the colon were removed, the patient recovering.

Sachs<sup>7</sup> also reports a successful case of extirpation in a woman aged 41 years; and in an article upon the subject refers to other cases by Hofmohl, Billroth, Gussenbauer, and Czerny.

<sup>1</sup> *Trans. Path. Soc. Lond.* 1882, vol. xxxiii. p. 150.

<sup>2</sup> *Ibid.* 1883, vol. xxxiv. p. 116.

<sup>3</sup> *Ibid.* 1884, vol. xxxv. p. 209.

<sup>4</sup> *Ibid.* 1894, vol. xlv. p. 81.

<sup>5</sup> *Ibid.* 1885, vol. xxxvi. p. 198.

<sup>6</sup> *Annals of Surgery*, 1895, vol. xxi. p. 119.

<sup>7</sup> *Archives Générales de Médecine*, 1892, vol. ii. p. 561.



*Dysenteric ulcer.*—Ulceration the result of dysentery is most frequently met with in the rectum, but any portion of the large bowel may be implicated. It is usual for the lower part to be more extensively affected than the upper.

Considerable variation exists in the size, shape, and arrangement of the ulcers. In some cases they are circular and distinct, while in others they occur in irregular groups. In others, again, extensive areas are involved, so that small isolated patches of mucous membrane are seen projecting from the surface.

The surgical aspects of the disease exist in the complications which may arise in the course of the disease or subsequently. Thus perforation may take place or peritonitis arise from extension of the inflammation to the peritoneum. Severe hæmorrhage occasionally happens, and stricture may result from the healing and contraction of a large ulcerated surface.

*General ulcerative colitis.*—Cases occasionally come before the physician of extensive ulceration of the colon, a disease which appears to run an uninterrupted fatal course. The mucous membrane of the bowel is in some places completely destroyed, while in others islets or tags are left which have the appearance of small polypi. As the result of an examination of twenty cases by Tooth,<sup>1</sup> the following are some of the clinical facts brought out.

Females are more frequently attacked than males, and the average age at which the disease appears is about 31 years in the female and 43 in the male. There are apparently no prodromal symptoms, nor does there seem to be any predisposing cause; in nearly all the cases the patients appear to have been in good health at the time of onset. The disease commences like an ordinary attack of summer diarrhœa. The patient passes motions several times a day; these frequently contain blood, and occasionally sloughs. The stools are not of a dysenteric character. There is little or no fever, and only occasionally some pain. Rapid emaciation takes place, and death ensues usually in from four to ten weeks. Perforation but rarely occurs. At the post mortem, little else than ulceration of the large intestine is met with. The kidneys in some instances have shown evidence of disease; and it is maintained

<sup>1</sup> *Trans. Path. Soc. Lond.* 1894, vol. xlv. p. 66.

by some that the condition is a frequent concomitant of Bright's disease. Cases have been recorded by Pitt,<sup>1</sup> Allchin,<sup>2</sup> Hale White (a record of eleven cases),<sup>3</sup> Ormerod (two cases),<sup>4</sup> and Sharkey (three cases).<sup>5</sup>

This disease, while usually deemed of a purely medical character, is introduced here because surgical intervention seems a not unreasonable consideration in discussing the subject of treatment.

It is sufficiently known to surgeons that ulceration on the surface of the body from whatever cause is always greatly benefited by the simple enforcement of rest and the local application of cleansing agents. It seems therefore quite reasonable to hope that if such measures could be carried out in the case of the large bowel, some improvement might be looked for.

The initiative in this line of treatment seems to have been taken by Mayo Robson,<sup>6</sup> and to have been carried out with good success in a case which is recorded as one of ulcerative or membranous colitis. Various kinds of medical treatment had been adopted without avail. An inguinal colostomy was then performed, and the ulcerated surfaces of the colon irrigated with boracic solution from the anus to the artificial opening, and *vice versa*. The patient was apparently cured. More recently Hale White and Golding-Bird<sup>7</sup> report the successful treatment by colostomy of a case of membranous colitis.

*Ulcer from obstruction.*—As the result of obstructive disease, whether due to simple or malignant stricture, ulcers frequently form in some part of the bowel above the obstruction. The commonest seats are immediately above the obstruction and in the cæcum. It is a common occurrence to find in obstructive disease of the sigmoid flexure one or more large ulcers in the cæcum tending towards perforation.

In what particular way ulceration is caused is not known, but Goodhart<sup>8</sup> thinks it possibly due to one of two influences.

<sup>1</sup> *Trans. Path. Soc. Lond.* 1885, vol. xxxvi. pp. 199, 209.

<sup>2</sup> *Ibid.*

<sup>3</sup> *Guy's Hospital Reports*, 1888, 3rd series, vol. xxx. p. 131.

<sup>4</sup> *Trans. Path. Soc. Lond.* 1889, vol. xl. p. 109.

<sup>5</sup> *Ibid.* 1891, vol. xlii. p. 109.

<sup>6</sup> *Trans. Clin. Soc. Lond.* 1893, vol. xxvi. p. 213.

<sup>7</sup> *Brit. Med. Journ.* 1895, vol. ii. p. 1559.

<sup>8</sup> *Trans. Path. Soc. Lond.* 1880, vol. xxxi. p. 113.

‘ Either the over-distension leads to stretching and narrowing of the blood channels, and so to gangrene ; or else the material retained acts as an irritant and leads to ulcerative inflammation.’

These ulcers occasionally perforate and cause peritonitis. If, however, adhesions have formed between the floor of the ulcer and other parts, an abscess may develop which, bursting externally through the skin, or internally into another portion of the intestinal canal, may result in the formation of a fistula. Such a result may, in some instances, lead to more or less temporary relief of the obstructive symptoms.

In cases of obstruction from fæcal accumulation, small patches of mucous membrane frequently necrose, and on separation leave lesions which are known as *stercoral ulcers*. These ulcers vary in size and number, and are most frequently met with in the cæcum. By extension they may lead to chronic local peritonitis with adhesions, or even perforate and cause acute peritonitis. In some cases they heal, and if originally of sufficient size and extent, they may result in stricture. It is rarely possible to determine the existence of stercoral ulcers. The cause which has given rise to them generally masks any symptoms which might otherwise indicate their existence. A sudden attack of acute pain, sufficient to produce prostration, occurring in a case of chronic constipation would probably indicate rupture or perforation of such an ulcer.

*Ulceration following upon lesions of the spinal cord.*—In deaths from fracture of the spine and from pathogenic lesions of the cord, ulcer has occasionally been found in the large bowel. Targett,<sup>1</sup> at the Pathological Society of London, showed a specimen taken from a case where death followed upon fracture, and alludes to cases observed in connection with death from disease of the cord.

*Syphilitic ulcers.*—These are occasionally met with in the large bowel, and probably result from the breaking down of gummata situated in the submucous tissue. Their commonest seat is in the rectum, where their pathological features will be more fully described.

*Catarrhal ulcers.*—These are found mostly in the colon,

<sup>1</sup> *Trans.* 1892, vol. xliii. p. 73.

and are associated with an acute or chronic inflammatory condition of the mucous membrane. Existing at first as simple isolated erosions of the surface, they may extend and embrace considerable areas of surface. A form of ulceration known as follicular is probably of a character similar to, if not the same as, that due to catarrh of the mucous membrane. Associated with this kind of inflammation is the presence in some cases of a fibrous-like deposit on the surface of the mucous membrane. Where this extends to any degree, complete casts of the bowel are found. The disease under such circumstances is sometimes termed membranous, pellicular, or diphtheritic colitis. Sellew<sup>1</sup> records a case where, after death from laryngeal diphtheria, the large bowel from the anus to the cæcum was lined with a membrane corresponding to that found lining the larynx and pharynx.

---

## CHAPTER LIII

### NON-MALIGNANT OR CICATRICIAL STRICTURE

THIS form of stricture owes its origin to causes similar to those which induce the same condition in the small bowel. Independently of ulceration it is probable that no other initial lesion exists for the production of stenosis. The kinds of ulcer the healing of which are liable to cause stricture, are the tubercular, the simple or chronic, the dysenteric, and the stercoral. But which of these may be the cause in any particular case of stricture it is often impossible to say, although the early history of the case may in some instances give a clue. Thus an attack of dysentery, or evidences, in some form, of tubercular disease, or of chronic constipation, may indicate the nature of the ulcer which has given rise to the subsequent symptoms of stricture.

Of thirteen cases of simple stricture collected by Treves,<sup>2</sup> eleven occurred in females and only two in males. The youngest patient was aged 19 years, while the oldest was 76

<sup>1</sup> *New York Medical Record*, 1889, vol. xxxv. p. 444.

<sup>2</sup> Page 286.

years, and the average age of the thirteen cases 44 years. In another case<sup>1</sup> subsequently reported by the same author, the stricture, which was situated at the junction of the cæcum and ascending colon, formed a hard, rigid, circular ring which just admitted the tip of the little finger. The case was that of a boy aged 15 years, who, for six months previous to his admission to hospital, had been troubled with diarrhœa, followed by gradually increasing constipation with colic, and later with nausea and sickness. The symptoms of obstruction became more and more marked, and the patient rapidly lost flesh and strength. Finally a comparatively acute attack supervened, for which the bowel was opened. Death ensued a few hours after. D. N. Knox<sup>2</sup> reported a case of stricture of the splenic flexure of the colon in a woman aged 49 years. Her symptoms extended over a period of six weeks, when she became suddenly much worse and died from perforation. In a case which I<sup>3</sup> have recorded—that of a girl—an abscess in the abdominal parietes communicated with the dilated portion of the transverse colon in front of a stricture of the splenic flexure. Numerous strictures of varying tightness existed throughout the bowel, and also several circumferential ulcers in various stages of cicatrisation.

There is no constancy in the period which intervenes between the stage of ulceration and the resulting cicatrix, nor in the form of the stenosis which follows any particular disease. In regard to the former an interval of months or years may exist between the initial lesion and the symptoms resulting from subsequent stricture; while in the latter, symptoms of obstruction are only likely to arise where the preceding ulceration has extended for a considerable distance circumferentially round the bowel. Thus it happens that strictures of the bowel are more frequent as pathological than as clinical observations. In a case recorded by Rolleston,<sup>4</sup> three constrictions were found at the post mortem, one just above the cæcum, a second at the hepatic flexure, and a third in the sigmoid flexure. The patient had caries of the spine, but was in no way troubled with his bowels.

<sup>1</sup> *Trans. Path. Soc. Lond.*, 1888, vol. xxxix. p. 113.

<sup>2</sup> *Glasgow Med. Journ.* 1887, N.S. vol. xxviii. p. 141.

<sup>3</sup> *Trans. Path. and Clin. Soc. Glasgow*, 1892, vol. iii. p. 37.

<sup>4</sup> *Trans. Path. Soc. Lond.* 1890 vol. xli. p. 131

The very limited number of cases recorded does not admit of any statement as to the relative frequency of stricture in one region as compared with another. No part, from the ileo-cæcal valve to the lower end of the sigmoid flexure, appears to be exempt.

**Symptoms.**—Considerable variation exists in the symptoms consequent on stenosis of the large bowel. Thus it may be said that the nearer the seat of stricture to the small bowel, the more do the symptoms approach those dependent upon a similar involvement of the latter; while, on the other hand, the nearer the constriction to the lower end of the sigmoid flexure, the more the symptoms resemble those of stricture of the rectum.

The earliest symptom to manifest itself is usually constipation, which, as it increases, frequently requires the use of purgatives. The motions are usually well formed, any alteration in shape indicates a stricture low down in the rectum. Associated with the need of relief are attacks of paroxysmal or colicky pains, which subside so soon as the bowel is unloaded. Not infrequently a temporary attack of diarrhoea supervenes upon the relief of the distended bowel.

Sooner or later an attack of obstruction ensues, with an aggravation of those symptoms which have only been previously suffered from to a slight degree. Thus the paroxysmal pain becomes more marked and more frequent. Aperients may intensify rather than diminish the pain. Tenesmus exists in some cases; while vomiting, limited at first to the contents of the stomach, may or may not prove a prominent feature. The abdomen is noticed to distend, partly as the result of accumulated flatus and partly owing to fæcal distension of the intestine above the stricture. The abdominal parietes are flaccid, and, if thin, may admit of palpation of the distended gut. More particularly does a loaded colon become perceptible when the stricture is situated low down in the sigmoid flexure. During the attacks of paroxysmal pain, the vermicular action of the walls of the distended small intestine may become visible. This state of things may last for some days, when sudden relief of the intestine, through the passage of a large and copious motion, will cause all the

symptoms to subside, and the patient may then for a period return to a state of comparative well-being.

After a variable interval of time, either as the result of some indiscretion in diet or from increased narrowing of the strictured channel, another attack of obstruction ensues, with a repetition of all the previous symptoms. The completeness of the obstruction in this renewed attack may have caused the case to enter upon its last and fatal stage. The vomiting may now assume a stercoraceous character, and the pain, hitherto paroxysmal, become continuous. Death is sometimes ushered in by peritonitis.

The general condition of the patient is usually one of gradually increasing weakness and emaciation. This, however, is not so marked in the earlier stages of the disease. But repeated attacks of obstruction soon undermine the health and strength.

While the above may be taken as an example of the symptoms to be met with in a fairly typical instance, the following, reported by Bartolomé,<sup>1</sup> will illustrate how variable they may prove, even in a case which ends fatally. The patient, a female aged 51 years, had had several attacks of complete constipation; but these usually passed off after a few days and, beyond slight abdominal pain, caused her but little inconvenience. In her last attack, which lasted nineteen and a half days before death ensued, she only suffered, in addition to her complete constipation, from a little bilious vomiting. This, however, on one occasion only, and that two days before death, consisted in a copious stercoraceous ejection which was not repeated. The rectum was extremely patulous, with some prolapse, and admitted the introduction of the hand. She gradually sank. At the post mortem, a stricture was found at the junction of the sigmoid flexure and the rectum.

CASE XC.—*Simple stricture of the sigmoid flexure.*

A man aged 45 years had for two and a half years or more suffered from habitual constipation, which latterly had necessitated the use of purgatives. Diarrhœa at times followed the use of aperients. Prior to the action of the bowels he suffered from griping and colicky pains, with a dull aching about the lower part of the lumbar regions, and after move-

---

<sup>1</sup> *Brit. Med. Journ.* 1886, vol. i. p. 190.

ment, pain and soreness in the abdomen was felt for a couple of hours. At times the motions contained quantities of red or clear gelatinous mucus. Before movement the distended descending colon and sigmoid flexure could be made out, the manipulation causing some feeling of tenderness. He suffered at times from flatulence and abdominal distension. Pain sometimes followed a meal, and on more than one occasion indiscretion in diet led to an attack of obstruction, with peritonitis. He learnt to relieve himself by using injections of water. On the last occasion, however, he appears to have injected either too much or too forcibly, for rupture of the bowel occurred immediately below the stricture, and death followed. At the post mortem, old adhesions were found binding down the rectum, sigmoid flexure, and descending colon. The descending colon above the stricture was packed with fæces. The stricture itself admitted a No. 10 catheter. The rupture was principally below the stricture, but involved it also. The cause of the stricture, so far as could be made out, appeared to have been a simple ulcer. (J. P. Doyle, 'Trans. of the Royal Academy of Medicine in Ireland,' 1892, vol. x. p. 81.)

**Diagnosis.**—The symptoms of stricture of the large intestine sometimes so closely resemble those of the small that differentiation becomes all but impossible. Where, however, a distinction can be drawn, it will be found probably to exist in one or other of the following details.

Attacks of obstruction of the large bowel are less acute. Vomiting is not such a prominent symptom, and is much longer in becoming fæcal. Food rarely causes an attack of pain, and is not necessarily followed by vomiting. Abdominal distension is more marked, and the peristaltic action of the bowel usually visible. Aperients augment rather than diminish the pain. Complete obstruction is much longer in bringing about a fatal result.

In distinguishing between symptoms connected with stricture of the large bowel and those dependent on stenosis of the rectum, not so much difficulty exists, inasmuch as the rectum admits of more or less complete examination by mechanical means. The exact seat of a stricture it is not usually possible to determine, except when it is located in the sigmoid flexure. In this region the injection of water *per rectum* may, according to the amount introduced, convey some idea as to its situation. It must, however, be remembered that the fluid may find its way through the stricture, and so mislead rather than guide. Another symptom, of which more will be said when discussing stricture of the



rectum, is the so-called 'ballooning' of the bowel below the obstruction ; that is to say, the rectum becomes widely dilated from within the anus upwards.

**Treatment.**—Relief of the earlier symptoms will be best effected by a careful attention to diet and proper regulation of the bowel by the administration of mild aperients. As the stricture tightens and temporary attacks of obstruction supervene, the use of copious enemata will likely afford the readiest relief. Violent purges should be avoided ; and, failing any beneficial result from the use of simple aperients, the opposite treatment of rest to the bowel, by giving belladonna and opium, should be tried. When all conservative measures fail, there is nothing but operation to afford relief. The bowel must be opened above the stricture by a right or left colostomy, according to the situation of the obstruction ; and if a left inguinal or lumbar colostomy shows the bowel to be collapsed, the wound should be closed and the ascending colon opened. When the stricture is seated in the cæcum or at the ileo-cæcal valve, enterostomy must be performed. Péan<sup>1</sup> has succeeded in two cases of simple stricture of the ileo-cæcal valve by performing enteroplasty, an operation similar to the pyloroplasty of Heineke and Mikulicz. After withdrawing the part and clamping both ends of the bowel, the strictured valve was divided in the long axis of the gut, and the edges of the wound so formed united transversely. For any further operative measures upon the stricture itself, what has been said on this point in the case of stricture of the small intestine might be repeated here.

It need hardly be indicated that where there is just reason to believe that a patient, in the early stage of the disease, is suffering from simple stricture of the large bowel, early operative intervention holds out the best and possibly the only hope of an ultimate cure.

<sup>1</sup> *Annual of the Universal Medical Sciences*, 1892, ol. iii. C- 69.

## CHAPTER LIV

INTERNAL STRANGULATION. ADHESION, AND KINKING.

INTUSSUSCEPTION. VOLVULUS

THE size, situation, and fixity of the large intestine render it peculiarly exempt from many of those sources so prone to strangulate the small bowel. Treves<sup>1</sup> quotes a case recorded by Trélat, where the sigmoid flexure became strangulated through a slit in the mesentery; and Bennett<sup>2</sup> describes a case of strangulation of part of the ascending colon, together with the ileum, beneath an appendix which had become adherent to the right ovary. The patient in this case had also a stricture of the rectum which would only admit the point of the finger, and a fistulous communication above the stricture with the vagina.

As regards internal hernia, the only situation where the large bowel appears to have been strangulated is through an opening in the diaphragm. In most instances, if not in all, the bowel has passed through a congenital aperture either alone or in conjunction with the stomach and other viscera.

The cases recorded are very few. Smith<sup>3</sup> reports the case of a child, 2 months old, who had suffered from attacks of abdominal pain, each of which was followed by a state of great prostration. The attacks of pain came on at first every other day, but later much more frequently, until death followed from exhaustion. At the post mortem, it was found that in the *ligamentum arcuatum externum* there was a rounded opening of about an inch in diameter. Through this aperture had passed, into the left side of the thorax, the ascending colon, the transverse, the descending, and half of the sigmoid flexure. Schwartz and Rochard<sup>4</sup> record a case where the patient presented all the typical signs of acute intestinal obstruction. Laparotomy was performed, and a careful examination of the abdomen made, but nothing detected. The

<sup>1</sup> Page 53.

<sup>2</sup> *Trans. Path. Soc. Lond.* 1853, vol. iv. p. 146.

<sup>3</sup> *Archives of Pediatrics*, 1887, vol. iv. p. 385.

<sup>4</sup> *Revue de Chirurgie*, 1892, vol. xii. p. 756.

patient died, and at the post mortem a loop of bowel formed by the transverse and descending colon was found to have passed through and become strangulated by an aperture in the diaphragm. In a case of my own, fully reported below, the symptoms also were those of acute intestinal obstruction. In this instance the splenic flexure of the colon was nipped in an aperture in the left expansion of the diaphragm. Through this aperture had passed a mass of omentum, which from its organic connection with the subpleural tissue seemed to indicate that the incarceration had existed for some time. The only clinical feature which could be said to have thrown any true light upon the nature of the obstruction was the sausage-shaped tumour felt in the epigastric and left hypochondriac regions. This, however, proved in reality to be a misleading factor in the diagnosis, as it naturally led to the belief that the tumour was an intussusception. The operation showed it to be the distended transverse colon passing upwards to the diaphragmatic aperture.

CASE XCI.—*Strangulated diaphragmatic hernia: symptoms of acute intestinal obstruction: laparotomy. Death.* (Abstract of report taken by Dr. Alexander MacLennan.)

J. M., a schoolboy aged 8 years, was seized with vomiting on Thursday night, October 31, 1895, shortly after having eaten some nuts and apples. He suffered no abdominal pain at the onset. The following day, Friday, he was given some castor oil, which he vomited. He continued to vomit everything he took on Saturday and Sunday. On Tuesday evening his vomiting became fæcal. Neither flatus nor fæces passed during these days. There was no history of previous disease of, or injury to, the abdomen.

He was admitted into the Victoria Infirmary, under the care of Mr. Maylard, at 7.15 P.M. on Wednesday, November 6—that is, on the sixth day of his symptoms. The boy, when seen, was in a somewhat, though not markedly, collapsed condition, with rapid and feeble pulse. He complained of pain in the left hypochondriac region, where tenderness on palpation was also elicited. The pain, he stated, commenced in the left inguinal region and was spasmodic in character. The colon was evidently distended, as also was the whole abdomen. Nothing was detected by rectal examination, and no blood stain seen on withdrawal of the finger.

*Operation.*—At 8.15 P.M., an hour after his admission, laparotomy was performed. Prior to opening the abdomen, the parts were palpated, when a very well-defined sausage-shaped tumour could be felt in the epigastric region, tapering off somewhat towards the right hypochondrium, but ending abruptly when traced to the left. On opening the peritoneal cavity, distended small bowel presented. On tracing this it was found to lead to the cæcum. This, with the large intestine as far as the splenic flexure,

was enormously distended. At this latter point the bowel took a course upwards and a little backwards to the left. Passing up in the same direction was seen the collapsed descending colon. Examination with the finger then revealed the presence of a small aperture through which the bowel appeared to pass. No traction on the latter would release the intestine until the aperture was dilated. This was effected by gradually insinuating the finger through it, the bowel then becoming easily disengaged. On dilating the anus, gas and fluid fæces at once began to escape. The distended colon was partially relieved by puncturing with the trocar; but the bowel wall appeared lax, and paralysed from prolonged over-distension. The intestines were returned and the abdomen closed. The boy rallied and lived for about twelve hours, when he died from exhaustion. There was a free evacuation from the bowel during the night.

*Post mortem, by Dr. T. K. Monro.*—An opening, three-quarters of an inch in diameter and circular in shape, was found in the left leaf of the diaphragm, close to the left lateral parietes and about on a level with the eighth rib. The diaphragm bounded it all round. A cord of omentum passed through from the cardiac end of the stomach. The omental mass turned inwards on the upper surface of the diaphragm and became embedded in the subpleural connective tissue, with which it was very closely incorporated: appearances suggested an old-standing omental hernia. Both lungs were adherent. No corresponding opening was seen on the opposite side. (Plate XIX, fig. 57.) (A. Ernest Maylard, 'Glasgow Med. Journ.' 1896, vol. xlv. p. 143, and 'Path. and Clin. Soc. Trans. Glasgow,' vol. vi. p. 78.)

**Adhesions.**—Adhesions involving the large bowel to variable degrees are common enough, but it is comparatively rare for such adhesions to cause obstruction similar to that which is not infrequently met with in the case of the small intestine.

The causes which give rise to these adhesions are mostly similar to those already described as affecting the small intestine, and are directly due to local attacks of peritonitis. The commonest cause, however, which originates within the large intestine, is in all probability some form of ulceration. When the ulcer has extended so deeply that its base is formed by little else than peritoneum, inflammation attacks the latter, and adhesions form between the bowel and some neighbouring tissue or organ. As a further result of such a connection, fistulæ may become established with some other viscus, or an abscess may form.

**Kinking.**—The attachment and position of the large intestine render it specially exempt from any acute bending. Instances, however, occasionally occur where it seems probable

PLATE XIX.

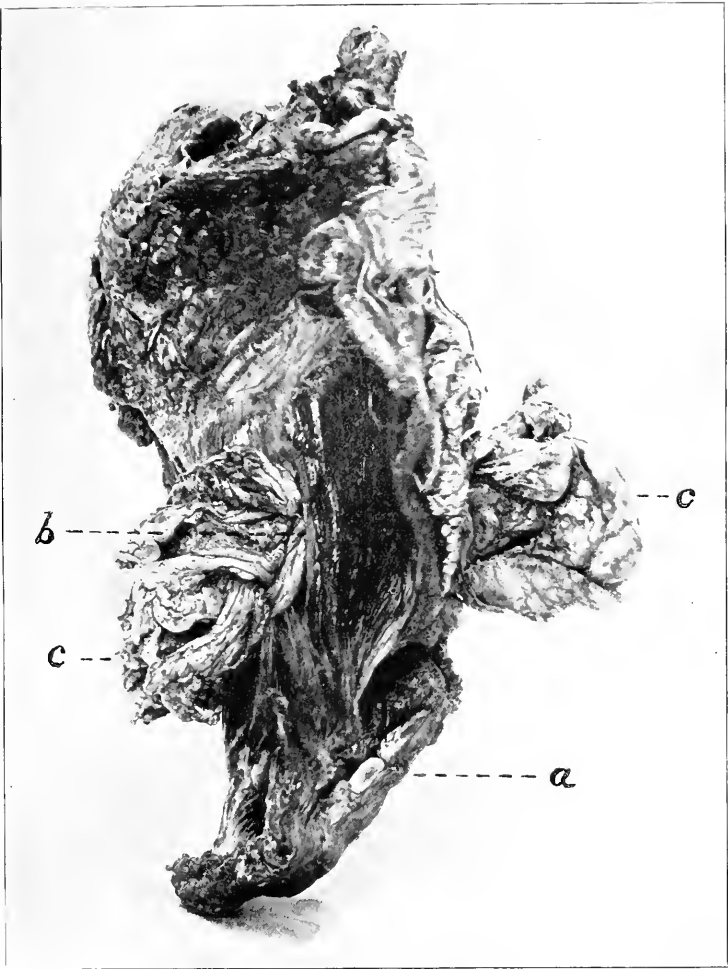

Fig. 57.—DIAPHRAGMATIC HERNIA.—*a*, ribs; *b*, margin of aperture in abdominal aspect of diaphragm; *c c'*, incarcerated omentum passing through diaphragmatic aperture into subpleural tissue. (*V.I.M., Glas.*)



that enormous distension of the colon may be the result of some undue flexion of the sigmoid flexure at its junction with the rectum. Kinking from adhesions, resulting in obstruction, is very rare. A case of the kind is recorded by Shaw.<sup>1</sup> The patient died of acute obstruction, and at the post mortem the following condition was found. Tracing the ascending colon to its highest point, it was seen to return abruptly upon itself and then descend downwards as far as the cæcum, and the two portions lying parallel were firmly united by lymph to each other and the adjoining parts. After forming this loop, the colon ascended and followed its usual course. The internal surface of the colon was extensively ulcerated, and a little beyond the cæcum, at a point where a fold of jejunum adhered, a fistulous communication existed between the two coils.

Another case is recorded by McNutt,<sup>2</sup> in which the colon was found distended to the size of a coat sleeve, the occlusion being due to a kink in the intestine caused by adhesions following peritonitis.

**Intussusception.**—Invagination of one part of the colon into another—that is to say, the colic variety of intussusception—is rare. Out of twenty-seven cases of intussusception collected by Bull and Cohen,<sup>3</sup> which were reported during the year 1894, one only was colic. Cases, however, are recorded from time to time, and from these it would appear that the condition is most frequently met with in adults, and usually owes its cause to some definite local stimulus, such as is furnished by a tumour or stricture. Two cases are reported by Bryant,<sup>4</sup> in both of which the apex of the intussusceptum had a large papillomatous growth attached to it. In two other cases referred to by the same author, the intussusception was associated with malignant disease of the bowel. In another case, recorded by Mayo Robson,<sup>5</sup> the apex of the intussusceptum was formed by a carcinomatous stricture of the descending colon; and in a somewhat similar case, reported by Symonds,<sup>6</sup> the malignant growth was situated in the sigmoid flexure.

<sup>1</sup> *Trans. Path. Soc. Lond.* 1853, vol. iv. p. 147.

<sup>2</sup> *Annual of the Universal Medical Sciences*, 1892, vol. iii. C—60.

<sup>3</sup> *Ibid.* vol. iii. C—24.

<sup>4</sup> *Trans. Med.-Chir. Soc. Lond.* 1894, vol. lxxvii. p. 169.

<sup>5</sup> *Brit. Med. Journ.* 1895, vol. ii. p. 963.      <sup>6</sup> *Ibid.* 1893, vol. i. p. 638.

The intussusception is almost always of the descending variety. An exceptional instance, however, is recorded by Power,<sup>1</sup> where it was of the ascending form. In this case the patient had an ordinary ileo-cæcal intussusception, and in addition a second invagination, about an inch and a half in length, situated in the transverse colon. That this latter, which was of the ascending variety, existed before death, was proved by the contiguous walls of the gut being glued together by recent lymph. Two other similar cases are referred to.

**Symptoms.**—As distinguished from the other forms of intussusception, the symptoms associated with the purely colic variety are much less sudden in their onset and much less rapid and acute in their progress.

In most of these cases the patients have suffered previously from attacks of colic, constipation or diarrhœa, vomiting, and other symptoms indicative of temporary obstruction or intestinal irritation. But in those cases, and they comprise the majority, where prior to the formation of the intussusception there exists an innocent tumour or a malignant growth, the earlier symptoms may be more intimately connected with such lesions. It is usual, however, for the invagination to take place gradually, and so attacks of obstruction may occur from time to time as the direct result of such a process.

When the intussusception becomes a marked feature in the case, it frequently projects into the rectum, and is sometimes protruded through the anus. In such cases it is possible both to feel and probably see the tumour. Tenesmus with the passage of blood and mucus then become pathognomonic symptoms. Further, the typical sausage-shaped tumour may be felt in the left iliac fossa or in some other region of the abdomen.

Complete blockage of the canal occasionally occurs, and when it does so, vomiting sets in, with distension of the abdomen and other symptoms of acute intestinal obstruction.

**Diagnosis.**—As in the case of other forms of intussusception, the presence of a sausage-shaped tumour in the iliac fossa, or felt within the rectum, together with tenesmus and the passage of blood and mucus, are pathognomonic symptoms of the condition.

<sup>1</sup> *Trans. Path. Soc. Lond.* 1886, vol. xxxvii. p. 240.



The chief distinguishing features between this form of intussusception and those where the small intestine is involved are, the age of the patient, the history of antecedent bowel trouble, and the comparatively non-acute progress of the affection. The detection also of a polypus or some malignant growth, forming the apex of the intussusceptum, is almost equally distinctive of involvement of the large bowel.

**Prognosis.**—There is little to hope for without surgical intervention; this is the more true when the cause is some kind of tumour. A case, however, is reported by Sutcliffe<sup>1</sup> where a boy aged 17 years, after suffering for seventeen days from symptoms of obstruction of variable and intermittent degrees of acuteness, passed a sphacelus of bowel thirteen inches in length, seven inches of which represented intact bowel, while the remaining six inches consisted of a ribbon of only half of the circumference of the gut. The presence of unmistakable appendices epiploicæ proved it to be large intestine. Such an instance of natural recovery is quite exceptional; in most cases death will supervene before such time has elapsed as will admit of the natural separation of the intussusceptum.

**Treatment.**—Each case will need to be dealt with on its own merits. In the two cases reported by Bryant, success was obtained by first forcibly dilating the anus, removing the papillomatous growth, and then with the hand inserted into the rectum, pushing up the bowel. It is possible that many surgeons do not possess a hand which measures circumferentially nine and a quarter inches over the knuckles, in which case injection, inflation, or some other simple mechanical measure for pushing up the bowel must be tried. In the case reported by Symonds, the malignant stricture was excised, and the bowel then successfully pushed up. In Mayo Robson's case laparotomy was performed and the intussusception easily reduced by pressure from below. The tumour was then successfully excised.

**Volvulus.**—Twists are more frequently met with in the large bowel than in the small; the predisposing causes are, however, much the same in both. Either there is a congenital malformation in the form of an abnormally long meso-colon, or this latter has become elongated owing to continuous overloading of the bowel, such as is liable to occur

<sup>1</sup> *Brit. Med. Journ.* 1894, vol. ii. p. 124.

in some cases of chronic constipation. Old adhesions may also in some instances prove the initial cause. In a case reported by Bonuzzi,<sup>1</sup> it would appear that the excessive length of the sigmoid flexure—four times its usual size—had predisposed to rotation on its mesenteric axis. Among the most important direct or exciting causes are irregular distribution of the intestinal contents and violent peristalsis.

As regards the seat of the volvulus, the segment most often implicated is the sigmoid flexure, and next to that the cæcum; the transverse colon is but rarely affected. The twisting of any part may take place in one of three ways: the bowel may rotate on its own axis, intertwine with another portion, or twist about an axis formed by its mesentery. In a case reported by Walsham,<sup>2</sup> ‘the cæcum and the beginning of the colon were twisted three times from right to left around the lower four inches of the ileum, forming a corkscrew-like coil, with the cæcum at the apex.’

Volvulus is more frequently met with in males than in females, and usually occurs after middle life.

The result of twisting is to cause obstruction, and certain changes within the affected portion. As regards obstruction, the more complete the twist the more complete the blockage. When a loop of bowel rotates on its mesentery, obstruction is likely to be of an acuter character than when it revolves upon its own axis.

The effect of a twist upon the involved parts depends upon its form and the degree of rotation. When a loop of bowel rotates upon its mesenteric axis to more than a half-turn, the mesenteric vessels become strangulated, and the loop rapidly gets congested, dilates, and subsequently becomes gangrenous. Adhesions are formed and general peritonitis sooner or later sets in. The distension of the involved loop is sometimes considerable. In a case referred to by Wilks and Moxon<sup>3</sup> the loop reached the under surface of the diaphragm. The bowel above the volvulus also becomes distended.

**Symptoms.**—The symptoms are usually those of acute obstruction, with certain features which sometimes render it possible to diagnose the true cause. Thus an important

<sup>1</sup> *Annual of the Universal Medical Sciences*, 1893, vol. i. D—32.

<sup>2</sup> *Trans. Clin. Soc. Lond.* 1888, vol. xxi. p. 139.    <sup>3</sup> *Pathology*, p. 397.

early physical sign is a circumscribed area of tympanites, which corresponds to the distended loop involved, the remaining portion of the abdomen being more or less dull to percussion. When the volvulus is situated in the sigmoid segment, vomiting is not usually a constant symptom. Colicky pains are complained of from the first; and general abdominal distension becomes a marked feature at a later stage.

CASE XCII.—*Volvulus of the sigmoid flexure, successfully reduced after laparotomy.*

Mrs. M., aged 50 years, insane, had suffered from chronic constipation. She was suddenly seized with vomiting and symptoms of acute obstruction of the bowels. There was tympanites, a quick pulse and moderate elevation of temperature. On the evening of the third day, she lay in bed with her knees drawn up, her face pinched, and expression anxious. Pulse 114. Temperature 100°. Her abdomen was exceedingly distended, especially in the centre, where there was a peculiar ovoid enlargement of great size. Later on, the same evening, laparotomy was performed, and on opening the abdomen a huge distended viscus at once presented. It was at first thought to be a greatly distended stomach, but was recognised as the colon by its glandulæ epiploicæ and longitudinal bands. An incision was made into it, and a large quantity of gas and some fluids escaped, sufficient to relieve the distension and allow careful examination, which showed one complete turn of the sigmoid upon itself from left to right. The remaining part of the colon and small intestines was but moderately distended. The confined part of the sigmoid flexure was dark and congested, it having furnished the greater part of the previous abdominal distension. A few Lembert sutures closed the incised bowel, and reduction with replacement was with moderate difficulty accomplished. As soon as the patient had recovered from the anæsthetic ten grains of calomel were administered, followed in a few hours by profuse discharge from the bowels and an uneventful recovery. (William J. Mayo, 'Annals of Surgery,' 1893, vol. xviii. p. 28.)

**Treatment.**—When seen within a few hours of the onset of acute symptoms, copious injections of water should be given with the object of emptying the lower bowel, and, if possible, untwisting the involved loop through distension of its canal. Massage, after the plan advised by Hutchinson, may also be practised. These measures, however, failing, or as a primary resource in cases at a later stage, the abdomen must be opened.

The incision, made in the median line, below the umbilicus, must be of sufficient length to admit of the volvulus being brought outside the wound. If the bowel has not become gangrenous its distension must be relieved by a longitudinal

incision an inch or so in length. This will admit of the escape of gas and fæces, and all due care must be taken, in the suitable arrangement of cloths &c., to prevent any contamination of the peritoneum with the outflowing fæces. The opening in the gut must be closed by Lembert stitches; and after rectifying the position of the bowel, the parts are returned into the abdominal cavity and the parietal wound closed.

In some cases it may happen that considerable distension of the colon and intestines above co-exists and interferes with the replacement of the untwisted loop. It will then be necessary to relieve the distension of these parts in a similar way to that adopted in the case of the loop itself.

It occasionally happens that recurrence takes place; as shown, for instance, in a case reported by Finney,<sup>1</sup> where three years after the first operation a second had to be performed for a repetition of the same condition. In order to prevent such recurrence, therefore, Roux<sup>2</sup> recommends that in case of sigmoid volvulus the meso-colon should be sutured to the abdominal wall. In a case mentioned by Gould,<sup>3</sup> the wall of the gut itself was stitched to the parietes.

When the bowel has become gangrenous, or adhesions have formed, so that it is neither safe nor possible to attempt replacement, further measures must be adopted. In the former case excision of the volvulus is necessary; while in the latter, intestinal anastomosis must be established.

Of successful cases treated by laparotomy the following may be given. McArdle<sup>4</sup> reports having with difficulty untwisted the sigmoid after incising it and washing out the canal with warm water. Senn,<sup>5</sup> Mayo, Ochsner, and Finney<sup>6</sup> have also published successful cases. Benham<sup>7</sup> succeeded in untwisting a volvulus which consisted of the sigmoid twisted a half-turn on itself.

Bryant<sup>8</sup> performed colostomy in a case which proved fatal.

<sup>1</sup> *Brit. Med. Journ. Epitome*, 1893, vol. i. p. 98.

<sup>2</sup> *Centralblatt für Chirurgie*, 1894, vol. xxi. p. 865.

<sup>3</sup> *Brit. Med. Journ.* 1895, vol. i. p. 979.

<sup>4</sup> *Dublin Journal of the Medical Sciences*, 1893, vol. xciv. p. 97.

<sup>5</sup> *Annual of the Universal Medical Sciences*, 1891, vol. iii. C—37.

<sup>6</sup> *Ibid.* 1894, vol. iii. C—26.

<sup>7</sup> *Trans. Clin. Soc. Lond.* 1895, vol. xxviii. p. 180.

<sup>8</sup> *Ibid.* 1888, vol. xxi. p. 142.

## CHAPTER LV

## GALL-STONES, ENTEROLITHS, FÆCAL ACCUMULATION

**Gall-stones.**—It is rarely that the presence of a gall-stone in the large intestine gives rise to symptoms of any moment. Its lodgment for a time in the bowel may cause irritation, but it is exceptional for obstruction to result. A case, however, is recorded by Körte<sup>1</sup> of a woman aged 72 years, who was suddenly seized with symptoms of acute intestinal obstruction the result of a gall-stone impacted in the colon. The bowel was opened and the stone removed, but the patient died.

**Enteroliths.**—Intestinal concretions or calculi have already been alluded to as occurring in the small intestine. They are, however, more frequently met with in the large, where they may exist for an indefinite period without giving rise to symptoms.

In structure and consistence they vary. In some cases they are hard and composed of mineral substances, chiefly phosphatic, combined with animal matter and sometimes cholesterine. In others they are comparatively soft or porous, composed of matted masses of vegetable substances mixed with fæcal matter, the former consisting frequently of undigested ligneous fibres. A third variety exists, which is formed by the aggregation of substances which have been taken for medicinal purposes; such are subnitrate of bismuth, carbonate of magnesia and iron the result of drinking certain chalybeate waters, and chalk.

**Symptoms.**—In the few cases recorded, the symptoms have varied. In a case reported by Mentin,<sup>2</sup> the patient had been a sufferer from intestinal catarrh, for which she had been treated by the internal administration of subnitrate of bismuth. At the post mortem a bean-shaped body was found in the cæcum, composed of subnitrate of bismuth 85 per cent. and of organic substances 15 per cent. There do not appear to have been any symptoms during life suggestive of its presence. On the other hand, in the case narrated below, it will be seen that the symptoms at times were severe, and extended over a period

<sup>1</sup> *Berliner klin. Wochenschrift*, 1893, p. 690.

<sup>2</sup> *Annual of the Universal Medical Sciences*, 1892 vol. i. D—21

of several years. It was possible in this case to feel the enterolith through the abdominal wall.

Hadden<sup>1</sup> reports the case of a girl aged 7 years, who suffered for several months from chronic diarrhoea dependent on intestinal catarrh. She was treated during most of this time with chalk in various forms, and with bismuth. The child died, and at the post mortem nineteen distinct calculi were found in the transverse colon, varying in bulk from the size of a large cherry to that of an orange pip. Their chemical composition consisted of tricalcium phosphate, calcium carbonate, nitrogenous matter, and moisture.

CASE XCIII.—*Two enteroliths in the colon, successfully removed by colotomy*

A woman aged 50 years had suffered from periodic attacks of excruciating pain about the right iliac fossa, recurring once or twice monthly and accompanied by abdominal distension, vomiting, and constipation. The attacks had begun to appear about twenty years before admission to the hospital, and had so increased as to make her totally incapable of work. Her bowels acted quite regularly during the free intervals. Examination of the abdomen revealed the presence of two hard, smooth, globular tumours situated one above the other, somewhat downward and to the right of the umbilicus, the upper being as large as an orange, the lower about the size of a hen's egg. The tumours were freely movable in the vertical and lateral directions, but less so antero-posteriorly, the movement causing great pain. The abdomen had gradually increased in size. The bowel was opened by a longitudinal incision four inches long, and the smaller mass removed; the larger one required an enlargement of the abdominal and intestinal wounds. The colon was found considerably dilated, and its walls greatly hypertrophied. The mucous membrane was thickened, softened, purplish, and covered with numerous profusely bleeding polypoid excrescences. The wounds were closed with silk sutures. On the twenty-first day the patient left the hospital well. The extracted bodies proved to be very light enteroliths, resembling potatoes in their shapes, measuring six and four and a half centimetres in diameter; and on examination were found to consist of fine ligneous hairs or fibres of some tree with admixture of rye—and oat—barb scales. The belief was that the patient had been habitually eating bad bread made of flour mixed with some ligneous substance. Many years ago, she had probably had a localised inflammation of the colon accompanied by more or less profuse secretion of mucus. Some masses of inspissated mucus adhered to the intestinal wall, formed the nuclei around which the insoluble ligneous cells collected, and gradually formed the masses. (Khaloff, reported by J. Ewing Mears, 'Annual of the Universal Medical Sciences,' 1891, vol. iii. C—40.)

<sup>1</sup> *Trans. Path. Soc. Lond.* 1888, vol. xxix. p. 131.

**Fæcal accumulation.**—The abnormal accumulation of fæces within the large intestine as a whole, or in certain portions of it, occasionally gives rise to symptoms which call for surgical aid. But for such accidents the subject is one which falls more within the domain of the physician than the surgeon. Only such facts therefore will be introduced here as serve to elucidate and explain those complications to which such forms of obstruction may give rise.

Into the various causes which conduce to the accumulation of fæces in one or other part of the large bowel it is not proposed to enter, nor will any note be taken of the enormous masses which may so collect, and the variable periods occupied in their collection. For such details the reader is referred to an excellent résumé of the subject given by Treves in the 'Lancet' of 1885.<sup>1</sup>

No segment of the large intestine is exempt; one or more may be involved at the same time. The cæcum, however, is the commonest situation for fæcal collections, and next to it the sigmoid flexure; but in some instances the entire canal of the cæcum, colon, and sigmoid flexure become uniformly blocked and distended.

**Results of fæcal accumulation.**—In the majority of instances little more than a sense of abdominal discomfort exists, with possibly some loss of appetite and general malaise, the relief of which immediately follows upon a movement of the bowels. The following, however, are some of the untoward symptoms which may arise, and suggest the advisability of a surgeon's opinion, if not also his operative intervention.

*False tumour.*—A localised swelling, or pseudo-tumour formation, may in conjunction with other complications give rise to difficulty in diagnosis and mislead as to the true nature of the case. In a case reported by Worrall,<sup>2</sup> a girl aged 13 years was observed to have a rapidly growing tumour within the abdomen. An exploratory laparotomy was performed, when it was found that the cæcum and colon were enormously distended with fæces. The operation had a stimulating effect, as after it the bowel commenced to act and the girl recovered.

<sup>1</sup> Vol. ii. p. 1133.

<sup>2</sup> *New York Medical Record*, 1888, vol. xxxiii. p. 723.

Not infrequently these faecal tumours possess characteristics sufficiently distinctive to enable them to be diagnosed correctly. Thus they pit on pressure, have a dough-like feel to the touch, and can be modified in shape by squeezing. Pressure usually causes no pain. In other cases the tumour is quite hard and unresisting, conveying the sense of the presence of an intestinal calculus.

*Pressure.*—Symptoms of variable degrees of gravity arise as the result of pressure of a large accumulation upon some important organ. Middleton<sup>1</sup> describes two cases where the results of pressure were seen upon the heart. In one the apex beat was displaced upwards half an inch, and inwards, so as to lie nearer the sternum than usual. In the other the area of cardiac dulness and the apex beat were greatly displaced upwards. In this same case there was considerable pressure upon the bladder, great difficulty was experienced in micturition, no urine passing sometimes for twenty-four hours, and then only in very small quantity. In some cases of great distension the diaphragm is pushed upwards and impeded in its action, so that there is considerable embarrassment in respiration.

*Ulceration and perforation.*—A serious complication of prolonged faecal accumulation is ulceration of the bowel. This form of ulceration has already been discussed under the heading of ‘Stercoral ulcer’ (see page 437). It is only necessary to briefly refer to it here. The process of ulceration usually takes place slowly, and is frequently unattended by any indications until perforation occurs, when the patient is suddenly seized with violent and acute symptoms. Should the perforation cause a communication with the general peritoneal cavity, fatal peritonitis rapidly ensues. In a case recorded by Berry,<sup>2</sup> death took place from collapse following upon perforation of the sigmoid flexure. The patient had for years suffered from chronic constipation. At the post mortem the sigmoid flexure was of such dimensions as to reach the spleen and the liver, to which it was attached by old adhesions; its inner surface presented shallow ulcers and perforations. In another case, recorded by Southam,<sup>3</sup> death took place suddenly from perforation of a stercoral ulcer

<sup>1</sup> *Glasgow Med. Journ.* 1894, vol. xli. No. 5, p. 341.

<sup>2</sup> *Brit. Med. Journ.* 1894, vol. i. p. 301.

<sup>3</sup> *Ibid.* 1895, vol. i. p. 254.



situated on the posterior wall of the cæcum. The latter, with the colon, was found distended with hardened fæces. The patient, aged 67 years, had for some months suffered from incomplete intestinal obstruction.

In some instances the stercoral ulcer perforates into the neighbouring cellular tissue, or contracts adhesions to other parts, so that a localised fæcal abscess results, which may burst externally or empty itself into the bowel. Possible later sequels to these ulcers are strictures of the bowel.

*Rupture.*—In some few instances the enormous distension of the gut has led to rupture. The extraordinary power of adaptation which the bowel possesses under a slowly distending force renders it probable, however, that in most instances the rupture results from previous weakening of the intestinal wall through ulceration.

CASE XCIV.—*Chronic constipation, causing dilatation and rupture of the sigmoid flexure.*

A man aged 73 years had for several years suffered from chronic constipation. Three years before his death an attack of obstruction had yielded to a smart purge. Nine days before admission to hospital he was seized with symptoms of obstruction, and died from perforation. At the post mortem the sigmoid flexure was found enormously distended, resembling in shape and size an inverted and distended stomach. The inner surface showed several ulcers, and in several places the wall was gangrenous and perforated. The two ends of the sigmoid flexure were normal in size and position, and no other part of the intestinal tract was involved. (Berry, 'Trans. Clin. Soc. Lond.' 1894, vol. xlv. p. 84.)

Although this case is titled one of rupture, it is questionable whether it is not more strictly included under the head of 'Ulceration and perforation.' If, however, as assumed, ulceration is usually present, little distinction can be drawn between rupture and perforation.

*Convulsions.*—In a case reported by Squires,<sup>1</sup> a child, 11 months old, suffered from convulsions the result of great fæcal distension of the bowel. The mother stated that the child was 'terribly constipated.' The result of an enema was to bring away a great quantity of hardened scybala, the size of hickory nuts. The child was immediately relieved, and after one or two more enemata all the symptoms of obstruction disappeared.

<sup>1</sup> *New York Medical Record* 1888, vol. xxxi. p. 241.

*Fæcal absorption.*—The prolonged retention of fæces within the bowel is liable to result not only in some changes in the mucous lining of the intestine, but in some chemical alteration of the fæces themselves. The combined result of which it is possible to conceive might lead to the absorption into the system of products capable of causing variable symptoms suggestive of septic poisoning. An interesting case is recorded by Middleton,<sup>1</sup> where it would appear death resulted from the absorption of ptomaines or fæcal products. The patient's symptoms during life were persistent vomiting, high temperatures accompanied with delirium, and parotitis; enemata removed quantities of fæcal material. At the post mortem the large intestine was found to be full of hard fæcal masses. There was no obstruction.

*Acute obstruction.*—Ileus paralyticus, as this condition of acute obstruction is sometimes termed, is the worst and final phase of fæcal accumulation. Innocent as is the troublesome condition of chronic constipation in the large proportion of cases, instances are forthcoming to show that the limits of intestinal forbearance are sometimes reached, and for some usually inexplicable reason the patient more or less suddenly becomes attacked with symptoms of acute intestinal obstruction. In some instances, however, there have existed premonitory indications, in the way of greater difficulty than usual in getting a movement of the bowels, the trouble being accompanied with some loss of appetite, foulness of tongue and breath, nausea, and even vomiting, symptoms which for the time being have cleared up immediately the bowels have been opened.

Why, after a long period of constipation, symptoms of obstruction should suddenly arise it is not easy to determine. Treves<sup>2</sup> attributes the attack to one of these causes: abrupt occlusion of the colon by torsion or kinking, peritonitis set up by stercoral ulcers, and distension of the small intestine due to the long-tried ileum becoming finally exhausted and accumulation taking place above the ileo-cæcal valve. It may also possibly be due to paralysis of the large bowel, which finally refuses to react to any further stimulus, and so causes

<sup>1</sup> *Glasgow Med. Journ.* 1891, vol. xli. No. 5, p. 343.

<sup>2</sup> *Lancet*, 1885, vol. ii. p. 1133.

a stoppage as complete as that effected by a volvulus or an intussusception. The frequency with which, it is known, acute symptoms follow upon the administration of a purge to relieve a loaded colon, possibly receives its explanation from one of the last two causes given above. Fæcal accumulation is sometimes caused by pressure from without. Kidd<sup>1</sup> records five cases where it would appear that a displaced kidney had been the primary and immediate cause of inducing fæcal accumulation and obstruction.

When once acute obstruction has set in, the symptoms are practically indistinguishable from those arising from other causes of obstruction. The history of years of troublesome constipation, with the possible existence within the abdomen of a tumour, doughy to the touch, painless or only slightly painful, and capable of being moulded by pressure—such are the only features which can be said to lend aid of any value in the formation of a correct diagnosis. Even with these, however, it is sometimes impossible to say whether the symptoms may not be due to a tumour or to stricture; and the true nature of the case does not become manifest until at the time of the operation or post mortem.

**Treatment.**—Perforation or rupture the result of ulceration must be treated on the lines already laid down in connection with perforation of the bowel from other causes. What is of most interest, at present, is the treatment of cases which are suffering from, or show premonitory symptoms of, intestinal obstruction. It is mostly with such that the surgeon is, as a rule, concerned and where his opinion is required.

In most instances treatment of some kind has been adopted for the chronic condition of constipation which has preceded the acute attack, and has been persisted in and increased as preliminary treatment of the attack itself. Hence it is not infrequent to find that the patient has had powerful purgatives administered and copious enemata injected. The former only too often increase the severity of the symptoms, and no further trials of such a kind should be persisted in. The patient should rather be kept from the administration of anything by the mouth, food as well as medicine.

With regard to fluid enemata, either water or oil may be

<sup>1</sup> *Lancet*, 1894, vol. ii. p. 131.

employed ; the former is preferable. The object to be attained is percolation of the mass with fluid, so that, being thus loosened and softened, it may the easier be dislodged and passed. The additional distension may also serve as a stimulus to peristaltic action. The tube for injection should be inserted well up the rectum, if possible into the commencement of the sigmoid flexure ; it is doubtful whether it is possible to project it further than this. When the tube appears to pass higher up, it is more than likely that it is being doubled upon itself at the upper part of the rectum. The fluid may be passed in, either by means of an ordinary Higginson's syringe, or allowed to gravitate from a funnel or filler held two or three feet above the bed.

Massage may prove of considerable service, but should only be employed at an early stage of the symptoms. If a mass can be felt it should be carefully kneaded ; and to facilitate the action of the hand and fingers, some lubricant, such as oil or vaseline, should be freely applied.

Failing any relief by such conservative measures, it becomes necessary to consider the question of emptying the bowel by operation. The operation best suited for removing the contents of the bowel is colotomy. It has been several times practised with success. Pye-Smith<sup>1</sup> refers to a case, and Cripps<sup>2</sup> records an example, where, after removal of an impacted mass from the descending colon, he successfully opened the cæcum to relieve the distension which failed to subside after opening the colon. A third example is given in the case narrated below. A right lumbar colostomy performed in this case was followed by rapid relief of the symptoms.

Assuming that there is no guide to the portion of the bowel most involved, an incision in the left iliac region should be first made ; if, however, the sigmoid flexure be found undistended, the wound should be closed, and the cæcum explored by an incision in the right iliac region.

CASE XCV.—*Acute intestinal obstruction caused by faecal accumulation : colostomy. Recovery.*

A man aged 64 years had up to seven months before admission to hospital been in good health, with, as a rule, regular action of the bowels.

<sup>1</sup> *Brit. Med. Journ.* 1894, vol. i. p. 301.

<sup>2</sup> *Ibid.* 1893, vol. i. p. 398.

At this period, however, he commenced to be troubled with constipation; and a few months later he suffered for several days from 'stoppage' of the bowels. The attack was attended with great abdominal pain and vomiting, but the symptoms yielded to large injections of oil and warm water. Another similar attack occurred three months later, and while in this attack he was removed to hospital.

On admission he appeared in a critical condition, suffering much distress. The bowels had not acted for ten days, and the abdomen was very tense and tympanitic. A well-marked localised fulness and resistance existed over the umbilical region. This swelling was elastic and not doughy in character. His mouth was dry, and he vomited large quantities of a dirty brown fluid.

Right lumbar colostomy was performed. Large quantities of soft faecal matter escaped, and relief to the symptoms immediately resulted. A few days after the operation faeces began to pass through the rectum, and increased till the external wound closed all but a small fistula, through which gas occasionally escaped. About a month after he left the hospital he was again seen, and was then in very good health. (T. Ward Cousins, 'Lancet,' 1890, vol. i. p. 80.)

---

## CHAPTER LVI

### TUMOURS—INNOCENT AND MALIGNANT

WITH the exception of carcinoma, tumours involving the large intestine resemble those met with in the small. They may differ, however, in their relative frequency, the large bowel being more often the seat of certain kinds than the small; and they may differ also in their clinical aspects, more acute and serious symptoms being liable to arise when the tumour is situated in the small than in the large intestine.

Adopting the usual division of innocent and malignant growths, the latter are more frequently met with in clinical practice than the former, though in the post-mortem room innocent tumours are often discovered which have caused no symptoms during life.

**Innocent tumours.**—In many instances, as already indicated, these tumours are purely of pathological interest, being frequently found in the ordinary course of making a post mortem. Many are, however, capable during life of causing symptoms of obstruction, either by reason of their blocking

the canal, or in some other way acting upon the bowel wall so as to invaginate, kink, or twist it.

*Papilloma and adenoma.*—These benign tumours are among the commonest met with in the large intestine. They vary greatly in size, shape, situation, and the symptoms to which they give rise. They are generally simple outgrowths from the mucous membrane, and resemble it in structure, being either purely papillary excrescences or glandular in formation. In some instances they are multiple, involving in such cases not only different parts of the colon, but extending into the rectum; or rather, it should be said, from the greater frequency with which they are met with in the rectum, they have extended from there into the colon. A good illustration of such multiple papillomata is recorded by Dalton.<sup>1</sup> The symptoms were mostly associated with the papillomatous mass in the rectum, the patient suffering from pain in that part, coupled with the passage of blood and mucus. At the post mortem isolated growths were found in the sigmoid flexure and colon, and a considerable group in the upper part of the cæcum. The patient was a man aged 28 years.

If instead of remaining sessile these tumours increase in size, they become pedunculated and constitute one of the commonest forms of intestinal polypus. As such they become a not infrequent cause of intussusception. In this relation they have already been discussed, the colic form being frequently due to their presence. When so associated the tumour forms the apex of the presenting intussusceptum.

It occasionally happens that a polypus becomes spontaneously detached and is passed *per rectum*; but, failing such a natural method of cure, these tumours may remain throughout life, apparently harmless and without causing symptoms. A case recorded by Handford,<sup>2</sup> however, would seem to show that it is possible for these innocent growths to become cancerous in character. In the instance referred to, the bowel from the middle of the transverse colon to a malignant stricture in the rectum was studded with polypi, about 170 in all, most numerous in the sigmoid flexure and in the rectum. Some were sessile and some pedunculated. At one place the

<sup>1</sup> *Trans. Path. Soc. Lond.* 1893, vol. xlv. p. 85.

<sup>2</sup> *Ibid.* 1890, vol. xli. p. 133.

stages of transition from a simple to a malignant type could be well observed.

*Fibroma and fibro-myoma.*—As in the case of the small intestine, these tumours occurring in the large bowel constitute one of the forms of polypus. They vary in size, but are usually small. Kidd<sup>1</sup> showed a specimen at the Pathological Society of London of a fibroma about the size of a pea, which was attached to the inner wall of the cæcum.

*Lipoma.*—Fatty tumours are occasionally met with, either growing within the bowel or connected with it externally. In the latter case they are usually associated with the appendices epiploicæ. Foulerton<sup>2</sup> pictures an instance of three fatty tumours in this situation hanging from the transverse colon. They occurred in a patient who died of carcinoma.

Fatty tumours arising within the bowel have their origin in the submucous tissue. They may grow to a considerable size, and sometimes form pedunculated tumours or polypi. Hofmokl<sup>3</sup> reports a case in which a submucous lipoma filled the entire lumen of the intestine for several inches. It led to the ascending colon being invaginated into the transverse. In another case, reported by Link,<sup>4</sup> the tumour was situated in the descending colon; it was about the size of a man's fist, pedunculated, and capable of being felt externally. It was successfully removed. A fatty tumour combined with vascular tissue, under the title of lipomatous angioma, is described by Williams<sup>5</sup> as having been found in the descending colon.

*Dermoids.*—These tumours are occasionally met with in the large intestine. They form usually pedunculated growths, and when situated in the sigmoid flexure project into the rectum, where they can be felt. In a case recorded by Clutton,<sup>6</sup> the tumour, which could be previously detected in the rectum, was removed; and when examined, it measured about three inches in its longest diameter, and weighed an ounce and a quarter. It was covered externally with a skin, on the surface of which were numerous hairs, while inside it contained a

<sup>1</sup> *Trans. Path. Soc. Lond.* 1885, vol. xxxvi. p. 210.

<sup>2</sup> *Illustrated Medical News*, 1889, vol. v. p. 124.

<sup>3</sup> *Annual of the Universal Medical Sciences*, 1893, vol. iii. C—41.

<sup>4</sup> *Ibid.* 1891, vol. i. D—19.

<sup>5</sup> *Ibid.* 1895, vol. i. D—58.

<sup>6</sup> *Trans. Path. Soc. Lond.* 1886, vol. xxxvii. p. 252.

small portion of bone, fat, and fibrous tissue. Another case is reported by Floyer.<sup>1</sup> The tumour occurred in a girl aged 8 years, who, when at stool, suffered from tenesmus. It projected from the anus, was ligatured at its base and removed.

*Cysts.*—These are little more than pathological curiosities. Sainsbury<sup>2</sup> exhibited at the Pathological Society of London a tumour about the size of a duck's egg, ovoid, smooth, and elastic. When cut into, it proved to be a cyst filled with very dark ropy (mucoid) fluid. It was considered as possibly a cystic dilatation of one of the lips of the ileo-cæcal valve.

**Malignant tumours.**—Of the two primary forms of malignant growths, carcinoma is frequently met with, while sarcoma but rarely occurs. The bowel, when attacked by either form of disease, may be involved primarily, or growths may occur in it secondarily to primary disease elsewhere, or it may become implicated by direct extension from some neighbouring seat. When malignant disease of the large intestine is spoken of, it is always, however, taken to imply primary involvement of that region, and as such it will alone be discussed here.

*Carcinoma.*—The disease attacks both sexes in about equal proportion, with slight tendency, perhaps, to be commoner among females than males. There is no part of the large intestine exempt, but in by far the larger number of cases it is either the cæcum or the sigmoid flexure and the descending colon. Out of fifty cases which I have collected, thirteen occurred in the cæcum, thirteen in the sigmoid flexure, and eight in the descending colon: and in making an abstract of Franks's tables of colectomy,<sup>3</sup> out of thirty-seven cases, ten occurred in the cæcum, ten in the sigmoid flexure, and nine in the descending colon. The relative frequency with which other segments of the large bowel are involved is best seen by reference to the accompanying tables.

The disease is most frequently met with after middle life, but is not uncommon between the ages of 30 and 40, and has occurred in a case reported by Powell<sup>4</sup> at the early age of 23

<sup>1</sup> *St. Thomas's Hospital Reports*, 1885, vol. xv. p. 239.

<sup>2</sup> *Trans. Path. Soc. Lond.* 1887, vol. xxxviii. p. 146.

<sup>3</sup> *Trans. Royal Med.-Chir. Soc.* 1889, vol. lxxii. p. 211.

<sup>4</sup> *Westminster Hospital Reports*, 1890, vol. vi. p. 94.



*Author's Table of Fifty Cases of Carcinoma of the Large Intestine, showing situation of the disease*

Ileo-cæcal valve	Cæcum	Ascending colon	Hepatic flexure	Transverse colon	Splenic flexure	Descending colon	Sigmoid flexure
6	13	4	1	3	2	8	13

*Abstract of Franks's Table of Cases of Colectomy, showing same as above*

Ileo-cæcal valve	Cæcum	Ascending colon	Hepatic flexure	Transverse colon	Splenic flexure	Descending colon	Sigmoid flexure
—	10	1	2	3	2	9	10

years, and at 22 in a case recorded by Sendler, who was successful in resecting the growth.

**Pathology.**—Before attempting any description of the form or forms of carcinoma which attack the large intestine, it will possibly simplify the discussion if it be first stated what classification constitutes the basis for reference. So many terms are used and in such different senses that in many instances it is impossible without some such basis to determine what particular form is meant.

Thus, then, I have adopted the three primary divisions of squamous-celled, columnar-celled, and spheroidal-celled carcinoma. The first two constitute the epitheliomata, while the last embraces the medullary and scirrhous forms of carcinoma, both of which signify histologically the same structure, and only differing in the relative proportion of cells and intercellular fibrous tissue. The former is rich in cells and scanty in intercellular fibrous trabeculæ, while the latter is scanty in cells and possesses abundant fibrous tissue. All three divisions are capable of undergoing a colloid change, when the tumour constitutes the so-called colloid carcinoma.

If this classification can be admitted as embracing all forms of carcinoma, then all difficulty in naming any particular growth becomes materially simplified. It requires, however, that the growth be microscopically examined in order to determine, in the majority of instances, to which class it belongs. Unfortunately, in a large number of the cases recorded, terms are so loosely employed that it is impossible to

understand whether the name is intended to have only a vague clinical significance or whether it is strictly histological.

Judging from such cases as have been accurately investigated, it would appear that almost without exception the form of carcinoma met with in the large bowel is the columnar-celled; and where colloid disease has been met with, it is degenerative change taking place in these same cells. That this form of tumour may assume considerable variations in its mode and rapidity of development is only reasonable to suppose from what occurs in the case of tumours elsewhere. This variation has doubtless led to the use of terms descriptive solely of macroscopical appearances. Thus the commonest form which is met with when the growth has developed to a visible and tangible extent, is a dense hard ring surrounding the gut at one particular point (see Plate XX, fig. 58). It is not difficult to understand how this indurated consistence may lead to it being termed a scirrhus tumour, nor is it any more difficult to see how any excessive growth causing a vascular or sloughing projecting mass into the canal should be termed a medullary, soft, or villous carcinoma.

Unless, therefore, it can be shown by a competent microscopist that any other form of carcinoma than the columnar-celled attacks the intestine, it would be wiser to accept all those cases that are described as medullary, encephaloid, scirrhus, adenoid, villous, or colloid, as variations in development of the one division of columnar-celled carcinoma.

Columnar-celled carcinoma presents usually, in the more or less advanced stage of its development, two separate appearances. In its commonest aspect it constitutes the so-called ring stricture of the bowel. Externally it looks as if the intestine had been constricted by a string tied round it. Internally the canal is contracted at the same situation by a band of tissue which may narrow it to any degree. Frequently there is ulceration at the seat of stricture, and the upper margin of the ulcer presents a typically everted and indurated margin (see Plate XXI, fig. 59). In some cases the stricture is of a much more irregular character, the region of the disease being extensively ulcerated and the bowel wall considerably puckered.

In its other aspect the tumour, in its growth from the

PLATE XX.



Fig. 58.—CYLINDER-CELLED CARCINOMA OF TRANSVERSE COLON.—The growth caused stricture of the bowel. The small aperture of continuity which existed is indicated by a piece of whalebone. (*W.I.M., Glas.*)



bowel wall, projects as a definite mass into the canal, tending as it increases in size to block entirely the passage. In a case recorded by Dalton,<sup>1</sup> the carcinoma formed a polypoid excrescence hanging from the wall of the descending colon. Should ulceration attack the growth an irregular sloughing mass may result, with the occasional detachment of portions which are carried away, and so temporarily relieve the obstruction.

The effect of the growth within the bowel or its walls is to lead to other pathological lesions dependent upon the obstruction it causes, and the progressive destruction of tissue. The result of the obstruction is to cause dilatation and hypertrophy of the bowel immediately above the seat of the disease; and, in consequence of the prolonged retention of the fæces in the dilated part, the mucous membrane becomes inflamed and ulcerated, and may at last get so weakened that perforation or rupture takes place. Such perforation may prove the incentive to a fatal peritonitis, or result in the formation of a fæcal abscess.

As the result of progressive destruction of tissue, adhesions are contracted between the involved part and the neighbouring tissues. This may be followed by a direct invasion by the tumour, and should destruction of tissue still proceed, communication may be established between the large bowel and some other viscus. In a case reported by Johnson,<sup>2</sup> adhesion took place between the seat of disease and the ileum, with the result that a fistulous communication was established between these two portions of the intestine. In another case, reported by Jonchères,<sup>3</sup> a communication was opened up between the stomach and the colon. And in one operated upon by Heuston,<sup>4</sup> the bladder was opened into.

Suppuration in connection with malignant disease of the bowel is not uncommon, and probably owes its origin in most instances to the exposure of a raw ulcerating surface to septic infection by the fæcal contents. The effects of such infection may show themselves locally at the seat of the disease, or more remotely. In the former case abscess forms in direct

<sup>1</sup> *Trans. Path. Soc. Lond.* 1890, vol. xli. p. 122.

<sup>2</sup> *Ibid.* 1889, vol. xl. p. 110.

<sup>3</sup> *Annual of the Universal Medical Sciences*, 1895, vol. i. D—57.

<sup>4</sup> *Brit. Med. Journ.* 1894, vol. i. p. 405.

connection with the ulcer, and, from its acute character, progresses until it is discharged. In a case reported by Money,<sup>1</sup> a large post-cæcal abscess formed in connection with carcinoma of the ileo-cæcal valve. In the case of abscess formation at some more distant situation, the liver is the part most likely to suffer. Such cases become pyæmic in character, and this proves the immediate cause of death. Examples of such a result are afforded by cases published by Dyson<sup>2</sup> and by Finlayson.<sup>3</sup> In the case of the former the patient was seized with rigors, and had high temperatures. Œdema of the right leg appeared first, and then both were involved. At the post mortem a quantity of purulent matter and débris was found in the centre of the growth. In Finlayson's case high temperatures also existed, and at the post mortem numerous small abscesses were found located in the liver.

As the stricture tightens, or the obstruction increases, the more solid and undigested constituents of the bowel contents become retained, and hence it is frequently found that the dilated portion of the intestine above the obstruction is loaded with foreign bodies and scybalous masses, cherry and other fruit stones being among the commonest examples of the former. It is usually some such solid mass which, suddenly becoming impacted or blocked in the narrowed channel, gives rise to an attack of acute obstruction.

Except in the case of secondary growths it is unusual for carcinoma to attack more than one part of the bowel. The following two cases, however, seem to show that multiple involvement is possible. Symonds<sup>4</sup> reports a case where, in addition to a malignant stricture in the sigmoid, a second stricture was found in the ascending colon which had been the means of causing the death of the patient. In the other case, reported by Weichselbaum,<sup>5</sup> in addition to numerous polypi in the large and small intestine, three deposits of cancer were found, one in the cæcum, a second in the transverse colon, and a third in the rectum.

<sup>1</sup> *Trans. Path. Soc. Lond.* 1889, vol. xl. p. 103.

<sup>2</sup> *Lancet*, 1884, vol. ii. p. 1005.

<sup>3</sup> *Trans. Path. and Clin. Soc. Glasgow*, 1893, vol. iii. p. 145.

<sup>4</sup> *Brit. Med. Journ.* 1893, vol. i. p. 638.

<sup>5</sup> *Annual of the Universal Medical Sciences*, 1895, vol. i. D—57.

PLATE XXI.

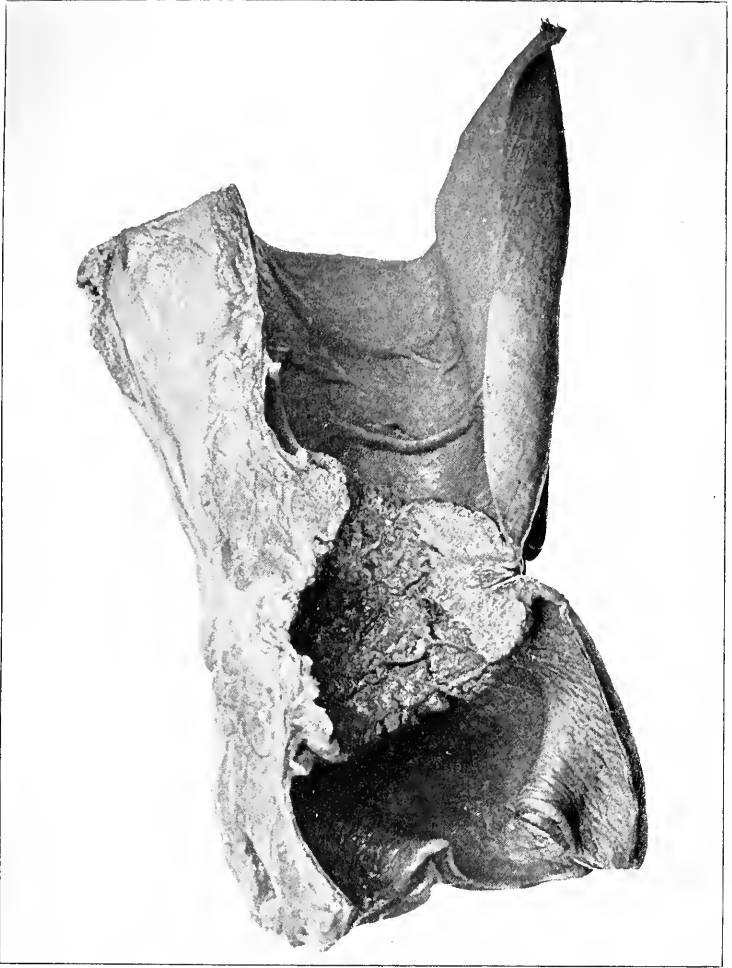

Fig. 59.—CARCINOMA OF COLON producing ulceration and stricture. (*W.I.M., Glas.*)





Secondary growths arising from primary disease in the bowel are most frequently met with in the mesenteric glands. The liver also is often invaded. In a case recorded by Moore,<sup>1</sup> the rapid growth of a tumour in the liver was a prominent clinical feature.

**Symptoms.**—In most cases there have been symptoms dating back for periods varying between a few weeks and several months. The patient has been troubled with what has been considered indigestion or biliousness and treated accordingly. There may have been diarrhoea, which has sometimes alternated with constipation, or the latter has been an increasingly troublesome complaint throughout. The diarrhoea which occurs is usually of a spurious kind, and is due mostly to the escape of the more fluid constituent of the fæces past the main mass of solid material lodged above the seat of obstruction. The local enteritis set up by the irritative action of this hard fæcal mass also tends to produce excretion of mucus, and excite peristaltic action of the bowel beyond. The intercurrent attacks of constipation, or possibly its unbroken continuance, is produced by the temporary blocking of the constricted or contracted canal by solid fæces which only pass with difficulty.

The solid fæces, when discharged *per anum*, present nothing out of the ordinary except when the disease is situated low down in the sigmoid flexure, when they occasionally appear flattened or ribbon-shaped. The presence of blood in the fæces, or discharged independently, is occasionally met with. It varies considerably in quantity, being more frequently small than large, and is observed more often when the disease is located in the sigmoid flexure than elsewhere. The patient sometimes complains of tenesmus, felt more particularly when at stool.

Pain is a symptom which increases with the increase in narrowness of the canal. It is intermittent and colicky in character, depending more upon the amount of obstruction than upon the extent of the disease. Attacks of vomiting occasionally occur, and what with loss of appetite, and often some nervous depression, emaciation soon becomes a marked feature.

<sup>1</sup> *Trans. Path. Soc. Lond.* 1891 vol. xlii. p. 172

Physical examination of the abdomen may or may not detect the existence of a tumour. When the disease is in the form of a stricture, it is more than likely to be masked by the distension of the bowel above. In cases where there has been prolonged chronic obstruction, the abdomen gradually becomes distended and tympanitic. In a case recorded by Courteen,<sup>1</sup> this distension assumed such unusual proportions that it caused severe dyspnœa, and the pressure upon the vena cava produced œdema of the legs and scrotum. Palpation of the abdomen sometimes induces a visible peristalsis accompanied by colicky pains. Independently, however, of manipulation, peristalsis is often seen, especially at those times when the patient is seized with an attack of griping pain. Other sensations are often complained of. The patient is conscious of an action in the bowels which seems to work up to a certain point, and end in a sort of gurgle, indicating possibly the escape of gas through the narrowed canal.

A sudden complete block of the canal calls forth a new and acuter train of symptoms. The patient now complains of almost constant pain in the abdomen. Distension becomes more marked and peristalsis more visible. Vomiting becomes constant, and may continue until it is fœcal. The pulse is usually small and rapid, and becomes more markedly so as time progresses. The temperature may be normal. The patient's complexion is pale or sallow, with the typical abdominal expression of sunken features, and dark depressions below the eyes. The rectum when examined is found empty, and when fluid is injected, it returns practically unstained by fœces.

When in the course of a case of chronic obstruction fever symptoms arise, these must be taken to indicate either the commencing formation of an abscess, or the absorption into the system of some septic material, with possibly pyæmic abscess-formation elsewhere. In the post mortem which I made upon Finlayson's case, already referred to, the rise in temperature was explained by the numerous minute pyæmic abscesses which were found in the liver.

Another intercurrent complication of malignant disease of the bowel is perforation. This may occur at any period of

<sup>1</sup> *Westminster Hospital Reports*, 1886, vol. ii. p. 204.

PLATE XXII.



Fig. 60.—COLLOID CARCINOMA OF SIGMOID FLEXURE.—The specimen was taken from a child aged 12 years which had died of acute intestinal obstruction. The growth had caused stricture of the bowel. (*W.I.M., Glas.*)



the disease, and will be known, as a rule, by the great suddenness with which acute symptoms set in. The acute abdominal pain, coupled with great collapse or prostration, will suggest the nature of the accident.

---

## CHAPTER LVII

CARCINOMA (*continued*). DIAGNOSIS. PROGNOSIS. TREATMENT

**Diagnosis.**—In most cases the diagnosis of malignant disease of the large bowel must be purely conjectural, and based rather upon probabilities than upon actual ascertained facts. Gradually increasing difficulty in defecation occurring in a patient past middle life, accompanied with emaciation, will, from the simple consideration of probabilities, indicate, in the large majority of cases, carcinoma of some portion of the large intestine.

The particular seat of the disease can only occasionally be determined. When situated at the ileo-cæcal valve, it is usual for the symptoms to resemble those of disease of the small intestine. There are, however, exceptions, as illustrated by a case reported by Johnson,<sup>1</sup> where they were suggestive of chronic obstruction of the large intestine. When the disease is situated in the sigmoid flexure, vomiting, as a rule, is less marked than when the disease is located higher up, and more rarely becomes fæcal. Blood in the motions is more frequent with disease in this part, and the shape of the solid motion is sometimes altered, being flattened. The most valuable aid to the situation of the obstruction may sometimes be derived from the injection of water *per rectum*. The larger the quantity which can be injected, and the longer the time it can be retained, the more likely is the seat of obstruction to be high up. Both auscultation and palpation should be employed in endeavouring to determine the passage of the fluid along the colon. It needs to be remembered that it is possible for the fluid to find its way past the obstruction, and in so doing to obscure the diagnosis.

**Prognosis.**—It is usual for death to occur in uncomplicated

<sup>1</sup> *Trans. Path. Soc. Lond.* 1889, vol. xl. p. 110.

cases in less than a year from the onset of the earliest symptoms. In many instances the period would seem to be much shorter, but the difficulty of assigning the date of the commencement of the disease renders it impossible to fix more than a comparatively vague average. So slight may be the suffering in the early stages, that the patient has offered no complaint until suddenly seized with symptoms of acute obstruction. Temporary relief occasionally occurs and deludes the patient into the belief that the disease has disappeared. The true state of the case, however, is, that the channel has been opened up by the sloughing away of an obstructing mass of tumour. In other cases, again, relief arises from the formation of a fæcal abscess, which, bursting externally, allows of the passage of fæces from time to time through the fistula. Communications may also be established with some other part, as the bladder or another portion of the intestinal tract.

The relative advantages to be gained by operation, and the chances this holds out for the cure of the disease or the prolongation of life, will be best discussed under the subject of treatment.

CASE XCVI.—*Carcinoma of the ascending colon causing chronic obstruction: colectomy. Recovery.*

A woman aged 36 years began to be attacked with pain in the abdomen and flatulence towards the latter part of 1893. The pain was of a colicky nature, and often very severe, and the abdomen was always more distended than it used to be. In December, vomiting at intervals commenced and her appetite failed. With the help of medicine the bowels were fairly regularly moved, but she gradually lost flesh, and becoming unfit to attend to her household duties, finally took to bed. When first seen in consultation, she was in a weak state of health, with colicky pains, abdominal distension, and vomiting. The bowels were only moved with great difficulty, and the motions contained mucus and sometimes blood. The seat of the disease could not be located, but was thought to be high up, as large enemata could be retained.

*Operation.*—A median exploratory incision was made, and a tumour discovered, in the ascending colon. This incision was closed, and a second made over the position of the growth. Immediately the abdomen was opened, the cæcum, greatly distended, bulged into the wound and interfered with the progress of the operation, so it was incised and a quantity of gas and fluid fæces allowed to escape. When the bowel had emptied itself, the opening was clamped, and the mesenteric vessels leading to the affected portion of bowel were ligatured, the mesentery divided, and the

loose loop of gut brought out of the abdominal cavity. About five inches of bowel were now excised, and glass intestinal drainage tubes were tied into each end. Finally the wound in the mesentery was drawn together with green catgut, and the two ends of the bowel were attached side by side. On the seventh day the upper tube was removed, and the lower on the tenth. On the fourteenth day a pair of long dressing forceps were tied in with the object of removing the spur. This being accomplished to a sufficient depth, the rosette of mucous membrane showing on the surface was separated from the skin and sutured together, and the skin closed over it. Primary union occurred, and henceforth the bowels were moved by the natural passage. (F. T. Paul, 'Brit. Med. Journ.' 1895, vol. i. p. 1138.)

*CASE XCVII.—Carcinoma at the junction of the cæcum and ascending colon causing acute obstruction : colostomy : intestinal anastomosis. Death three months after from exhaustion.*

W. S., aged 27 years, was admitted into the Bristol General Hospital on October 15, 1894, with the following history. For five months he had been subject, every few weeks, to attacks of pain in the right iliac fossa, lasting a few hours, and accompanied by the presence of a round, firm swelling the size of a hen's egg, which appeared midway between the anterior superior spine and the umbilicus, and always disappeared as the pain ceased. A fortnight before admission general abdominal pain set in. The bowels acted for the first week, but there had been complete obstruction (no flatus having been passed) during the last. On admission he was very much emaciated. The abdomen was considerably and uniformly distended, and every few minutes distended coils became visible, and a very hard swelling formed in the right iliac fossa which felt like a solid mass, but it subsided with the cessation of the peristalsis. No satisfactory action of the bowels could be obtained by enemata.

*Operation.*—An exploratory median incision was made and a distended cæcum and a collapsed sigmoid flexure discovered. This incision was then closed, and a second made over the cæcum, when a constricting mass of new growth was found at the junction of the cæcum and ascending colon, binding the bowel down inseparably to the iliac fossa. The cæcum was stitched to the abdominal wall and opened. About three months later a second operation was performed, which consisted in forming an anastomosis between the small intestine and the sigmoid flexure. This was successfully effected by means of Murphy's button. The patient lived for three months, and then died from gradual exhaustion due to the increased growth of the tumour. (Charles A. Morton, 'Brit. Med. Journ.' 1895, vol. i. p. 859, and vol. ii. p. 962.)

**Treatment.**—If the same reasoning is to be applied to carcinoma of the bowel as is considered proper in the case of carcinoma elsewhere, then so soon as the disease is diagnosed or even only suspected it should be dealt with, without further delay, by surgical measures. There is everything to hope for

in early treatment, while with delay the situation becomes aggravated. To attempt to remove the disease at an early period is to do so when it is most limited, and when the patient is best fitted to endure the operation. But any such endeavour at a late stage may not only be inadvisable, but possibly prohibited, and nothing but palliative measures can then be employed.

Statistics cannot be said to prove much at any time, and possibly in connection with the treatment of carcinoma of the large intestine they are, for many reasons, specially of little value. The publication of individual successful cases is encouraging, but cannot be said to establish a particular course of general application. Taken, however, for whatever they may be worth, the following statistics are not without interest.

In 1889 Franks<sup>1</sup> published a table of fifty-one cases of colectomy performed between the years 1843 and 1888. Of these, twenty died as the result of the operation within thirteen days, giving a mortality of 40·8 per cent. In only one case does there appear to have been what was considered a cure; in this instance four inches of colon were removed, and no recurrence was observed at the end of four years.

In 1895 Mayo Robson<sup>2</sup> reported thirteen cases of colectomy operated on in the Leeds Infirmary during the past two years. The record shows a mortality of 23 per cent.

Such evidence as the above seems to show, therefore, that the various modern improvements in intestinal operations have materially lessened the rate of mortality following thereupon; and as each year adds an increasing number of successful cases, it may be reasonably hoped that the operation of colectomy will soon occupy an established position among the methods of treating this disease.

If the disease can be located by external examination, a sufficient guide exists for the line of incision, which should be carried through the parietes over the affected area; if no such evidence can be obtained, an exploratory incision should be made in the median line, and the situation and extent of

<sup>1</sup> *Trans. Royal Med.-Chir. Soc. Lond.* 1889, vol. lxxii. p. 211.

<sup>2</sup> *Brit. Med. Journ.* 1895, vol. ii. p. 965.



the disease ascertained. The median incision is then closed, and a second made over the affected area.

Assuming that excision is the proper course to adopt where the tumour or stricture is free and non-adherent and the patient's condition good, the question then to decide is the kind of operation to perform. Should excision be immediately followed by end-to-end or lateral anastomosis and the bowel returned into the abdomen; or should both ends of the divided intestine not be united, but secured outside the abdomen, and the continuity of the canal established at a later period? Or, thirdly, should the tumour with the involved bowel be withdrawn from the abdomen, an artificial anus made, and the growth subsequently removed?

Each of these three methods can claim success, but the last two are apparently the safer. As an example of the first method, a case recorded by Lilienthal<sup>1</sup> may be given. Four inches of the transverse colon were removed for carcinomatous stricture of the part; end-to-end anastomosis was effected by a large Murphy's button. A wedge of meso-colon and that part of the omentum which adhered to the new growth were also removed, and with it the entire distal omentum. The patient made a good recovery, gaining both in weight and strength. The button was passed on the eighteenth day without pain. The second method is advocated by Paul,<sup>2</sup> who, in a very fair and impartial discussion of the question based on practical experience, advises that immediate end-to-end anastomosis by Murphy's button should only be attempted 'when the patient is in good condition, the abdomen not distended, the tumour small, and the proximal end of the bowel not greatly hypertrophied;' and, I should venture to add, the ends of the divided bowel capable of being approximated without tension. Such, however, is usually likely to be the case when the tumour is small. Under the opposite conditions Paul advocates the bringing of the ends of the bowel out of the wound and securing them there with glass drainage tubes inserted into both. For details of the method of operating see *Operations upon the Intestines*.

There is but little difference between the second and third

<sup>1</sup> *New York Med. Journ.* 1894, vol. lx. p. 264.

<sup>2</sup> *Brit. Med. Journ.* 1895, vol. i. p. 1136.

methods of operating. The delay, however, in removing the growth lessens somewhat the magnitude and immediate danger of the operation. Allingham,<sup>1</sup> in a case of successful excision by this latter method, pulled the growth with about fifteen inches of the gut through the inguinal incision and secured it outside the abdomen. An artificial anus was made, and ten days later the tumour was removed.

When the disease is more extensive and more of the bowel is involved than will admit of the case being considered suitable for excision by any one of the three methods above described, other measures have to be carried out.

Reverdin<sup>2</sup> reports a successful case of removal of the transverse colon for a cylindrical epithelioma which involved the intestine for nine inches. The distal end of the colon was invaginated and sutured, while the proximal end formed an artificial anus just above the umbilicus. The patient four months afterward had gained considerably in weight.

When excision is impossible, or from secondary growths elsewhere inadvisable, either a colostomy should be performed, which of all palliative measures may be considered the safest, or the ileum should be implanted into the colon below the seat of disease; in other words, an ileo-colostomy performed. In cases where the disease involves the cæcum so that it is impossible to open the large bowel on the proximal side, ileostomy must be performed. Briddon<sup>3</sup> reports having successfully accomplished this in a case where the disease was so extensive as to implicate the whole length of the large intestine.

Should operation be refused by the patient, or for any other reason be deemed inadvisable, an endeavour must be made to relieve the bowels either by the administration of suitable aperients or the use of fluid enemata.

*Sarcoma.*—The rarity of this kind of tumour affecting the large bowel as a primary disease, renders it unnecessary to more than briefly allude to it. It is said to attack the bowel usually in the form of the spindle-celled variety. I have only come across the record of two cases within recent years.

<sup>1</sup> *Trans. Clin. Soc. Lond.* 1893, vol. xxvi. p. 140.

<sup>2</sup> *American Journal of the Medical Sciences*, 1893, N.S. vol. cv. p. 588.

<sup>3</sup> *Annals of Surgery*, 1894, vol. xx. p. 414.

PLATE XXIII.



Fig. 61.—ROUND-CELLED SARCOMA OF LARGE INTESTINE.—The tumour caused no symptoms during life. Similar masses and nodules were found in the cerebellum and in the right lung. (*W.I.M., Glas.*)



Hofmohl<sup>1</sup> reports having successfully excised the cæcum, part of the ascending colon, and the appendix for an adenocarcinoma; and Abbe<sup>2</sup> removed a large mass affecting the same regions of the bowel from a boy aged 6 years, who died thirty-six hours after the operation from shock. No microscopic description of the tumour is given, so that some doubt must attach to the true character of the growth.

Lymphadenoma, although more frequent in its involvement of the stomach and small intestine, sometimes attacks the large bowel, as instanced by cases collected and recorded by Pitt.<sup>3</sup>

---

## CHAPTER LVIII

### IDIOPATHIC DILATATION. ABNORMALITIES: MISPLACEMENTS AND MALDEVELOPMENT

**Idiopathic dilatation of the colon.**—Intimately associated with faecal accumulation, if not often dependent upon it, is so-called idiopathic dilatation of the colon. Numerous cases are on record, both of young and old, where from no known cause segments of the large intestine have become enormously distended and led to symptoms which have simulated those of obstruction and suggested operative intervention for their relief.

As already indicated, it is possible that in some of these cases of great distension the colon has suffered as the result of chronic constipation. In others, again, it is possible that some slight kinking or twisting has caused temporary or partial obstruction, with consequent gradual distension. There are cases, however, in which the enlargement appears to be unquestionably congenital, and it is more particularly with these that the term 'idiopathic dilatation' has come to be associated. In the remarkable instance recorded by Walker,<sup>4</sup> the enlargement of the abdomen was noticed a

<sup>1</sup> *Annual of the Universal Medical Sciences*, 1889, vol. iii. B—31.

<sup>2</sup> *Annals of Surgery*, 1895, vol. xxi p. 592.

<sup>3</sup> *Trans. Path. Soc. Lond.* 1889, vol. xl. p. 80.

<sup>4</sup> *Brit. Med. Journ.* 1893, vol. ii. p. 230.

few weeks after birth, and it continued to increase until the child died of emaciation and exhaustion at the age of

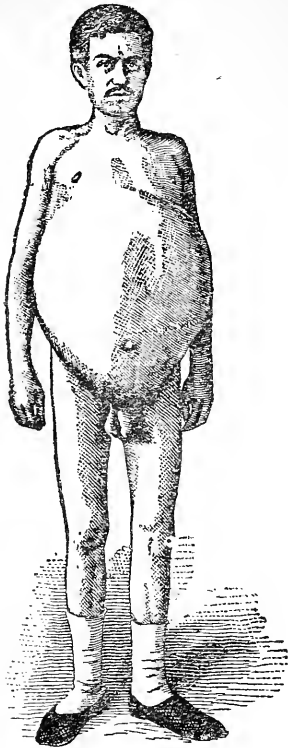

FIG. 62.—ENORMOUS CONGENITAL DEVELOPMENT OF COLON. (Formad)  
Front view, showing distension of abdomen.

11 years. At the post mortem the transverse and descending colon measured twenty-three inches round, 'looking like a large leg and thigh.' The commencement of the cæcum and the distal end of the sigmoid flexure were normal. A still more remarkable case appears to be that reported and figured by Formad<sup>1</sup> (see fig. 62). The patient, aged 29 years, had so large an abdomen that he was exhibited under the name of the 'balloon man.' He died suddenly from syncope, the result, it was supposed, of pressure on, or displacement of, the heart. The colon was as large as that of an ox. His chief symptom during life was constipation. In another case, reported by Hirschsprung,<sup>2</sup> death occurred early—the child only reached the age of 2 months. At the post mortem the transverse colon was found enormously enlarged,

reaching as far down as the umbilicus. A somewhat similar instance of early death is reported by Oestreich.<sup>3</sup> The child lived for a year and a half.

Osler<sup>4</sup> discusses the subject from the congenital aspect, and narrates the histories of three cases occurring in young children. In one, a boy aged 3 years, death resulted from an attack of acute colitis. At the post mortem the colon was

<sup>1</sup> *Annual of the Universal Medical Sciences*, 1893, vol. i. D 28.

<sup>2</sup> *Ibid.* 1892, vol. i. D—28.

<sup>3</sup> *Berliner klin. Wochenschrift*, 1893, p. 852.

<sup>4</sup> *Archives of Pediatrics*, 1893, vol. x. p. 111.

enormously dilated, holding fourteen pints of water; the greatest dilatation was in the neighbourhood of the sigmoid flexure. He had been troubled with constipation since birth. In the second case the boy was aged 10 years when first seen, and complained of a swollen and painful abdomen. His symptoms subsequently took the form of frequent attacks of pain and vomiting. For the relief of these laparotomy was performed, when it was found that the sigmoid flexure was the portion most distended. An artificial anus was made in this part, and the symptoms all subsided. In the third case the child was aged 7 months when first seen. At the outset it was noticed that its napkins were not soiled. The abdomen became swollen and tender. Relief had to be obtained by injections. Unless these were given daily, the belly would swell and the child vomit.

As illustrations of dilatation existing at a comparatively late period of life, the following cases may be referred to. Herringham<sup>1</sup> records the case of a man, aged 78 years, who had suffered all his life from constipation. Eleven days before death he failed to obtain any action of his bowels. His symptoms grew worse and the abdomen was opened, when it was found that perforation had taken place. At the post mortem the disease was found to consist in enormous dilatation of the sigmoid flexure; the intestine above and below was natural. Another very similar case is reported by Money.<sup>2</sup> In this instance the man was aged 55 years, and suffered from extreme dyspnoea, blueness of lips, nose, ears, and nail-beds, and general duskiness of the face and skin. At the post mortem the sigmoid flexure was found most markedly affected, and two large sacs existed, each far bigger than an ordinary dilated stomach. Several other cases are referred to by this author.

In most of these cases the bowel, in addition to being greatly dilated, is also considerably hypertrophied; so that associating this state of the bowel wall with the frequent congenital origin of the disease, it would seem reasonable to suppose that the condition was rather one of abnormal development of the part than the result of acquired pathological

<sup>1</sup> *Brit. Med. Journ.* 1894, vol. ii. p. 1240.

<sup>2</sup> *Trans. Clin. Soc. Lond.* 1888, vol. xxi. p. 103.

changes. It would, however, involve too extensive a discussion of the subject to pursue further the possible causes of this form of dilatation. It is of special interest to the surgeon purely from the clinical aspect.

**Treatment.**—From the cases recorded, it would appear that the best form of treatment to adopt in all but extreme instances is the regular use of water enemata, employed daily or at such periods as required; in some few cases aperients have answered. As long as relief can thus be obtained and no more serious symptoms develop, anything in the way of operation should be avoided. If, however, the distension interferes with the proper action of the heart, or impedes respiration, the most distended portion of the gut should be opened, its contents removed, and a fæcal fistula established.

CASE XCVIII.—*Congenital dilatation of the colon. Death.*

A boy aged 12 years had been subject to constipation since 6 months of age. On admission to St. George's Hospital he was emaciated. The eyes were sunken and the complexion of a bistre tint. The abdomen was enormously distended, and the peristaltic contractions of the intestine could be seen. During the three months that he was under observation his condition varied, often very suddenly. He would improve for a time, the bowel acting daily and the abdomen becoming soft. Then suddenly constipation and vomiting would come on without manifest cause. The attacks usually subsided in a day or two, but in one of them he died. There was never any obstruction. The treatment was varied, but with the exception of calomel, nothing seemed to do any material good.

*Post mortem.*—Great dilatation of the colon was found. No stricture or cause for obstruction could be found anywhere. There were numerous ulcers in the colon, due presumably to distension; the muscular coats were hypertrophied. (H. D. Rolleston and Warrington Haward, 'Brit. Med. Journ.' 1896, vol. i. p. 1326.)

**Abnormalities.**—The enormous increase within recent years of exploratory operations upon the abdomen, not to speak of the performance of operations for definite purposes and more especially for intestinal obstruction, renders it imperative that the surgeon should be familiar with some of the more commonly met with misplacements and malformations of the large intestine. The additional fact also that intestinal defects may of themselves give rise to symptoms resembling other affections, renders a knowledge of them still more important. Just to briefly illustrate what has been said, and to indicate the practical difficulties which the surgeon may have to encounter,



Lockwood<sup>1</sup> narrates two cases where an endeavour was made to open the colon for obstruction, but in neither could the bowel be found. It was subsequently ascertained that the failure was due to an absence of the colon from its normal position.

For practical purposes it is possible to divide the abnormalities of the large bowel into misplacements and those due to maldevelopment. It is probable that similar causes give rise to both. Intra-uterine inflammation, and deficiency in the processes of normal development may conduce on the one hand to the bowel not occupying its proper position, and on the other to a congenital malformation of the part. The existence of adhesions in any particular case would suggest the possibility of some foetal inflammation as a cause.

**Misplacements.**—1. *Of the whole bowel.*—Cases occasionally occur of transposition of the viscera, by which is understood the occupation of the left side of the body by organs normally situated on the right, and *vice versa*. Such conditions give rise to no symptoms, and as a rule are discovered somewhat accidentally. It is not difficult, however, to conceive the trouble which might arise should for any cause operation upon the large bowel be necessary. In a case recorded by Cheadle,<sup>2</sup> the heart was found to be situated on the right side; and this discovery led to the diagnosis of complete transposition of the stomach, liver, and spleen, from which it was inferred that the cæcum must be in the left iliac fossa and the sigmoid flexure in the right.

One of the most serious displacements of more or less of the large bowel is its passage through a congenital aperture in the diaphragm into the cavity of the thorax. In a less marked degree this constitutes a form of diaphragmatic hernia. In an extraordinary case reported by Eustace Smith,<sup>3</sup> the whole of the colon from the cæcum to the middle of the sigmoid had passed into the chest through a congenital aperture in the left ligamentum arcuatum externum. The cæcum remained in the abdomen just below the diaphragm. The rounded opening was about an inch in diameter. The case

<sup>1</sup> *St. Bartholomew's Hospital Reports*, 1863, vol. xix. p. 255.

<sup>2</sup> *Lancet*, 1892, vol. i. p. 803.

<sup>3</sup> *Archives of Pediatrics*, 1887, vol. iv. p. 385.

was that of an infant which, when first seen, suffered from intensely violent attacks of pain and dyspnœa. When these passed off the child was left pale and exhausted. In one of these attacks it died.

A peculiar course taken by the large bowel is reported by Tirard.<sup>1</sup> The condition had not apparently given rise to symptoms during life, but the child died at the age of  $3\frac{1}{2}$  years from cardiac disease. At the post mortem the cæcum was found attached by a distinct omentum to the edge of the fissure for the gall bladder, the bladder itself lying between the two layers. From the cæcum the large intestine ran in an oblique direction to the left iliac fossa, where it made a sharp bend to the right, and passed below the coils of the small intestine to the right iliac fossa, from which point, after making a gentle curve, it descended on the right side of the pelvis to the anus.

2. *Of the cæcum.*—The position of the cæcum is liable to considerable variation. Lockwood,<sup>2</sup> after describing a case where it was situated opposite the crest of the right ilium, discusses, from a developmental point of view, the various situations in which, from any defect in this process, the cæcum is liable to be arrested. Thus it may be located on the left side of the abdomen; or be free in the peritoneal cavity, being held in position by a mesentery; or it may be retained close to the cardiac end of the stomach, or in the right hypochondrium; or, lastly, any way between this and the iliac fossa. Numerous examples are given in illustration of each of these abnormal situations. A case is recorded by Fowler<sup>3</sup> where the cæcum was found immediately behind the liver. The patient was operated upon for appendicitis. Upon opening the abdomen and exploring its cavity the cæcum could not be found in the right iliac fossa, but the transverse colon was found to descend to the level of the pubes, a portion of it occupying the usual site of the ascending colon. On tracing this it led upwards to the cæcum, behind the liver.

3. *Of the sigmoid flexure.*—One of the commonest displacements of the sigmoid flexure is into the right iliac fossa, the bowel continuing into the rectum on the right side.

<sup>1</sup> *Lancet*, 1892, vol. i. p. 1131.      <sup>2</sup> *Brit. Med. Journ.* 1882, vol. ii. p. 575.

<sup>3</sup> *Annals of Surgery*, 1891, vol. xix. p. 160.

In reaching this position it is usual for the descending colon to take an oblique course across the abdomen, opposite the third, fourth, or fifth lumbar vertebra. In this form of displacement the cæcum is apt to be displaced from its normal situation, and the left iliac fossa usually becomes occupied by the small intestine. In a case reported by Dexter<sup>1</sup> of an adult male subject, the descending colon was found to pass from the splenic flexure across the abdomen, opposite the third lumbar vertebra, to the right iliac fossa. The cæcum, ascending and transverse colons were in their normal positions, while the small intestine alone occupied the left iliac fossa.

Other rarer and more remarkable variations in the misplacements of the sigmoid are described by Melsome<sup>2</sup> in the 'Proceedings' of the Anatomical Society of Great Britain and Ireland. Four examples are recorded. In three of these the variation was largely due to the greater size and length of the omega-loop.

That undue increase in the length and size of the sigmoid may give rise to symptoms is shown by a case recorded by Holt.<sup>3</sup> The child suffered from recurrent attacks of tympanites, which lasted sometimes for a week. At the post mortem the sigmoid portion of the colon was elongated and reflected upwards so as to cover the abdominal viscera almost completely.

**Maldevelopment.**—Included under this division is a class of cases which has already been discussed under the head of 'Idiopathic dilatation of the colon.' Many of these cases, it was shown, were probably congenital in their origin, and possibly due to some developmental defect.

Another class of cases exists, in which the bowel suffers from some abnormality in shape or structure. In this class are included pouches, sacculi, and diverticula. In a case recorded by Hamilton,<sup>4</sup> where the patient died from chronic phthisis, numerous diverticula were found in the sigmoid flexure like those commonly met with in the bladder. They consisted of a protrusion of the mucous membrane through

<sup>1</sup> *Boston Med. and Surg. Journ.* 1893, vol. cxxix. p. 479.

<sup>2</sup> *Journal of Anatomy and Physiology*, 1892-93, vol. xxvii. p. xxx.

<sup>3</sup> *New York Med. Journ.* 1886, vol. xliii. p. 225.

<sup>4</sup> *New York Medical Record*, 1888, vol. xxxiii. p. 721.

the muscular coat. In another case, reported by Hale White,<sup>1</sup> the descending colon, sigmoid flexure, and first part of the rectum contained a number of diverticula, mostly circular or oval, about a third of an inch in diameter, and transverse to the long axis of the bowel. They varied in depth, the longest being half an inch deep. There was no indication of disease. In a quite exceptional and remarkable case described and depicted by Fütterer,<sup>2</sup> a congenital diverticulum of the sigmoid flexure formed an enormous globe-shaped projection from the bowel wall.

Of a somewhat different character is a case recorded by Lockwood.<sup>3</sup> A man aged 57 years died of intestinal obstruction. At the post mortem the cæcum was found in the right hypochondriac region, beneath the liver. The colon coursed from the cæcum to the splenic flexure, and thence descended into the pelvis. The descending colon was double; both tubes were upon the same plane, the smaller one nearer the vertebral column: it contained no fæces. Each possessed appendices epiploicæ.

Deficiency in development is sometimes met with where, as in other parts of the intestinal tract, the bowel terminates in a cul-de-sac. Such malformations constitute one of the causes of obstruction met with in the new-born, where neither gas nor fæces pass *per rectum*. In a case recorded by Anderson,<sup>4</sup> the child passed its meconium through the umbilicus. It lived twenty-three days, and after death it was discovered that the large intestine, which was otherwise normal, terminated at the crest of the left ilium in a conical blind extremity.

In another class of cases the bowel, instead of ending blindly, communicates by a fistulous opening with the bladder or urethra. Hurd<sup>5</sup> records the case of a child which lived for fifteen months passing its fæces *per urethram*. At the post mortem the intestinal canal was found normal except at its lower part, where there was an entire absence of the rectum.

<sup>1</sup> *Trans. Path. Soc. Lond.* 1885, vol. xxxvi. p. 215.

<sup>2</sup> *Archiv für Path. Anat.* 1886, vol. cvi. p. 555.

<sup>3</sup> *Brit. Med. Journ.* 1882, vol. ii. p. 574.

<sup>4</sup> *Trans. Path. Soc. Lond.* 1891, vol. xlii. p. 128.

<sup>5</sup> *Boston Med. and Surg. Journ.* 1885, vol. cxiii. p. 294.

The descending colon, with its sigmoid flexure dilated and distended, was forced over to the right side, where it opened by a narrow rigid tube, an inch and a half in length by half an inch in diameter, into the prostatic portion of the urethra, just behind the pubic arch. Boyd<sup>1</sup> records a somewhat similar case, only the communication was between the sigmoid and the bladder. Gas and meconium were similarly passed by the urethra.

Possibly one of the rarest defects in development is recorded by Dodd.<sup>2</sup> A male infant lived for twelve weeks, suffering, on and off, from vomiting, constipation, and pain. At the post mortem it was found that the ascending and transverse colon were throughout but little larger than an ordinary lead pencil. The head of the cæcum was normal.

**Abnormalities of the ileo-cæcal valve.**—The only feature worthy of notice in connection with any abnormality of the ileo-cæcal valve is some lack of development, either partial or complete, in its two folds. The condition possibly exists more frequently than recorded examples would imply. There are no symptoms known to result from such a defect, and its discovery has only been made during life from the fact that enemata given *per rectum* have been found to produce a taste in the mouth of some ingredient contained within the injection, or that they have actually been ejected by the mouth. Birmingham<sup>3</sup> exhibited a specimen at the Royal Academy of Medicine in Ireland, where a mere rudiment of one of the flaps was present; and in the Hunterian Museum of the University of Glasgow a preparation exists which was obtained from a young lad who died of peritonitis. Clysters thrown up the rectum were in a few minutes vomited, the linseed oil appearing on the surface of the vomit.<sup>4</sup>

<sup>1</sup> *Edinburgh Med. Journ.* 1889, vol. i. p. 529.

<sup>2</sup> *Lancet*, 1892, vol. i. p. 1299.

<sup>3</sup> *Brit. Med. Journ.* 1893, vol. i. p. 241.

<sup>4</sup> *Museum Catalogue*, p. 87a; also *Brit. Med. Journ.* 1892, vol. ii. p. 1199.

## CHAPTER LIX

EMBOLISM AND THROMBOSIS OF THE MESENTERIC VESSELS<sup>1</sup>

It may not at first sight appear what interest any obstruction to the flow of blood in the mesenteric vessels can have for surgeons. Immediately, however, one grasps the fact that to cut off the arterial blood supply to a segment of the bowel is to paralyse that particular portion, it becomes at once evident that a patient whose mesenteric artery becomes suddenly blocked will be seized with acute obstruction.

The effect which a complete stoppage of the circulation has upon the bowel is best understood by comparing it with the more familiar and precisely similar conditions resulting from the strangulation of a loop of intestine beneath a band or through a hernial aperture. The sequence of pathological events which takes place in the latter instance has already been sufficiently described to need any further recognition here. The bowel will almost certainly become gangrenous, and perforation cause a fatal peritonitis. The condition therefore is a grave one, and calls for treatment without delay.

Embolism or thrombosis of the mesenteric vessels occurs mostly in late life, and is almost without exception, in the case of the arteries, associated with disease of the cardiac valves or with atheromatous disease of the aorta. The mesenteric vessels may be involved either at their origin, or more remotely in some of their smaller branches.

**Symptoms.**—Adenot,<sup>2</sup> who records a case of thrombosis of the inferior mesenteric artery producing gangrene of the colon, discusses the subject at some length. He quotes Kussmaul, who gives the following symptoms as those most frequently met with: a marked and sudden fall of temperature; violent abdominal pains of a colicky character; distension of the abdomen with tympanites; intra-abdominal effusion, and copious excessively fetid stools. He further indicates that it

<sup>1</sup> I am indebted to Dr. Rutherford for drawing my attention to a valuable paper by John Moyes in the *Glasgow Medical Journal* for 1880, vol. xiv. p. 485, on 'Embolism of the Superior Mesenteric Artery.' A good bibliography is appended.

<sup>2</sup> *Revue de Médecine*, 1890, vol. x. p. 267.

is possible by the character and continuous flow of blood passed *per rectum* to determine which of the two mesenteric vessels is involved. If the blood is decomposed the embolus is situated in the superior mesenteric; if on the other hand it is fresh the inferior mesenteric is involved. Again, the situation of the pain is considered of assistance. Thus when an itching and burning pain is complained of about the anus, it is the inferior mesenteric; when the pain approaches the region of the umbilicus it is the superior.

Of these symptoms the passage of blood and the rapid fall in the temperature are the most significant. The quantity of blood passed depends, however, upon the magnitude of the vessels obstructed. In a case recorded by M'Carthy,<sup>1</sup> no blood was passed; but in this instance it was not the trunk of the artery which was involved but its arterioles; emboli were discovered in several terminal branches of the superior mesenteric. The case was that of a man aged 77 years, who was admitted into hospital for symptoms resembling those of acute intestinal obstruction. He was seized with severe pains in the right hypogastric region, vomiting set in and lasted for six days, during which time there was no action of the bowels, and neither flatus, blood, nor mucus was discharged *per anum*. He had the typical abdominal face and a feeble pulse. The abdomen was neither tender nor tense; distended coils of intestine could be seen; there was dulness in both flanks. Laparotomy was performed, and a perforation discovered in an intensely congested and livid coil of ileum about twelve inches from the ileo-cæcal valve. The mesentery, which was loaded with fat, was slightly ecchymosed, and the blood vessels leading to the collapsed and congested bowel were filled with clot. The aorta was found at the post mortem to be very atheromatous.

The blood exuded may not find its way into the bowel, but may form collections in the bowel wall or in the mesentery, and should this take place to any extent it may lead to the possibility of a tumour being felt through the parietes. Such was the case in the patient whose report is given in detail below.

**Thrombosis of the superior mesenteric vein.**—The following

<sup>1</sup> *Lancet*, 1890, vol. i. p. 646.

interesting case is the only one I have met with illustrative of involvement of the mesenteric vein and not the artery. The case is described by McWeeny,<sup>1</sup> and as it adds another to those numerous causes of sudden abdominal pain ending in rapid collapse and death it is worthy of note. The patient was a girl who after recovering from an attack of erysipelas was suddenly seized with violent pains in her stomach, became collapsed, and died in the course of a few hours. At the post mortem great dilatation of the tributaries of the superior mesenteric vein was found, with intense congestion of the portion of the bowel from which the veins sprung; this was in a state of hæmorrhagic infarction, and there seemed to have been a weeping hæmorrhage into the bowel, for it contained about a quart of blood.

CASE XCIX.—*Embolism of the inferior mesenteric artery, with symptoms of obstruction: laparotomy. Death.*

A man aged 51 years, while lifting a heavy bar of metal, felt a peculiar sensation in the lower part of his abdomen. This was followed by pain and a feeling of weakness, which necessitated his leaving his work. On the same evening he passed from a pint to a pint and a half of blood by the bowel, and the following morning he again passed about half a pint. He was away from work for a week, during which time he experienced, more or less constantly, colicky pains in the abdomen, and suffered from constipation, necessitating his taking a purgative. He returned to work, but only for four or five days, the general weakness and abdominal pain compelling him to give up. From this period up to his admission into hospital he had had no movement, and purgatives administered had had no effect. He had been vomiting more or less the whole time, and colicky pain, variable in severity, had been a constant source of trouble.

On admission three weeks after he was first seized, he looked somewhat pale and exhausted; the tongue was foul and the temperature sub-normal, and it remained so, gradually falling, up to the time of his death. The abdomen on inspection was found to be markedly distended. In the left iliac fossa a hard mass about the size of a large orange could be felt.

Two days after admission laparotomy was performed. The mass in the iliac fossa was due to a large decolorised infarction in the mesentery of the sigmoid flexure. There were two infarcts also in the mesentery of the small bowel. The ascending, transverse, and descending colons were enormously distended and very dark in colour; the walls appeared to be thinned by the distension to which they had been subjected, and they had a doughy feel to the touch. The small intestines were red and deeply

---

<sup>1</sup> *Dublin Journal of the Medical Sciences*, 1894, vol. xcvii. p. 169.



injected, which, together with the more recent appearances of the infarcts, proves that the inferior mesenteric artery was first affected. The patient sank about twenty hours after the operation. No post mortem was allowed. (Munro, 'Lancet,' 1894, vol. i. p. 147.)

---

## CHAPTER LX

### THE VERMIFORM APPENDIX. ANATOMY. APPENDICITIS

THE vermiform appendix represents a portion of the intestinal canal which, at an early period of foetal life, was a continuation of, and differed little from, the colon. At a later period of intra-uterine life its development ceased, and it then became merely an appendage of the cæcum, with an inherent tendency to retrogress and degenerate.

As met with at birth and throughout the rest of life, it appears as a wormlike organ, variable in its shape, size, and situation, and connected with the cæcum usually on its inner and posterior surface, close below the entrance of the ileum.

Ribbert,<sup>1</sup> in his investigation upon the appendix, points out that retrogression manifests itself as age advances in three ways: reduction in length, alterations in histological structure, and obliteration of the canal. In early life it possesses a canal continuous with that of the cæcum, but in later years this connection is sometimes cut off, and in many cases partial or complete occlusion takes place. Between the tenth and thirtieth year Ribbert found that 14 per cent. of the cases examined presented partial occlusion, and between the sixtieth and eightieth year as many as 55·5 per cent. According to Struthers,<sup>2</sup> 'about  $\frac{1}{4}$  inch may be given as a fair average diameter taken at the middle. . . . The diameter usually diminishes a little distally, but not always; the end is usually blunt-pointed, sometimes quite blunt, sometimes, but not often, sharp-pointed.' In length the appendix varies from an inch to nine and a half inches, its average length being about three and a half inches. In thickness it is about equal to a goose quill.

<sup>1</sup> Virchow's *Archiv*, 1893, Bd. cxxxii. p. 66.

<sup>2</sup> *Edinburgh Med. Journ.* 1893, vol. xxxix. part i. p. 290.

Attached to one border, for a variable extent, is its mesentery, which usually connects it with the ileum or is continuous with its mesentery. In the mesentery are contained the blood vessels, lymphatics, and nerves. The appendicular artery is derived from the ileo-colic branch of the superior mesenteric. It passes usually along the free border of the meso-appendix, giving off branches in its course. The nerves are derived from the superior mesenteric plexus, a derivative of the solar plexus.

In shape the appendix presents considerable variation, being straight, curved, bent, or twisted like a corkscrew. These variations may in some cases be due to the shortness of the meso-appendix, in others to the undue length of the appendix.

Of most practical interest to the surgeon is the situation of the appendix. This particular part of the anatomy of the organ has been exhaustively considered by J. D. Bryant<sup>1</sup> in a valuable contribution on the 'Relations of the Gross Anatomy of the Vermiform Appendix to some Features of the Clinical History of Appendicitis.' The observations are based upon the examination of 144 cases. Giving only five out of the fourteen different situations recorded, the appendix was found directed upwards in thirty-four cases, behind the cæcum in thirty-two, downwards and inwards in twenty-eight, into the true pelvis in twenty-one, and upwards and inwards in nine; thus leaving only twenty cases to be allocated among the remaining nine situations. In three only of these 144 cases was the appendix situated extra-peritoneally—that is to say, it lay behind in the retrocæcal or post-peritoneal connective tissue.

In structure the appendix resembles the other parts of the intestine in possessing four coats, but differs somewhat in its minute anatomy. In most instances the peritoneum covers the organ completely; when it does not do so, the uncovered part is connected with the post-peritoneal connective tissue. The muscular coat is somewhat irregular in its distribution. Longitudinal fibres are found forming a uniformly disposed external sheath; deeper is an internal and thicker coat of unstriped circularly placed fibres combined with fibrous tissue. Between the muscular and mucous coats is a layer of connective

<sup>1</sup> *Annals of Surgery*, 1893, vol. xvii. p. 164.

tissue constituting the submucous tunic. Lastly, a mucous membrane forms the lining of the canal. In this latter are a number of solitary lymph follicles. The abundance of lymphoid tissue in the mucous membrane, especially at an early period of life, has led to a comparison between this part and the tonsils, and also suggested a possible source of inflammation in the organ.

In early and middle life the appendicular canal usually communicates by an aperture with the cavity of the cæcum, the mucous lining of the two parts being continuous. The presence of anything like a fold constituting a valve to the orifice of the canal is disputed.

Mucus is secreted by the lining membrane, and constitutes one of the products contained within the canal. It is interesting in connection with the question of contents of the canal to refer to Bryant's paper.<sup>1</sup> Out of 124 autopsies made for other reasons than disease of the appendix, 67 per cent. contained abnormal material; fæcal matter, either soft or hard, was present more frequently than anything else, being noted in 52 per cent. of the male and in 35 per cent. of the female cases. In no instances were there other than fæcal substances, or products dependent on inflammation, present in these cases. Grape seeds, cherry stones, and bodies foreign to the intestine were not found at all. As regards the relation of age to contents, from 30 years to 50 is the period of life in which material of some kind is most frequently found.

**Inflammatory affections of the appendix.—Appendicitis.**—Ten years or so ago, a few lines would have sufficed to say all that was supposed of any special interest to the surgeon regarding the inflammatory affection of the vermiform appendix. Now, however, it is difficult to know how to condense within the reasonable space of a few pages what every surgeon should know, so rapid and extensive has been the advance made in this particular subject.

By appendicitis is to be understood an inflammation of the appendix vermiformis; the initial lesion may not be inflammatory, but inflammation arises sooner or later.

Much has been written in recent years on the subject, so much indeed that not a little confusion has been caused by

<sup>1</sup> *Annals of Surgery*, 1893, vol. xvii. p. 172.

the various discussions over the classification of the different lesions met with, the causes of such lesions, and the proper treatment to adopt. This has largely arisen on the one hand from the extensively varied natural course which the disease may run, coupled with the equally varied and numerous complications which may at any time arise; and on the other hand from a too hasty endeavour on the part of writers to formulate opinions, and promulgate advice based upon a too limited experience.

To the Americans, and more particularly to Fitz and McBurney, belong the credit of first indicating the true clinical significance of inflammatory affections of the appendix. Pathologists had long taught the frequency with which the organ was found diseased, but it is only within comparatively recent years that light has been thrown upon the symptoms to which it gives rise and the possibility of successful treatment demonstrated. Pathologists knew of the diseased organ: clinicians knew of an inflammation frequently located in the right iliac fossa, but it has been left to comparatively modern investigation to demonstrate the connection between the two; that the one is the cause and the other the effect.

No contribution to the subject in recent years, I venture to think, can compare with, or claim higher commendation than that of the American surgeon George R. Fowler,<sup>1</sup> who, on the basis of no fewer than 169 personally observed cases, has carefully searched into, tabulated, and reasoned out facts which constitute the most reliable foundation for any discussion of the subject. I must personally acknowledge the value this contribution has been to me in endeavouring to present a clear and concise review of the disease. In common with most surgeons, several cases have come under my own observation; but I should fall into the very error which I have already condemned if I made these the basis of generalisations, apart from the large groups of recorded cases, such as have been presented by this distinguished surgeon.

**Pathology.**—The classification of inflammatory diseases of the appendix has constituted one of the difficult questions connected with the subject, and its difficulty largely arises

<sup>1</sup> *Annals of Surgery*, 1894, vol. xix. pp. 4, 146, 327, 475, 546.

from the fact that what has sometimes been described as one form of the disease has been merely a stage in the process of another. If such conditions are excepted as arise from some sudden obstruction, mechanical or pathological, to the arterial supply of the organ, all other conditions may be said to be stages in the progress of some initial inflammation set up by an exciting cause most probably located within the appendicular canal. Thus a slight general inflammation of the mucous membrane would constitute a catarrh or endo-appendicitis; should this extend into the parietes it would constitute an interstitial inflammation; further progress would involve the peritoneum and produce a peri-appendicitis which may end in remaining a local peritonitis or extend and produce the general form of the disease. Further, it is not difficult to trace the possible variations which would accrue from differences in degrees of acuteness or chronicity. Thus an acute inflammation would lead to sloughing or gangrene: pus might be produced, and be pent up within the canal or form a limited abscess around the organ. Such abscess might burrow in various directions, or burst into the general peritoneal cavity. Again, an acute inflammation, such as would cause ulceration, might lead to perforation; and should no adhesions have formed sufficient to shut off and localise the inflammatory process the peritoneal cavity would be opened into.

Other pathological lesions would depend upon the particular position occupied by the appendix. Thus its close proximity to the iliac vessels may cause phlebitis, or thrombosis of the iliac vein: or the vessels may be ulcerated into, and a fatal hæmorrhage result. When the appendix lies across the psoas muscle, inflammation may extend to that muscle, giving rise to flexion and fixation of the thigh upon the abdomen. When the appendix is long and hangs into the pelvis, it may form attachments to the bladder or rectum, and subsequently establish a communication with either. Abscesses have been known in cases of this nature to be discharged either *per urethram* or *per rectum*.

More distant lesions are sometimes found, mostly, however, of a pyæmic nature, and the result of septic absorption. Thus instances are occasionally forthcoming of abscess formation

in the liver. In a case reported by Hector Cameron,<sup>1</sup> death resulted from multiple abscesses in the liver. The patient during life had had well-marked pyæmic symptoms, and an enlargement of the liver which was easily observed.

Lastly, at any stage the inflammatory process may subside, leaving the parts either healthy, or in a condition to light up again with any suitable provocative. This latter class constitutes the so-called recurrent or relapsing form.

It will thus be seen how many phases a purely inflammatory process may present and how numerous become the divisions into which the disease might be divided. For practical purposes it is possible and certainly wise to attempt some sort of a classification, but it is better to remember that a pathological condition is being dealt with which, while it may assume a simple form at one period, may at any moment become one of extreme gravity. The best possible division would be one based on definite causes, as tubercular appendicitis; simple ulcerative appendicitis; appendicitis due to a foreign body; appendicitis from arterial embolism or thrombosis; appendicitis from kinking, torsion, or compression; specific microbial appendicitis, &c. Such a classification, however, is impossible from the fact that there are no premonitory signs, or symptoms pathognomonic of any one of these causes, nor are there pathological lesions peculiar to them. Whatever therefore be the nature of the cause, the basis of classification must be either definite clinical symptoms or distinct pathological lesions. The latter may answer the purpose of the pathologist, but until our knowledge has considerably increased in the power of differentiating symptoms, we can probably get no further than to consider the cases under the three heads of acute, subacute, and chronic or relapsing. Even such a classification conveys but very imperfect information, for at the outset of any case we can never tell under which heading it should be classed, and, what is still more important, the name in no sense indicates the real gravity of the case. These facts will become clear as the disease is discussed.

**Etiology.**—The various causes which may prove the direct incentive to an attack of appendicitis have already been in-

<sup>1</sup> *Trans. Path. and Clin. Soc. Glasgow*, 1895, vol. v. p. 125.

dicated, but a little more detailed description of them is necessary.

Many causes give rise to inflammation in the appendix which would have no similar effect in the case of the cæcum. The reason of this is probably to be sought in the natural predisposition which an ill-developed and degenerative organ possesses.

*Bacillary origin.*—The part played by a specific micro-organism has been much lauded of late: and the frequency with which the *bacillus coli communis* has been found renders it extremely probable that the disease in many cases owes its origin to this microbe. Whether its simple presence can actually initiate the disease without the coexistence of some primary lesion in the part may be open to question; but once the part is weakened from some cause, it is more than probable that the entrance of this bacillus into the tissue of the organ lights up some or all of those conditions which are included under the general term of appendicitis. The bacillus, it must be remembered, is a constant occupant of the intestinal canal, and as such has ready access to the appendicular canal. It is therefore practically always on the spot, and ready to attack, and multiply in, any tissue that has from any cause become more or less devitalised.

In addition to this particular bacillus, others have been discovered. It is quite possible therefore that in some cases inflammation has arisen from pathogenic microbes other than that referred to. But in favour of the preponderating effect of the *bacillus coli communis* is the fact that it is almost always present, and in some cases it is the only one found, it being possible to obtain a pure cultivation of it from the infected part.

Among some of the weakening causes, and therefore preparatory conditions for the entrance of the microbe, are such as interfere with the blood or nerve supply of the part. Thus any acute kinking or bending of the appendix, or torsion of the mesentery may interfere with the blood supply. Similarly embolism or thrombosis of the vessels would effect a like result. Should any of these strangulating or occlusion effects take place at the base of the appendix, the whole organ would become gangrenous. Short of this any degree of necrosis may

be met with. It is hardly possible to suppose that the mere necrosis of the whole or part of the appendix should give rise to serious symptoms; rather must it be that the devitalised part becomes infected and so the inflammatory process is started.

Another weakening cause is probably to be found in the irritative effects of material contained within the appendicular canal. Possibly as a predisposing or actually exciting cause the contents of the canal play but a slender part, for it has already been shown (see page 491) that it is extremely common for fæcal material to be found in appendices, in cases where there has been no lesion centring in that organ. And as regards foreign bodies, their presence in the canal must be considered rather in the light of curiosities than as playing any part in the production of disease. Out of the 169 cases investigated by Fowler, in only two was a foreign body found. One of these contained a true enterolith, and the other a gall stone. Much difference, however, exists in the nature and consistency of the fæcal accumulations found. In most instances they are more like small lumps of putty, but not infrequently some are met with hard and almost brittle. It is not difficult to understand how these latter might in some cases prove the cause of ulceration and so create a weakened spot for the incursion of microbes.

The retrogressive tendency which the canal has to become obliterated, either partially or completely, results sometimes in the inclusion of material which sooner or later produces its deleterious influences upon the involved portion.

Extension of inflammation from the mucous membrane of the cæcum to that of the appendix probably takes place in some cases and it is likely that in some of these cases occlusions, partial or complete, of some part of the canal results, with consequent distension and increased inflammation of the distal portion.

Indiscretion in diet and over-exertion are ascribed as causes capable of evoking a fresh attack in chronic or relapsing cases. Such a cause as the latter probably produces its effect by tearing or stretching adhesions.

Among rare causes of appendicitis must be mentioned tubercular and typhoid ulceration. Cases of actinomycosis



are recorded. I had the opportunity of seeing an example of this disease in the wards of Scherning in the Commune Hospital at Copenhagen. Every effort by operation had been made to get rid of the disease, but still the wound in the iliac region copiously discharged pus with quantities of the micro-organism in it. The patient was greatly emaciated, and died from exhaustion. A case is also recorded by Fairweather<sup>1</sup> in which, although death ensued, considerable improvement appears to have resulted from the use of the iodides of potassium and sodium.

The large amount of lymphoid tissue in the mucous and submucous coats may play a part in initiating the disease in certain cases. The similarity existing between these lymphoid follicles and the tonsils has led to the belief that inflammatory affections may similarly attack the former. It is possible that the supposed rheumatic origin of the disease finds its explanation in the presence of this tissue.<sup>2</sup>

A factor considered of some importance in regard to the effect it has upon the bacillus coli communis, is the condition of the contents of the large intestine. In any disease of the bowel, but more particularly in chronic constipation, the bacillus has been found to assume a more virulent character. It is thus liable, under any weakened condition of the appendix, to more readily infect it.

---

## CHAPTER LXI

### APPENDICITIS (*continued*). SYMPTOMS AND DIAGNOSIS

**Symptoms.**—In the larger proportion of cases the symptoms are both characteristic and distinctive of the disease. In the matters of sex and age it shows features of marked proclivity.

**Sex.**—In the 169 cases recorded by Fowler the disease occurred 142 times in males and 35 in females—that is to say, in the proportion of four of the former to one of the latter. This represents, with few exceptions, what has been found to be the ratio in other series of published cases.

<sup>1</sup> *Brit. Med. Journ.* 1896, vol. i. p. 1555.

<sup>2</sup> *Ibid.* 1895, vol. i. p. 1142.

*Age.*—The disease most frequently occurs between the years of 10 and 30; forty-three of Fowler's 169 cases were between 20 and 25. Roughly it may be estimated that 50 per cent. of the cases occur between the years of 10 and 25. One of the youngest cases is that of a child aged  $2\frac{1}{4}$  years, recorded by Churton.<sup>1</sup> It died of perforation of the appendix. The oldest of Fowler's series is 68 years.

*Pain.*—The most prominent symptom and usually the first is acute pain, felt, in the majority of instances, at the time of seizure and for half an hour or longer after in the region of the umbilicus or epigastrium. It is likened to cramp. After fixing upon the upper part of the abdomen, it gradually diffuses itself over the entire region, and finally becomes located in the right iliac fossa. Its occurrence in this particular region renders it one of the special features of the disease.

The significance of the pain is both of pathological and physiological interest. It doubtless arises in the first place from a reflex through the mesenteric plexus, the solar plexus, and so to the spinal nerves which radiate from the lower dorsal and upper lumbar regions; but what proves the direct exciting cause is not so easy to determine. Rushmore<sup>2</sup> believes that the initial symptom of pain really indicates, not the commencement of the disease, but its last stage; that, in fact, the inflammation has reached the peritoneum. Jessop<sup>3</sup> believes that there are several cases in which pain signifies an endeavour on the part of the muscular tunic of the appendix to eject from the canal some offending object within it, or some of its pent-up contents. To pain so caused the term 'appendicular colic' is applied. The cases quoted by the latter surgeon would seem to reasonably support the view that there are cases which may be considered as parallel with the passage of gall stones down the gall duct, or a renal calculus down the ureter. A portion of the appendix becomes gradually distended with mucus, till the muscular coat is stimulated to powerfully contract and endeavour to empty its contents through the narrowed

<sup>1</sup> *Brit. Med. Journ.* 1895, vol. i. p. 500.

<sup>2</sup> *Annals of Surgery*, 1894, vol. xix. p. 580.

<sup>3</sup> *Brit. Med. Journ.* 1894, vol. i. p. 627.

channel at its proximal end. If this is effected the colic disappears, until a reaccumulation leads to a repetition of the same process. As, however, the lesion causing the pain is really a pathological one, no diminished importance can be attached to it, for at any time the condition may pass from a non-inflammatory one into a true appendicitis, with all the dangers incident to that affection when arising from other causes.

Inasmuch as the pain which is latterly felt is seated over the appendix, any abnormal position of the cæcum will correspondingly affect the locality of the pain. In not a few cases this has been illustrated by pain in the left iliac fossa and beneath the liver, the appendix having been found in these situations.

*Nausea and vomiting.*—Shortly after the seizure with pain the patient frequently vomits or complains of nausea. The symptom is probably more connected with the degree of acuteness of the pain than with anything else, as it usually passes off, only to return if any grave lesion occurs, such for instance as perforation or intestinal obstruction.

*Temperature and pulse.*—The temperature is no fixed feature. A chill or rigor is but rarely present. In most instances there is some rise at the onset, which, however, may soon pass off, and usually does so in the course of two three days, in cases that are likely soon to recover. A continuous rise will indicate increasing extension of the inflammation with possibly pus formation, or approaching perforation.

There are, however, numerous exceptions to such a course. Perforation has taken place when the temperature has fallen to normal; and a fetid abscess has been opened after the temperature has become reduced. A temperature, however, which continues to rise or remain elevated after the third or fourth day, should be watched with some anxiety.

The pulse as a rule, with, however, many exceptions, follows pretty much the temperature in rising at the onset, and subsiding in mild cases in the course of three or four days. In cases, however, which are progressive, the pulse shows a greater constancy in its action than the temperature. Increase of rapidity after the third or fourth day must

be counted as a grave indication, notwithstanding the fact that such a rise is co-existent with a fall in the temperature. In cases of perforation the pulse rate is usually high. The difficulties associated with the question of the temperature and the pulse are concisely expressed by Fowler :<sup>1</sup> 'A lowering temperature and lessening pulse rate is not inconsistent with impending ulceration, perforation of the appendix into an unprotected peritoneal cavity, complete gangrene of the organ, or rupture of an appendicular abscess into the cavity of the peritoneum.'

*The bowels.*—In some cases the attack has been preceded by a period of constipation, which may give way during the first hours of the seizure to more or less of diarrhœa. In other instances diarrhœa precedes the attack; while in a third class there has been no intestinal trouble.

During the attack the bowels may become constipated, but often normal motions take place. Should the inflammation extend to the cæcum, so as to completely paralyse the walls of that portion of the intestine, obstruction would result with the passage of neither fæces nor flatus.

*Tenderness.*—A somewhat important symptom is the tenderness elicited by pressure over the seat of the disease. At the earliest stage this symptom is frequently located at one particular point, situated at the junction of a line drawn from the umbilicus to the anterior superior iliac spine with the outer border of the right rectus (McBurney's point). Pressure at this spot causes pain of variable degrees of acuteness. As the disease progresses and inflammation extends, the area of tenderness also enlarges, and pain may be elicited by pressure anywhere over the iliac fossa and sometimes more generally over the abdomen. Any variation in the normal position of the cæcum and appendix will affect this region of tenderness, since palpation of the abdominal parietes only causes pain by reason of its direct effect upon the inflamed area.

In cases of a long appendix hanging into the pelvis, tenderness may be found on rectal or vaginal examination; but under ordinary circumstances this method of investigation affords little or no assistance.

It occasionally happens, in palpating the abdomen, that the

<sup>1</sup> Page 153.

right rectus muscle is felt to be more or less rigid. This is due to the involvement of the peritoneum lining it. Similarly, should the appendix rest upon the psoas, some inflammatory irritation of the muscle would lead to flexion and fixation of the thigh upon the abdomen.

*Tumour.*—Manipulation of the parietes may reveal the existence of a swelling. This is more likely to be detected if the abdominal walls are relaxed by the administration of an anæsthetic. It is a comparatively common symptom, although in many cases it may not amount to more than an ill-defined fulness. When not prominent it is most probably due to the adhesion and matting of the parts, with possibly some thickening the result of œdema. In more evident indications of a swelling, the cause is probably an abscess.

In addition to the localised swelling in the iliac fossa, the abdomen itself is sometimes distended and tympanitic on percussion. This is probably due to some commencing peritonitis; but as the other symptoms subside, it too disappears.

The patient's general condition soon shows considerable change. Loss of appetite leads to emaciation, the face becomes pale, the tongue coated, and the patient presents the aspect of being acutely ill.

A symptom occasionally, though rarely, present is some pain connected with micturition. Its origin is usually due to the irritative effects of an appendicitis situated in the pelvis. Barling<sup>1</sup> mentions having met with it in five cases, all males.

Occasionally the patient suffers from constantly recurring chills or rigors; such symptoms indicate septic absorption, and may result in abscess formation in the liver. In a case recorded by Harte,<sup>2</sup> while the early symptoms were those of appendicitis, the later ones and those which caused death were all directed to the region of the liver, and to pyæmia. At the post mortem the liver was found slightly enlarged, and filled with a large number of metastatic abscesses.

In progressive cases—those in which the inflammatory process does not subside after the first three or four days—

<sup>1</sup> *Brit. Med. Journ.* 1895, vol. i. p. 1136.

<sup>2</sup> *Annals of Surgery*, 1894, vol. xx. p. 423.

other symptoms arise in connection, in most instances, with the formation of an abscess, which usually tends to find its way to the surface. The skin in the loin or inguinal region becomes reddened and œdematous, with increased tenderness. In cases where the abscess bursts without being previously opened, it may burrow between the parietal muscles and evacuate itself at some distance from the seat of the disease. In one such case I found the abscess discharging itself through an opening over the left iliac fossa. In enlarging the orifice, an aperture in the muscles was detected which communicated with a sinus leading across the abdomen to the usual seat.

Perforation of the appendix sometimes takes place in cases where the disease is supposed to be subsiding or quiescent. There is then a sudden outbreak of acute symptoms, with all the usual accompaniments of commencing acute peritonitis. The bursting of an abscess into the general peritoneal cavity will also be associated with an exacerbation of the symptoms.

Abscesses which burst or have been opened sometimes leave intractable discharging sinuses. The purulent matter has frequently a fœcal odour, showing that in all probability there has been or still is a fistulous communication with the bowel. In some of these cases a fœcal concretion is found at the bottom of the sinus. Two such fell under my own observation.

Where after the lapse of three or four days all symptoms subside, it may be hoped that the patient is convalescent. However, as regards the seat of disease, one of two results may be happening: either there is a complete return to the normal healthy condition, or there is a perpetuation of some chronic inflammatory process which will lie dormant until excited into renewed activity by some fresh agency. The cases included under this latter class constitute those known as chronic, recrudescient or relapsing.

In instances of this chronic class it is not infrequent to find that, while all prominent symptoms have disappeared, there lingers a variable degree of tenderness about the iliac fossa when deep pressure is made upon it. Or it may be that as the result of excessive exercise, or indiscretion in diet, the patient is himself conscious of some discomfort in the region. From either of these latter causes, as well as from others un-

PLATE XXIV.



Fig. 63—CÆCUM AND VERMIFORM APPENDIX.—The piece of whalebone indicates a perforation which resulted from a concretion, and led to acute peritonitis. (H.J.M., Glas.)





known, an acute attack is sometimes set up, when all the symptoms from which the patient suffered in the initial attack are repeated, sometimes to a less degree of severity, but as frequently to a greater.

These recurrent or relapsing attacks take place at variable intervals of time. Sometimes a patient may suffer from several attacks in a year; in others, again, the frequency with which they recur renders the patient a chronic invalid. The ultimate result in these cases it is never possible to predict. Sometimes after a series of attacks the patient ceases to be any longer troubled with a repetition; in other cases an attack finally comes which ends in acute peritonitis or acute intestinal obstruction.

**Diagnosis.**—Few intra-abdominal cases present less difficulty in diagnosis than those of typical acute appendicitis. A patient seized with sudden acute pain located at first in the neighbourhood of the umbilicus, and subsequently, or sometimes at the outset, in the right iliac fossa; with nausea and vomiting; with tenderness in the region of the appendix; and with some rise of temperature and acceleration of pulse, will, in nineteen cases out of twenty, be the subject of an acute attack of appendicitis. At a later stage some fulness may be detected in the right iliac fossa.

It is right to indicate here that in examination of the abdomen by palpation all due care and gentleness should be employed in making pressure upon the seat of disease. Where the adhesions which shut off a localised abscess are recent, they are likely to be slender and easily broken down. Hence it may easily happen that an abscess ruptures into the general peritoneal cavity. Such an accident during examination would be marked by a sudden diminution in the feeling of resistance, and in the partial disappearance of the swelling. A case is recorded by Daniel<sup>1</sup> where this accident happened. With commendable promptitude the abdomen was opened, and the extravasated pus removed by irrigation and sponging. The patient made an uninterrupted recovery.

The association of sudden acute pain with vomiting and nausea in cases of hepatic or nephritic colic may sometimes mislead. There is, however, usually the absence of any

<sup>1</sup> *Brit. Med. Journ.* 1894, vol. ii. p. 531.

marked distant reflex pain such as is peculiar to either of these conditions, and the tenderness in the seat of the appendix is absent in the passage of biliary or renal calculi.

A case of a somewhat exceptional character was transferred to my male ward as one of abscess from appendicitis. The swelling presented the characters and occupied the position of an appendicular abscess. The history of the case also lent support to the diagnosis. However, on opening the abscess I came upon a fish bone which had apparently worked its way out through the large bowel near the commencement of the ascending colon.<sup>1</sup>

Mistakes are liable to be made when the cæcum and appendix are not normally situated in the right iliac fossa. Other symptoms being typical, tenderness and pain located in the left iliac fossa, or even beneath the liver, should lead to the suspicion of an abnormally disposed appendix.

Cases of intestinal obstruction have been mistaken for appendicitis, and in some of these the great similarity of symptoms renders it very difficult, if not impossible, to differentiate. Fowler records three examples. In one the patient was found to have the ileum strangulated by a diverticulum. In a second the small intestine had been drawn down by old adhesions into the pelvis; and in the third there was a strangulated internal hernia. In all three of these cases the misleading feature was the location of the pain in the right iliac region.

Cases have occasionally been mistaken for typhoid fever, and as such admitted into hospital. The converse also has occurred. A careful examination, however, usually reveals the true nature of the affection.

The clinical history of only two cases is given—one acute, the other relapsing. The excessive variability which exists in the mode of onset as well as in the progress of the disease renders it impossible to present any illustration which can be called in any way specially representative.

CASE C.—*Acute appendicitis: abscess formation: incision. Recovery.*

W. B., aged 27 years, awoke at two o'clock on the afternoon of Friday, July 17, on account of a colicky pain in the umbilical region, which also

---

<sup>1</sup> *Trans. Path. and Clin. Soc. Glasgow.* 1895, vol. v. p. 197.

passed up and down the abdomen. He took a teaspoonful of medicine given him, which he soon vomited; the pain, however, in the abdomen ceased. On the following morning, Saturday, the 18th, a second and quite different variety of pain seized him. It was of a constant, throbbing, cutting character in the right iliac region. The umbilical colicky pain also returned at intervals. He was now confined to his bed. He did not vomit, and took but scanty nourishment; the bowels moved once scantily. When admitted into hospital on Monday, the 20th, examination of the abdomen revealed an area of exquisite tenderness, about three by three inches, chiefly in the right iliac region, but extending into the hypogastric region. There was a marked sense of resistance, with dulness on percussion, and a reddened condition of the skin quite sharply limited to the above area. Tongue coated, no appetite, bowels constipated, pulse 108, moderate and soft; temperature  $102.4^{\circ}$  F.

*Operation.*—A crescentic incision, with its convexity down and outwards, was made over the reddened area. The subcutaneous tissue and all the muscles of the abdominal wall were found densely infiltrated with serum, rendering them very firm. A sausage-shaped tumour was incised, when a muddy, fetid pus escaped with a few bubbles of gas, showing the existence of a small abscess cavity surrounding a central somewhat cylindrical body, which was the appendix lying at the bottom of the abscess, soft, dull, and greenish-white in appearance. The wound was irrigated with hot sterilised water, packed with iodoform gauze, and a quantity of absorbent antiseptic dressing applied. Recovery was uninterrupted. (Eisendrath, 'Annals of Surgery,' 1892, vol. xv. p. 364.)

CASE CI.—*Relapsing appendicitis: appendicectomy. Recovery.*

C. G., an unusually well-developed and healthy-looking young man of 21 years, suffered from four attacks of appendicitis within ten months. Two of these attacks were so severe as apparently to threaten life; two were much milder. The first attack began on June 4, 1889, lasted only a few days, and was subdued by rest and a few doses of an opiate. The symptoms were constipation, coated tongue, pain in the right iliac fossa, tenderness to pressure in the same region, a slight degree of abdominal distension, and slightly elevated temperature. The second attack began on June 14, 1889, after a sharp game at lawn tennis. It was a very severe seizure; the temperature ran up to and over  $103^{\circ}$  F.; the pulse was rapid, and vomiting was continuous for several days; there was marked constipation, a coated tongue, universal abdominal distension, tenderness, and tympanitic percussion note. Pain and tenderness in right iliac fossa were most acute. Patient, after being seriously ill for nearly a week, gradually recovered as before, being treated by rest, opiates, poultices, and limited diet. A third (very severe) attack occurred on October 7, and a fourth (mild) one on April 2, 1890.

*Operation.*—After the patient was well out of the fourth attack, and in what may be termed the quiescent period, appendicectomy was performed. The appendix was found much distended and deeply attached. In removing it there were considerable adhesions, both firm and slight, and a

good deal of oozing took place on their severance. The wound healed by first intention, and the patient was allowed to get about after a month's confinement.

The patient when seen a year after the operation was in perfect health, and had been so since the operation. (Alexander Napier and A. Ernest Maylard, 'Trans. Path. Clin. Soc. Glasgow,' 1891, vol. iii. p. 284.)

---

## CHAPTER LXII

### APPENDICITIS (*continued*). PROGNOSIS AND TREATMENT

**Prognosis.**—The many possibilities which exist at the outset of any appendicular attack render it impossible at this stage to predict what may be the ultimate issue. Excessive acuteness of the early symptoms does not necessarily imply increased gravity of the case; neither does mildness in their manifestation preclude the possibility of the gravest result.

The most favourable results may be expected, in cases of early subsidence of the symptoms, after twenty-four or forty-eight hours. If on the other hand the disease progresses, increase of the symptoms will be observed after the third or fourth day. The importance of the temperature and pulse on and after these days has already been referred to. Should both pulse and temperature fall, accompanied with a subsidence of other symptoms, a favourable result may be looked for. A falling temperature, however, accompanied by a rapid or rising pulse rate and little or no remission of the symptoms, should be considered as indicative of some gravity.

Increased tenderness or swelling in the iliac region indicates abscess formation. Evacuation of the abscess cavity may be followed by rapid recovery; there is, however, the possibility of a fistula remaining for some time.

When the patient has recovered from an attack, the question arises whether there is a complete cure or whether some inflammatory mischief remains. It may be considered indicative of the latter result when some undue tenderness lingers in the iliac region. In such cases a recurrent attack is only too probable at no distant date. The following remarks

by Treves<sup>1</sup> are of value in connection with the question of recrudescence: 'If a large series of cases of this affection be passed in review, it will be found that the number of instances in which there has been only one attack is much greater than that in which there have been several attacks. In a certain proportion of the examples of a single attack there has been an abscess, and the great majority of the subjects of typhlitis who have passed through the stage of suppuration are thereby rendered free from any further attacks. The cause of the trouble has been removed by the suppurative process. The abscess cavity may apparently heal, and what is improperly called a second abscess may form; but that does not as a rule represent any fresh mischief at the original seat of disease.'

Richardson,<sup>2</sup> in the 181 cases observed by him, met with 46 where there was the history of a previous attack; that is to say, a relapse took place in 25 per cent. of the cases. In Fowler's cases there were 35 which relapsed out of the 154—making therefore a very similar average.

**Prognosis in regard to operation.**—From certain aspects it is possible to express a tolerably definite opinion regarding the advantage or otherwise of operations. Most difficulty arises, if not positive error, when an attempt is made to compare, *in toto*, by statistics the relative advantages of purely medical treatment, and operative. Thus Fitz<sup>3</sup> gives a mortality of 11 per cent. in cases treated medically, and 40 per cent. for those surgically dealt with. The most superficial consideration could only deduce from such data the supposed advantage of medical treatment over surgical. If a comparison of the kind were to have any practical value, every case of a certain series should be dealt with medically, and every case of another series surgically. As a matter of fact, however, what really happens is, that the simple uncomplicated cases receive mostly purely medical treatment, while the severe and frequently complicated are relegated to the surgeon. If therefore any just appreciation of the value of operation is to be obtained, it can only be on the surgical treatment of

<sup>1</sup> *Brit. Med. Journ.* 1895, vol. i. p. 517.

<sup>2</sup> *American Journal of the Medical Sciences*, 1894, vol. cvii. p. 22.

<sup>3</sup> *Boston Med. and Surg. Journ.* 1890, vol. cxxii. p. 620.

cases which either fail to amend under medical treatment, or present features which it is deemed inexpedient to allow to run an uninterrupted course.

First as regards relapsing cases, it can be confidently asserted that the removal of the appendix will permanently remove the disease, and that this can be effected with a minimum degree of risk as regards the operation itself. The following statistics sufficiently attest this. In the 35 relapsing cases of Fowler's series,<sup>1</sup> 27 were operated upon during the quiescent period, and 8 during the acute stage. There were two deaths, and these were attributed, one to septic peritonitis which existed prior to operation, and the other to tubercular ulceration of the ileum. Treves<sup>2</sup> gives 32 cases of appendicectomy for relapsing appendicitis, with one death. Similar good results are recorded by other surgeons. The operation, therefore, undertaken by an experienced and skilled operator is a safe one and remedial.

Operations performed during the acute stage of the disease hold out a much less hopeful prospect. This, however, is largely affected by the conditions that are found at the operation. Thus in Morris's statistics<sup>3</sup> of appendicectomy there were 48 cases operated upon. In 28 there were neither adhesions nor exudation, and all recovered; in 9 there were adhesions but no exudate, also all recovered; in 11 there was present a purulent exudate, and 4 deaths occurred. In Richardson's cases, out of 88 operated upon when acute, 30 died. In Fowler's 119 acute cases there were 41 deaths, 4 of which were directly attributable to the operation.

The least that can be hoped for by operation is when peritonitis has already set in. Operation, however, holds out the only hope, and has proved successful. Lane<sup>4</sup> records a good result where there was general acute suppurative peritonitis, and McBurney<sup>5</sup> reports a similar success. Lockwood<sup>6</sup> also contributes a successful case, where acute general septic peritonitis followed upon gangrene or ulceration of the appendix. Moynihan<sup>7</sup> records the case of a boy aged 13, who had

<sup>1</sup> Page 570.

<sup>2</sup> *Brit. Med. Journ.* 1895, vol. i. p. 517.

<sup>3</sup> *Annals of Surgery*, 1893, vol. xviii. p. 377.

<sup>4</sup> *Brit. Med. Journ.* 1894, vol. i. p. 354.

<sup>5</sup> *Annals of Surgery*, 1893, vol. xviii. p. 42.

<sup>6</sup> *Brit. Med. Journ.* 1896, vol. i. p. 731.

<sup>7</sup> *Ibid.* p. 1387.

suffered for three and a half days from acute appendicitis, perforation occurring towards the end of the third day. The abdomen was opened by a median incision, and the peritoneal cavity, which was found to contain offensive pus, was thoroughly cleansed and drained. By a separate incision the abscess cavity over the appendix was opened, cleansed, and drained. A prolonged convalescence eventuated in complete recovery.

In cases of abscesses which are opened externally, the result of the operation is almost always favourable.

So far, therefore, as prognosis is affected by removal of the appendix, it may be briefly summed up by saying that appendicectomy is safest during the quiescent periods of relapsing cases, and at an early date in acute cases; that is to say, before the appendix has contracted adhesions, and before there is any exudation. It is doubtful in acute cases with supuration more or less advanced, while it is almost hopeless in general peritonitis.

**Treatment.**—Probably in no disease does greater divergence of opinion exist as to treatment than obtains in connection with appendicitis. Between the two extreme views of never to operate and always to operate there exists a mass of equally conflicting opinions, which renders it all but impossible to formulate any but the most general lines for guidance.

It must be remembered that the majority of cases recover, and the true object of operative intervention should be to save those which nature's efforts cannot, however much they may be assisted by medical treatment. The difficulty of course is to know whether these palliative efforts will prove ineffectual and when.

I am disposed to think that most surgeons in this country are not likely to operate or be called upon to operate within the first forty-eight hours of an ordinary acute case. I venture to think that were we in the position of the patient and not in that of the practitioner, we should certainly refuse the operation of appendicectomy at the outset. And, further, I believe that the consensus of opinion among surgeons on this side of the Atlantic is that operation should not be performed during the acute stage, excepting only on the sudden onset of untoward symptoms indicative of perforation, or the bursting of an abscess into the peritoneal cavity. This non-interference

in the earlier stages of the disease does not, however, remove the surgical responsibility which attaches to the case from its very commencement. The possibility that at any time urgent symptoms may call for immediate operation renders it imperative that these cases should from the first be under the charge of the surgeon and not the physician. In claiming a surgical supervision of these cases it is not meant that they necessarily require operative treatment, as is sometimes erroneously supposed and asserted, but that the surgeon's knowledge of the case from the first better prepares him for any contingency which may arise, and admits of that promptness of action which alone can prove the means in many cases of saving life.

If, then, only exceptional complications demand operation during the acute stage of the disease, what is to be said of those cases which become chronic or relapse? Should they be operated upon?

In the first place the operation of appendicectomy, when conducted in the quiescent stage of the disease and by competent operators, has been shown to be exceptionally safe. The question of weakening the abdominal parietes is but slight when proper attention is devoted to the primary incision. Cases of ventral hernia occasionally occur. Treves<sup>1</sup> computes them at about 5 per cent.

Should appendicectomy be performed in a case which has recurred once, or should it be delayed till after a second recurrence, or a third, and so on? Possibly the proper way to answer the question is to consider the condition of the patient after the attack: whether there is a return to complete health, or whether there is some lingering pain, tenderness, or sense of discomfort in the region of the appendix. In the former case it is possible that another attack will not be forthcoming; in the latter it is probable it will. Hence it would appear a reasonable indication for the operation when the patient seems to suffer from persistent mischief which, if it does not keep him continually more or less an invalid, at least subjects him to attacks which will be troublesome and may at any time prove dangerous.

A somewhat more difficult question to answer is the advisability or not of cutting down upon a fulness or tumour

<sup>1</sup> *Lancet*, 1896, vol. i. p. 16.



felt to exist in the iliac fossa. Assuming that it is large enough to indicate a collection of exudation, pus, or otherwise, should it be allowed to progress until there is unmistakable evidence of its proximity to the parietes before being opened; or should an endeavour be made to reach it and empty it before any such evidence exists? Here, again, I venture to think the consensus of opinion among surgeons in this country is in favour of delay rather than otherwise. That is to say, it is considered advisable to ensure the adhesion of the parietal peritoneum to the advancing abscess cavity before opening. The argument in favour of not delaying is the possibility of the abscess bursting into the peritoneal cavity. But the question is whether there is not greater danger of producing that result by the very measure which is adopted to prevent it. However, the skill of the operator is a not unimportant factor in forming a decision, for there is much to show that a careful deep dissection may be carried out with almost as much safety as if no such dissection were required. It must be remembered that in some of these cases of abscess formation the seat of suppuration is probably retroperitoneal, and that therefore there is less danger of the general peritoneal cavity being opened than where the abscess is intraperitoneal, its boundaries consisting of adhesions variable in extent and in strength.

If, then, operation be not deemed the proper expedient to adopt within the first forty-eight hours of an ordinary acute case, what treatment should be employed? Advice in this respect is almost as confusing as in the case of operation; fortunately, however divergent the opinions, no very great harm under any particular method can accrue.

Accepting only the opinion of those who from a long and large experience are alone competent advisers, the following lines in treatment may be laid down:

The patient is put to bed and kept as much as possible at rest. The pain in the iliac region may be relieved by the application of a soft linseed meal poultice of sufficient temperature to be comfortably borne. All applications likely to irritate the skin should be avoided. Much as poultices are distasteful to the surgeon, and in most cases justly so, there is nothing that proves so soothing in effect.

No solid food should be administered, but the patient's strength kept up by fluids, such as chicken broth, beef tea, whey, and suchlike. Milk, from the fact of its curdling in the stomach, and becoming thereby largely of the nature of a solid, should be avoided. This avoidance of milk is strongly advocated by Thornley Stoker.<sup>1</sup> The same writer deprecates the use of ice for thirst, but recommends frequent rinsing of the mouth with hot water, and swallowing occasionally a teaspoonful of warm water.

Whether opium in some shape or form should be given is a much disputed point. The majority, at least of surgeons, are against its employment. The chief disadvantage of its use is the likelihood of symptoms being masked, and so subsidence of the disease assumed, when in reality grave progress may be taking place. It is easy to write what should be done, but it is difficult when face to face with the sufferer to withhold the hand from what will certainly give relief. However, when opium is administered, if possible greater watchfulness should be exercised, in order to note the first indications of any untoward complication and to properly discount the influences produced by the drug.

Excluding cases where the onset is marked by undue severity, no treatment is fraught with better results than that which aims at relieving the bowels either by the administration of some saline aperient or the careful use of warm-water enemata.

As regards purgatives, Stoker orders two drachms of sulphate of soda to be given every hour until the bowels move. Fowler gives half-ounce doses of sulphate of magnesium dissolved in Vichy water; this is followed by drachm doses given hourly until the bowels act thoroughly.

In the employment of warm-water injections the best method to adopt is to introduce a soft tube well up the rectum, and allow the water to gravitate slowly into the bowel. This should be repeated several times, until it is found that the return of faecal material in the outflowing fluid indicates that some solvent or mechanical effect has been produced upon the contents of the probably loaded colon.

Movement of the bowels may be looked upon as one of the best indications of a favourable result.

<sup>1</sup> *Brit. Med. Journ.* 1895, vol. i. p. 1193.

## CHAPTER LXIII

APPENDICITIS (*continued*). OPERATION. OTHER DISEASES  
OF THE APPENDIX

**Operation.**—The excision of the appendix will be found described under ‘Appendicectomy’ in Chapter LXVIII; but it is necessary to indicate here in detail some of the numerous difficulties and complications which the surgeon may have to encounter in operation upon the part, whether or not the appendix is removed.

These considerations may be discussed under five heads: 1. Abscesses; 2. Fistulæ; 3. Adhesions without an exudation; 4. Adhesions with an exudation; 5. Perforation and peritonitis.

1. *Abscess.*—In cases where redness and œdema of the skin over the iliac region indicate the approach of pus to the surface, but little difficulty is encountered in reaching it. The skin incision, however, should not be larger than is requisite for the free evacuation of the abscess. A too free incision might carry the opening beyond the limits of the adherent peritoneum, and so endanger the general peritoneal cavity. Any digital examination of the abscess cavity must be most cautiously carried out, otherwise limiting adhesion may be inadvertently broken down and the general abdominal cavity opened into. Nor for the same reason should any violent irrigation of the cavity be exercised. Allis<sup>1</sup> records an instance of an abscess in the right iliac fossa which was opened. A surgeon who was standing by requested the privilege of passing his finger into the opening. This was granted, the finger was passed deeply into the cavity and swept freely round. A rapidly fatal general peritonitis followed. In most instances it will be quite sufficient simply to open the abscess at its most prominent point, put in a large-sized drainage tube, and so disturb the part as little as possible. When the abscess presents most prominently in the pelvis towards the rectum it should be opened there, as advocated and successfully carried out in three cases by Allis.<sup>1</sup> No attempt

<sup>1</sup> *Annals of Surgery*, 1896, vol. xxiii. p. 272.

should be made to remove the appendix, for it is running needless risk in a class of cases which more frequently than not recover permanently.

2. *Fistula*.—Fæcal fistulæ sometimes remain after the opening or bursting of an abscess either through the abdominal parietes or into the rectum or bladder. In the former case the fistula may be due to a fæcal concretion, the removal of which by forceps leads to rapid healing of the wound. Where no such source of irritation exists, the fistula in the majority of cases sooner or later closes. Its undue persistence may depend upon a perforated appendix, and in such cases nothing but careful dissection of the region, with removal of the organ, will effect a closure of the fistula.

Where a communication exists either with the rectum or the bladder, an operation to reach these parts will be necessary. It will probably be found to be due to a perforated appendix. Removal of this, with closure of the vesical or rectal aperture, will effect a cure. In a case recorded by Hector Cameron,<sup>1</sup> where a communication existed between the appendix and the bladder, the patient suffered from symptoms like those of cystitis, having to pass urine every half-hour. The abdomen was opened, and the appendix found attached by what ought to have been its free extremity to the bladder. It was ligatured and cut out, only the two ends being left at their points of attachment. The patient made a perfect, though somewhat tardy, recovery.

3. *Adhesions without exudation*.—Every degree of firmness may be found in the adhesions which bind the appendix to the surrounding parts. In the worst cases the intestines about the region of the appendix are so matted together that the bowel is more readily torn than the adhesions separated. In one of my own cases I was forced to excise two or three inches of the ileum. The patient, however, made a perfect and uninterrupted recovery. Treves<sup>2</sup> in two of his cases (Cases XI. and XII.) pared the appendix down until a small disc-shaped piece was alone left attached, in the one case to the bowel, and in the other to the bladder. Both cases recovered.

<sup>1</sup> *Trans. Path. and Clin. Soc. Glasgow*, 1895, vol. v. p. 123.

<sup>2</sup> *Brit. Med. Journ.* 1893, vol. i. p. 837.

4. *Adhesions with exudation.*—The presence of an exudation, purulent or otherwise, adds an additional complication to the existing adhesions. The danger in these cases is that infection of the peritoneum may be caused by breaking down adhesions which had served to limit and cut off the septic material from the general peritoneal cavity. If the cavity be comparatively small it may be thoroughly wiped dry after the removal of the appendix, and then freely dusted with iodoform. In one such case I closed the parietal wound after this treatment: the patient recovered without an untoward symptom. If, however, the cavity be larger and less limited, and a doubt remains in the surgeon's mind as to his having perfectly removed all septic matter, the cavity should be carefully stuffed with strips of iodoform gauze, so inserted as to be easily withdrawn in the course of forty-eight hours or so.

5. *Perforation and peritonitis.*—Treatment in these cases demands consideration not only of the seat of the disease, but also of the whole peritoneal cavity. While the former must be dealt with according to the conditions found, a free irrigation of the latter, or removal of the septic material or exudate by sponge cloths, is necessary. If it is found impossible, as it most likely will be, to deal effectually with the peritoneal cavity through the lateral incision, a median one must be made. The question whether it is wise to irrigate the peritoneal cavity in all cases is disputed by some surgeons. The main object in view is the removal of the septic material, and if this can be effected by gently wiping the parts, it is probably better than flushing them. In Lane's case, already referred to, the peritoneal cavity was not washed out, the wound was closed, the patient kept under morphine, and nourishment given *per rectum*. In two cases of recovery mentioned by Barker,<sup>1</sup> flushing was employed, no drainage tubes were introduced. In McBurney's successful case both copious irrigation and drainage were used. Demoulin<sup>2</sup> in his successful case drained only, and sponged away any exudate. The best guide to irrigation or non-irrigation is possibly to be found in the nature of the peritonitis. If this is of the adhesive character irrigation should not be practised; if on the other hand

<sup>1</sup> *Brit. Med. Journ.* 1894, vol. i. p. 355.

<sup>2</sup> *Archives Générales de Médecine*, 1894, vol. i. p. 712.

there is a quantity of purulent material, or fæcal extravasation, thorough washing out and drainage should be employed.

*After treatment of operation.*—This follows upon the general lines laid down for all operations upon the intestinal canal, with the only possible exception, however, of an early endeavour to get some action of the bowels. No symptoms are more favourable after operation than a fæcal evacuation; while obstinate constipation may prove the forerunner of general peritonitis. Should the latter symptom be accompanied with gradual rise both of pulse and temperature coupled with vomiting, the surgeon may have the gravest fears regarding the hopeful prospect of the case.

The aperients given are those already indicated, and they may be administered in the same quantity and with the same frequency (see page 512). Talamon<sup>1</sup> advocates either castor oil or calomel. The surgeon, however, will often be guided best by what the patient's stomach seems most readily to tolerate. It is wise to avoid violent purgation.

As regards diet, only small quantities of warm water should be given during the first twenty-four hours. After this a little peptonised milk can be administered, and a gradual increase in the quantity and strength of the food henceforth proceeded with.

Should symptoms of peritonitis become manifest, the usual measures must be adopted. Whether or not the surgeon feels justified in reopening the abdomen and cleansing the peritoneal cavity must be determined by the general condition of the patient. So far I have not come across the record of any case where such treatment has been followed with success.

**Other diseases of the appendix.**—With the exception of inflammation there are but few other diseases which affect primarily and exclusively the appendix. Tumours of both a malignant and innocent character are occasionally, though very rarely, met with. Stimson<sup>2</sup> records having removed an appendix in a state of cancerous degeneration. It was four inches in length and nearly an inch thick. The greatly thickened mucous membrane projected in the form of a ring

<sup>1</sup> *Appendicite et Péritiphylite*, 1892, p. 211.

<sup>2</sup> *Annals of Surgery*, 1896, vol. xxiii. p. 186.



PLATE XXV.



Fig. 64—CYSTIC VERMIFORM APPENDIX. (*V.I.M., Glas.*)



into the lumen of the cæcum. Kelynack,<sup>1</sup> as the result of a very searching inquiry, found only two references to primary disease of the part. One of these was Leichtenstern's report of three cases of cancer of the appendix, about which, however, from want of a full report, there remains doubt as to the primary origin of the disease; and the other, Draper's case of supposed colloid carcinoma. The appendix may of course become involved secondarily by extension from neighbouring parts, but in this the organ presents features in common with other regions of the intestinal canal.

In making the post mortem of a patient who had died of chronic Bright's disease, I<sup>2</sup> removed an appendix which had undergone cystic degeneration. The organ was quite normal for its proximal two inches, but the distal portion, measuring another two inches, was dilated into an egg-shaped tumour (see Plate XXV, fig. 64). On opening this latter, it was found to be distended with a clear gelatinous substance which could be turned out *en masse*, leaving a smooth, slightly sacculated wall. Coats<sup>3</sup> has reported and figured a similar condition, the only one he has met with in his extensive pathological experience. In the Royal Infirmary of Glasgow there is a remarkable specimen of apparently a similar disease. The appendix has been transformed into a bulky cyst. It measures five and a quarter inches in its long diameter, and one and a quarter to two inches in its short diameter. In shape it resembles an elongated cylinder, and was filled with a thick mucous material. The patient died of renal disease, and apparently had not during life any symptoms connected with the cystic appendix.<sup>4</sup>

The attention which has been directed to the appendix by pathologists in recent years may result in the organ being found diseased much more frequently than previously supposed. Lewis Sutherland, of the Western Infirmary, Glasgow, reports having met with two instances of cystic disease resembling those narrated above, while making post mortems.

<sup>1</sup> *Pathology of the Vermiform Appendix*, p. 139.

<sup>2</sup> *Trans. Path. and Clin. Soc. Glasgow*, 1892, vol. iv. p. 111.

<sup>3</sup> *Manual of Pathology*, 3rd edit. p. 876.

<sup>4</sup> *Museum Catalogue*, series vi. p. 92.

## CHAPTER LXIV

## OPERATIONS UPON THE SMALL AND LARGE INTESTINE

- |                        |                       |
|------------------------|-----------------------|
| I. ENTEROTOMY          | VII. COLOSTOMY        |
| II. ENTEROSTOMY        | VIII. COLECTOMY       |
| III. ENTERECTOMY       | IX. COLOPEXY          |
| IV. ENTERO-ENTEROSTOMY | X. ARTIFICIAL ANUS    |
| V. ENTEROPLASTY        | XI. APPENDICECTOMY    |
| VI. COLOTOMY           | XII. OTHER OPERATIONS |

OPERATIONS upon the bowel are numerous, but still more numerous are the methods employed in performing them. It is impossible within a comparatively limited space to do more than describe those operations, and the methods of executing them, which may be said to have attained to some degree of general recognition. Of many methods it may be truly said that they receive little more application than that exercised by the originator. An operation and its mode of execution in order to pass beyond the exclusive practice of its author, must in the first place possess all the elements of simplicity in its application, and in the second be certain in effecting the end required. Many an operation upon the bowel has to be performed at short notice, under unfavourable surroundings, with limited assistance, and often by not very experienced operators. Any method therefore which fails to give the surgeon the necessary requirements under all circumstances must be considered unsatisfactory, and cannot be expected to commend itself to more than a very limited circle.

Where various methods exist for performing one particular operation, and where the merits of one offer no very striking advantage over the merits of another, the surgeon would do well to select one, and be prepared to practise that efficiently when occasion requires. Unless the operator be one whose practice is large in the department of gastro-intestinal surgery, to try one method after another is only too likely to end in never succeeding with any.

In the list of operations which follow, I have endeavoured to simplify their description by adopting some sort of a classification. It is not easy, however, to prevent overlapping; nor

is it easy to assign a definition in certain cases where contemporary literature applies to a word more than one meaning. Thus the word 'colotomy' ought to be limited to merely incising the colon for the extraction of a foreign body &c., just in the same sense as the word 'gastroto-my' is used in regard to the stomach. It is, however, often applied to what should be more strictly termed 'colostomy.' It is frequently, too, used to express the formation of an artificial anus. Similarly 'enterotomy' is used for 'enterostomy,' the term signifying the establishment of a faecal fistula in cases of acute obstruction. As, however, we now have the term 'enterostomy' for this operation, 'enterotomy' should be limited to a similar usage as that of 'gastroto-my,' that is to say, the simple incision of the bowel, with its immediate suture. The word 'enterorrhaphy' lacks also in aptness and correctness of application. If it is to signify in the case of the bowel what it implies in the case of the stomach, it should mean the suturing together of a fold in the wall of a dilated intestine. It is, however, used to indicate suturing together the *cut* walls of the bowel. As nearly all operations involve more or less suturing of the edges of a bowel wound, the term becomes practically synonymous with the word 'suture,' and for simplicity of nomenclature it would be better to abandon it. Its ambiguity is further increased by the fact that it is sometimes used for methods of uniting the bowel other than those by suture. Another somewhat ambiguous word is 'colostomy.' Here, again, if it is to rank in similarity of explanation with 'gastrostomy' and 'œsophagostomy,' the term should signify strictly the stitching of the colon to the parietal wound, and the formation of an opening in the bowel; in other words, the production of a faecal fistula. It is, however, frequently used for the operation of producing an artificial anus, where the entire, and not the partial, contents of the bowel are allowed to escape externally.

The terms 'ileostomy,' 'colostomy,' and 'sigmoidostomy' are in one sense misnomers. Their extension in usage to the formation of faecal fistulæ is strangely out of keeping with the true meaning of the words. In the cases of the œsophagus, stomach, duodenum, and jejunum, the affix 'stomy' (*stoma*, a mouth) has a correct application; but considered from the same point of view, it becomes peculiarly inappropriate to

operations which have for their object, not the production of an orifice (mouth) of entrance, but one of exit (anus). The terms, however, have this advantage, that they signify operations which in all points of their performance are similar to those in which the affix has its strictly correct meaning from the functional aspect of the question.

Again, there is much confusion in the use of the terms intended to imply the junction or union of one part of the bowel to another. If the union of the stomach to the jejunum be termed 'gastro-jejunosomy,' then the union of the jejunum to the ileum should be 'jejuno-ileostomy;' of the ileum to the colon, 'ileo-colostomy.' It is not, however, infrequent to find the operation spoken of in the inverse way—thus, 'ileo-jejunosomy.' Further confusion exists in the fact that these terms are sometimes used for two totally distinct operations, as for instance the lateral approximations and fistulous connection between two coils of intestine; and the entire implantation of the transverse section of one portion of bowel into an orifice in the lateral wall of another.

If authors would use terms which have the same relative significance in the œsophagus, stomach, and intestines, where comparisons can be drawn, the whole nomenclature of the subject would be greatly simplified, and some degree of perspicuity would exist where at present there is often much confusion.

The following list may be taken to fairly represent the more or less recognised operations upon the small and large intestine—excluding those of the duodenum, which have already been given, and those of the rectum, which will be described later.

- |                  |   |                              |                          |  |
|------------------|---|------------------------------|--------------------------|--|
| I. Enterotomy    | { | a. Jejunotomy.               |                          |  |
|                  | { | b. Ileotomy.                 |                          |  |
| II. Enterostomy  | { | a. Jejunostomy.              |                          |  |
|                  | { | b. Ileostomy.                |                          |  |
| III. Enterectomy | { | a. Entero-anastomosis        | {                        |  |
|                  | { | b. Artificial anus (enteric) |                          | 1. End-to-end anastomosis.               |
|                  |   |                              |                          | 2. Lateral anastomosis or approximation. |
|                  |   |                              | 3. Lateral implantation. |  |



I. **Enterotomy.**—The operation is performed for the removal of obstructive agents, such as gall stones &c., from the interior of the small intestine. The terms *jejunotomy* and *ileotomy* imply that the operation is performed either upon the jejunum or the ileum.

*Operation.*—The abdomen is opened in the median line, usually below the umbilicus.

The loop of intestine containing the body to be removed is withdrawn from the abdomen, and carefully protected there with suitably disposed cloths to prevent any contamination of the abdominal cavity when the bowel is opened.

An assistant squeezes out of the intestinal loop with his thumb and forefinger such contents as can be so removed, and then clamps each portion of the bowel on the proximal and distal sides of the part to be opened, by constricting with the thumb and forefinger of each hand.

By an incision of requisite length the surgeon opens the intestinal canal in the long axis of the bowel, at the part of the wall most distant from the mesenteric attachment. The obstructing agent is extracted, any bleeding points secured, and the edges of the wound tucked in and united by a continuous Lembert suture. Care must be taken to see that the mucous membrane is well involuted. After cleansing the part, the loop is returned to the abdomen and the parietal wound closed.

The term ‘enterotomy’ has been applied to Nélaton’s operation, see below—enterostomy.

II. **Enterostomy.**—This operation is performed in the upper part of the small intestine—jejunostomy—for obstruction above, while it is performed in the lower part—ileostomy—for obstruction below. In the former case it is for the object of supplying nourishment to the patient, while in the latter it is to relieve the bowel of its obstructed fæcal contents.

The general term ‘enterostomy’ may be suitably applied to Nélaton’s operation, which is thus performed.

‘The seat of the operation is the iliac or inguinal region, preference being given to the right side. An incision is made through the abdominal parietes parallel to and a little above Poupart’s ligament and to the outer side of the epigastric artery. The skin incision is recommended to be about 7 cm. in

length. The deep incision whereby the peritoneum is opened being about 4 cm. in length. The first *distended* coil of bowel that presents itself is gently seized and drawn into the wound. If the operation be performed upon the right side it is found that the segment of intestine opened is nearly always the terminal part of the ileum. The gut is then fixed to the wound by a double line of sutures which transfix the intestinal walls. An opening is finally made into the bowel between the two lines of suture, and the operation is completed' (Treves).

**Jejunostomy.**—The operation is performed for extensive disease of the stomach, when gastro-enterostomy is not possible.

*Operation.*—An incision is made in the middle line, between the ensiform cartilage and the umbilicus. The index finger is inserted and a loop of the jejunum hooked up. To ensure that the portion of the bowel secured is the highest part that can be easily withdrawn, it should be traced upwards till the origin of the duodenum is recognised.

The bowel can then be stitched to the margin of the parietal wound, and left for four or five days to contract adhesions before being opened.

*Jessett's modification.*<sup>1</sup>—The required loop having been drawn through the abdominal wound, the author thus describes the further steps of his operation: 'I then pass a long straight needle armed with silkworm or chromic gut beneath the serous and muscular coats of the intestine in a longitudinal direction for from one to two inches, first on one side of the convex surface, then on the other; these two sutures run parallel to each other and are about an inch apart. I next pass two more sutures armed with needles across from the points where the longitudinal threads escape. I thus have a parallelogram enclosed between my four sutures; each of these is now passed through the abdominal parietes about half an inch on each side of its cut edge and through a decalcified bone plate with an opening in the centre' (as shown in figs. 22 and 23, see p. 237).

'The threads are next held in clamp forceps while the parietal wound is closed in the ordinary way. The threads

<sup>1</sup> *Surgical Diseases of the Stomach and Intestines*, p. 61.

are then tied firmly over the bone plates, first the lateral threads and then the end threads (as shown in fig. 22) ; and finally a portion of the intestine is drawn up through the opening in the bone plate and transfixed with a hare-lip pin which rests on the bone plate (fig. 23). The abdominal wound is closed by a couple of silkworm-gut sutures at each end. The wound is dressed in the ordinary way ; and on the fifth day, or earlier if necessary, a small opening is made with a tenotomy knife, and a winged gum-elastic catheter introduced and the patient fed by means of this.' This same method of operating is adopted by Jessett for gastrostomy.

*Maydl's modification.*<sup>1</sup>—An incision is made about 10 cm. long in the middle line, between the umbilicus and the ensiform cartilage.

The jejunum is sought for about 1 cm. from the plicoduodeno-jejunalis, emptied at this spot of its contents, and surrounded by two strips of iodoform gauze which are passed through the mesentery and tied. The bowel is then cut transversely across between the two strips. An incision about 3 cm. long is made in the convex side of the distal segment, and into this the orifice of the proximal segment is stitched (see fig. 65). The orifice of the distal segment is brought out at the abdominal wound, and secured there. This latter opening is reduced so as to form an orifice of only 2 cm. in breadth.

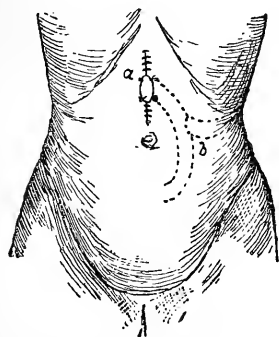

FIG. 65.—DIAGRAM OF MAYDL'S OPERATION OF JEJUNOSTOMY

*a*, orifice of jejunum stitched to parietal wound ; *b*, lateral implantation of upper segment into the side of the lower

The object of this operation, like that of Albert's which follows, is to procure a means of preventing the escape of the bile, pancreatic and gastric secretions through the intestinal orifice.

*Albert's modification.*<sup>2</sup>—The incision through the parietes is the same as that of Maydl.

A loop of jejunum is brought out through the parietal wound, which is for the greater part temporarily closed. At

<sup>1</sup> *Wiener med. Wochenschrift*, 1892, No. 20, p. 785.

<sup>2</sup> *Ibid.* 1894, No. 2, p. 57.



the base of the loop a lateral anastomosis is made between the proximal and distal parts.

Parallel to the first skin incision and 4 ctm. above it another incision is made, and a strip of skin 2 ctm. long raised. Beneath this the loop is passed and secured (see fig. 66) (as in Franks's method for gastrostomy). The lax portion of the loop with its anastomotic portion is now dropped into the abdominal cavity, and the first parietal wound closed. On the fourth day an opening is made by means of Paquelin's cautery into the loop, and nourishment administered.

**Ileostomy.**—This operation consists in opening the lowest part of the ileum for extensive obstructive disease in the region of the cæcum and ileo-cæcal valve.

The operation is thus described by Thomas Bryant,<sup>1</sup> who successfully employed it in a case.

'An incision about 2 or 2½ inches long was made in the direction of the right semilunar line, with its centre corresponding to a line drawn across the abdomen from one anterior superior spinous process of the ilium to the other.'

After the peritoneal cavity was opened 'the right index finger was introduced, which, having pushed aside the coil of intestine which presented itself, came down at once upon the cæcum.' With this guide the finger hooked up the ileum where it was about to join the cæcum. It was then stitched to the parietal peritoneum by sutures passing through the serous and muscular coats of the bowel. The angles of the wound were brought together by sutures, and two silk loops were introduced into the walls of the bowel to serve as guides to the second part of the operation. On the third day of the operation the intestine was opened by an incision about a quarter of an inch long, to be enlarged if necessary.

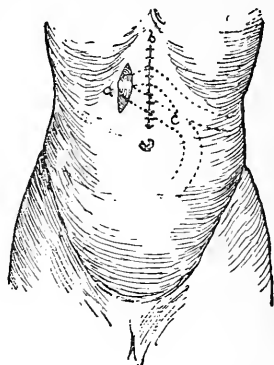

FIG. 66.—DIAGRAM OF ALBERT'S OPERATION OF JEJUNOSTOMY

*a*, apex of loop of jejunum drawn out beneath strip of skin between the first incision, *b*, and the second incision; *a*, first incision closed after making lateral anastomosis at *c* (jejunostomy) and returning the bowel into the abdomen

<sup>1</sup> *Lancet*, 1891, vol. i. p. 1.

## CHAPTER LXV

OPERATIONS (*continued*) : III. ENTERECTOMY

III. **Enterectomy.**—The operation implies excision of any part of the small intestine for tumour, disease, or injury. Except in the case of gangrene from strangulated hernia, the part of the bowel to be removed is withdrawn from the abdomen through an incision made in the median line either above or below the umbilicus.

*Operation.*—The involved loop of gut is retained by the hands of an assistant outside the parietal incision. The abdominal cavity is protected by properly disposed sponges or cloths.

The contents of that portion of the bowel which is to be included between the clamps is carefully squeezed out, and the intestine clamped at a convenient distance from each margin of the proposed line of section.

*Methods of clamping.*—Various instruments, complicated and simple, have been devised for preventing the escape of the fæces after excision of the segment.

A simple method is to pass pieces of indiarubber tubing through the mesentery at the required spots, and either knot them or secure them by means of pairs of forcipressure forceps (fig. 29, see p. 250).

Another equally simple method, and one which I am in the habit of making use of, is to slip pieces of indiarubber tubing over the blades of two pairs of ordinary dissecting forceps. One blade of each pair is thrust through the mesentery at the requisite spot, and then closed by slipping another piece of tubing over the approximated blades. The clamping can thus be rapidly performed, the bowel is not puckered as in the previous method, and the forceps can be prepared beforehand, and kept with the tubing in an antiseptic solution ready for use (see figs. 30–33, pp. 250, 251). Among special instruments, those by Makins, Lane, Treves, and Bishop may be mentioned. In those devised by the latter two surgeons, the clamps are connected by rods which admit of their being approximated when the requisite portion of bowel has been removed.

*Excision.*—The bowel being clamped, it is divided at a convenient distance from the clamps either by knife or scissors. The mesentery when reached may either be divided along the attachment to the bowel or a wedge-shaped piece excised. In both instances the vessels must be caught up with catch forceps and ligatured. The removal or not of a wedge-shaped piece of mesentery depends upon the length of the portion of bowel excised and the ultimate steps of the operation. For the completion of the operation one of two steps must be taken—either the continuity of the canal is to be re-established, or it is to be permanently or temporarily interrupted by the formation of an artificial anus.

**Entero-anastomosis** usually consists in the re-establishment of the continuity of the canal after the operation of enterectomy, or, better, it completes the performance of this

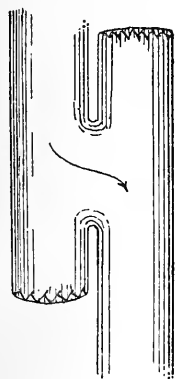

FIG. 68.—LATERAL ANASTOMOSIS OR APPROXIMATION



FIG. 67.—END-TO-END ANASTOMOSIS

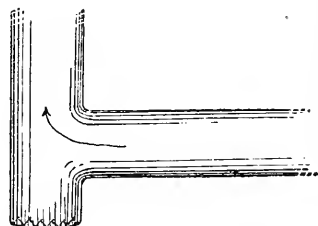

FIG. 69.—LATERAL IMPLANTATION

FIGS. 67-69.—DIAGRAMMATIC REPRESENTATION OF ENTERO-ANASTOMOSIS AFTER ENTERECTOMY

operation ; it is, however, also used to signify the union and communication of two segments of the gut without excision. There are three methods by which this end can be effected.

1. *End-to-end anastomosis.*—By this method the canal above becomes directly continuous with the canal below (fig. 67), the free edge of one transverse section of the bowel being united to the free edge of the other.

2. *Lateral anastomosis or approximation.*—By this method

the two ends of the divided bowel are placed side by side for a distance of some four, five, or more inches. The cut extremities are closed, but the continuity of the canal is established by lateral openings in the sides of the coapted bowel surfaces (fig. 68).

3. *Lateral implantation*.—By this method the transverse section of one end is closed, while the orifice of the other end is stitched with an opening made in the wall of the occluded segment (fig. 69).

Whichever of the above methods is selected, the next consideration is the way in which the union of the parts is to be effected.

**Methods of uniting bowel.**—Of all the departments of intestinal surgery none has exercised such an amount of ingenuity on the part of surgeons as that which concerns the efficient union of an orifice in one part of the bowel with an opening in another. Since the time of Jobert in 1822, but more particularly within recent years, 'new methods' of intestinal suturing have been constantly promulgated. How much real advance is being made by these later discoveries it is hardly possible to say; but one thing is certain, that many a so-called new method is very little more than a repetition or slight modification of an earlier one. I have myself seen a method proposed as new and original which had, on three earlier and different occasions, and by three separate surgeons also, been propounded as a 'new method.' Nothing short of a treatise itself would suffice to give the history and describe all the numerous methods of suture and union of bowel which have been projected within the last half-century. Many doubtless have been practised by none other than the originator. Some, however, have extended to a wider field of application; and it is only to these that I venture to draw attention. Doubtless I have failed to describe other methods as worthy and as useful as those here given, but I feel I shall quite sufficiently serve my purpose and that of the reader by not further lengthening my list.

A. *Union by suture*.—By this method is understood the union of the bowel surfaces without the aid of any mechanical contrivances, and only by thread, gut, silk, &c. Three ways of effecting this may be instanced.

1. *The circular*.—By this means the bowel orifices are end to end. It may be efficiently done by (a) the Czerny-

Lembert suture or this method modified by Wölfler, or (*b*) by Bishop's suture.

*a.* The Czerny-Lembert consists in passing two separate rows of interrupted sutures around the margin of the cut edges from without; while Wölfler's modification of the same consists in placing the first row ('Czernys') from within. Thus in the former method the inner row of stitches takes up

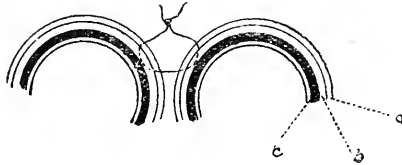

FIG. 70.—LEMBERT SUTURE

The stitches pass through the sero-muscular tunics of the bowel wall

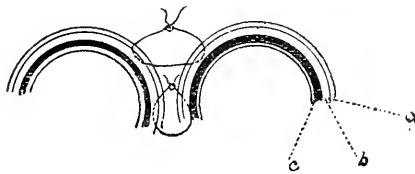

FIG. 71.—CZERNY-LEMBERT SUTURE

The first series of stitches pass through the edges of the sero muscular tunics and are tied externally. The second series are Lemberts

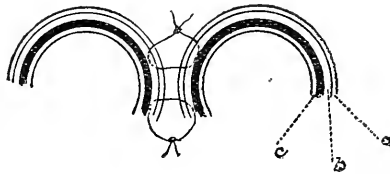

FIG. 72.—WÖLFLE'S MODIFICATION OF THE CZERNY-LEMBERT

The stitches are the same, with the exception that the first series are tied internally instead of externally.

FIGS. 70-72.—DIAGRAMMATIC REPRESENTATION OF UNION OF BOWEL ENDS BY CIRCULAR SUTURE

*a*, the serous coat ; *b*, the muscular coat ; *c*, the mucous membrane

and unites the free edges of the serous and muscular coats, the knots when tied lying without the canal (fig. 71) ; in the latter the same parts are secured, but the knots when tied lie

within the canal (fig. 72). In both methods an external row of interrupted Lembert stitches encircles the inner series. The mesentery is united well up to the bowel, and great care should be given to the coaptation of the mesenteric edges at their attachments to the bowel.

*b. Bishop's suture.*<sup>1</sup>—'The two divided ends of intestine being brought together so that their mesenteric borders lie in an exact plane, a fine round needle (No. 11), armed with a long double silk thread, is passed from the mucous surface of one, through the entire walls of both, to the mucous surface of the other. The needle, and with it the double thread, is drawn until about five inches of the thread are left on the side from which it has been passed. The needle is then again passed in the reversed direction at a distance of 2 or 3 mm. from the first puncture, and the threads drawn through until a double loop is left, having also a length of five inches (fig. 73). One of the loops is cut through, the other is

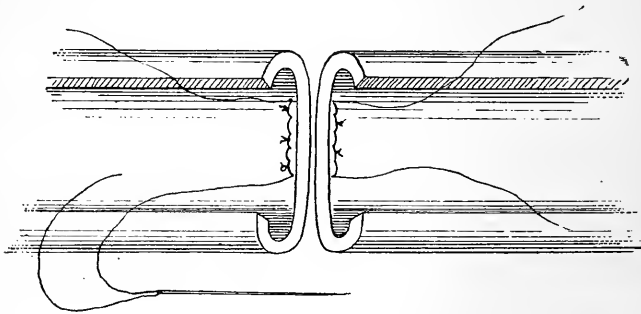

FIG. 73.—BISHOP'S SUTURE

drawn up and knotted with a reef-knot on the side started from. When the knot is made the ends are cut off close. Thus one loop has been formed uniting the two bowel walls by their serous surface. On the far side of the loop a long single thread is left, passing through the same opening as that passed through by the distal limb of the loop. (This thread is required later in finishing the last loop, and is useful all through the operation as a means whereby the bowel may be kept in position at the abdominal wound.) On the near side of the loop is another thread attached to the needle,

<sup>1</sup> *Trans. Med.-Chir. Soc. Lond.* 1887, vol. lxx. p. 347.

and also passing through the same opening as that which holds the near limb of the loop. Reversing the needle and carrying it again through the walls in the same direction as at first, another loop is made, which in its turn is knotted on the opposite side to the first knot; and by a repetition of the same acts a series of loops is formed all around the lumen of the intestine, each individual loop surrounding its own moiety of both walls passing through the same openings as its fellows on either side, but perfectly independent of them, lying transversely to the line of union and parallel to the plane of the intestine, not so tightly tied as at once to strangle the tissue enclosed, but certain, as it ulcerates out, to carry with it that portion of the valvular ring. The knots and nearly the whole of the loops are, moreover, inside the re-formed canal.'

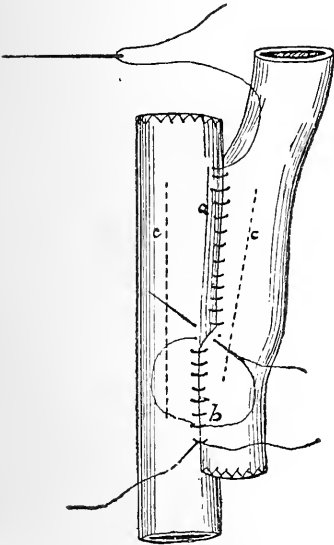

FIG. 74.—SUTURING INTESTINE IN APPOSITION BEFORE OPENING

*a*, first line of Lembert sutures; *b*, second parallel line of Lemberts; *c*, line of incision into bowel

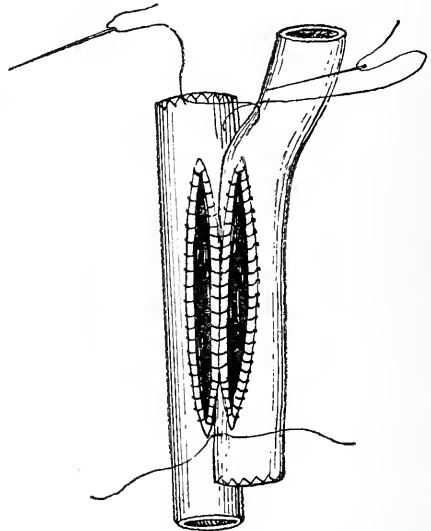

FIG. 75.—SUTURE OF EDGES OF OPENINGS PRIOR TO THE COMPLETION OF THE TWO LINES OF LEMBERTS

FIGS. 74 AND 75.—ABBE'S SUTURE

2. *Abbe's method of suture.*<sup>1</sup>—This method is intended for cases of lateral anastomosis where enterectomy has been

<sup>1</sup> *Medical Press and Circular*, 1892, vol. ii. p. 188.

performed. The open ends of the bowel are first closed by invagination of the serous surface and the insertion of a continuous Lembert suture. The lateral surfaces are then applied to each other so that about five inches of one extremity extends alongside the other for an equal distance. A continuous Lembert stitch is passed for nearly the entire length of the applied surfaces, and upon this and parallel to it a second continuous suture is passed (fig. 74). Both needles are left threaded at the end of the continuous series. The bowel is now opened by an incision four inches long, situated a quarter of an inch from the sutures. 'Another silk suture is now started at one corner of the openings, and unites by a quick overhand the two cut edges. The needle pierces both mucous and serous coats, and thus secures the bleeding vessels, from which the clamps (previously applied to stop hæmorrhage) are removed as the needle reaches them. This suturing is then continued round each free edge in turn (fig. 75), and all bleeding points are thus secured more quickly than by ligature. The serous surfaces around these button-holes are then rapidly secured by a continuation of the sutures first applied, the same threads being used, the one nearest the cut edge first. The united parts are again rinsed with water and dropped into the abdomen.'

3. *Maunsell's method of suturing.*<sup>1</sup>—This method is employed for end-to-end union after enterectomy. The portion of intestine having been removed, both ends of the bowel are brought together by two temporary sutures passed through all the coats of the intestine. The long ends of these sutures are left uncut. One suture is placed at the mesenteric attachment of the gut, and the other exactly opposite (fig. 76). The coats of the intestine are pinched up transversely (fig. 76, *b*), opposite to the mesenteric attachment, between the finger and the thumb, and divided with a tenotomy knife or a pair of scissors. This opening should be made about an inch from the severed end of the *larger* segment of bowel. Its length depends upon the size of the gut to be invaginated. The long ends of the two temporary ligatures are attached to a probe which is passed through the bowel and brought out at the

<sup>1</sup> Abstracted from the *International Journal of the Medical Sciences*, 1892, N.S. vol. ciii. p. 245.



incision (fig. 77). When pulled upon they invaginate the bowel and bring out the divided extremities at the incision (fig. 78). While an assistant holds the ends of the temporary sutures, the

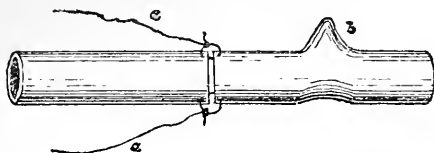

FIG. 76.

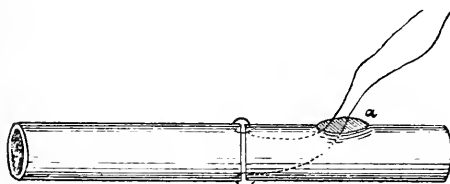

FIG. 77.

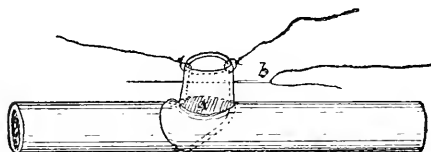

FIG. 78.

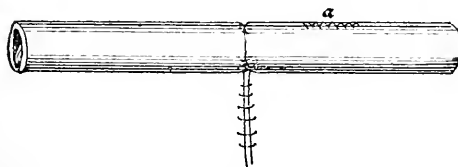

FIG. 79.

#### FIGS. 76-79.—MAUNSELL'S SUTURE

Fig. 76 shows the two segments united at the mesenteric and opposite borders of the gut by the two temporary sutures *a*; at *b* the bowel is pinched up transversely prior to opening by transfixion. Fig. 77 shows the two temporary stitches tucked in, and brought out at the newly made orifice *a*. Fig. 78.—The temporary stitches have been drawn upon, the bowel invaginated and brought out of the orifice *a*; the needle *b* is seen passing through both walls of the gut, carrying with it the thread for tying the margins.

Fig. 79 shows the operation completed. The orifice *a* is closed with a continuous Lembert suture, and two, three, or more sutures are inserted into the mesentery.

surgeon passes a long, *fine*, straight needle, armed with a stout horsehair or very fine silkworm gut, through both sides of the bowel, taking a good grip (quarter of an inch) of all the coats (fig. 78, *b*). The suture is then hooked up from the centre of

the invaginated gut, divided, and tied on both sides. In this way twenty sutures can be placed rapidly in position with ten passages of the needle. The temporary sutures are now cut off

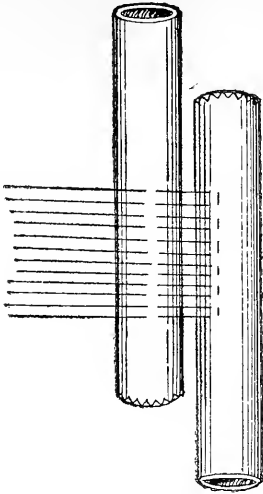

FIG. 80.—FIRST STAGE

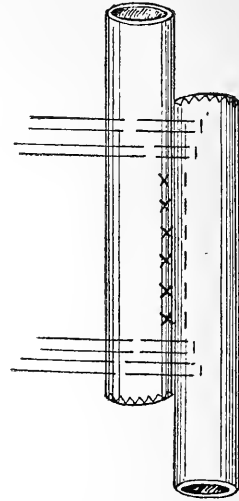

FIG. 81.—SECOND STAGE

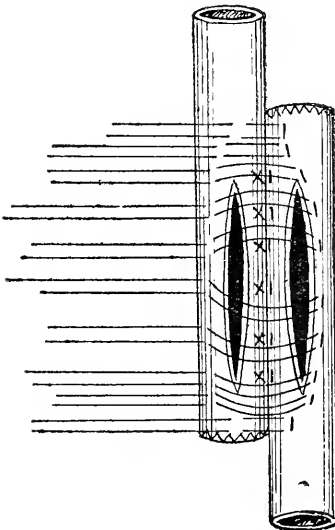

FIG. 82.—THIRD STAGE

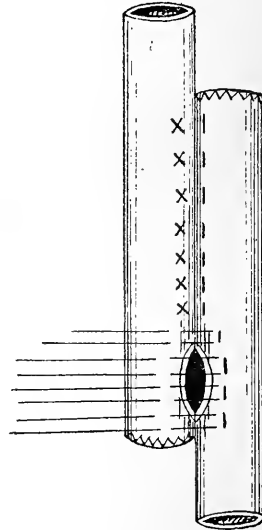

FIG. 83.—FOURTH STAGE

FIGS. 80-83.—HALSTED'S METHOD OF SUTURING

short, and the sutured ends of the bowel dusted with iodoform. The bowel is then pulled back. The longitudinal slit in the gut is well turned in and closed with a continuous suture (fig. 79) and redusted with iodoform. One or two sutures should be put in the mesentery.

This operation is also proposed for irreducible cases of intussusception. The longitudinal incision is used for the withdrawal of the intussusceptum and the proper union of the parts about the neck of the invagination. Quite similar methods for the radical treatment of intussusception have been devised by A. E. Barker, Jessett, and Bier respectively.

4. *Halsted's method of suture.*<sup>1</sup>—This method resembles Abbe's in being suited for lateral approximation. It differs, however, in the kind of suture used. After the two bowel surfaces are placed together, a series of interrupted quilt or square stitches are inserted (fig. 80). 'Six square or quilt stitches are taken in a straight row near the mesenteric borders of the selected portion of the intestine and tied. At each end of this posterior row of stitches, and nearer the convex border of the intestine, two lateral square stitches are applied (fig. 81) and tied; a little beyond the convex border the eight or nine square stitches which constitute the anterior row and complete the oval are applied, but not immediately tied. They are first drawn aside (fig. 82) to make room for the knife or scissors with which the intestines are then opened. Finally the sutures of the anterior row are tied' (fig. 83).

B. *Union by plates.*—Senn's method<sup>2</sup> with decalcified bone plates takes precedence of all others. These plates, when used in purely intestinal surgery, are suited best for lateral approximation.

For a description of the preparation of the plates, see p. 253 (gastro-enterostomy).

The method of threading the plates is best understood by a reference to the accompanying figures. Two fine sewing needles are threaded each with a piece of aseptic silk twenty-four inches in length; these are tied together as shown in fig. 84. By means of a fine hook a loop of the thread is

<sup>1</sup> From Jessett on *Surgical Diseases of the Stomach and Intestines*, p. 238.

<sup>2</sup> *Journal of the American Medical Sciences*, 1892, vol. xiv. p. 845.

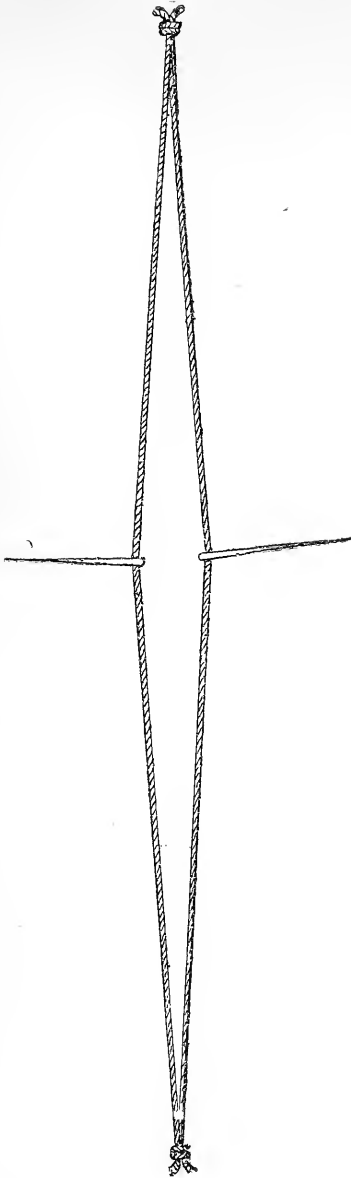

FIG. 84.

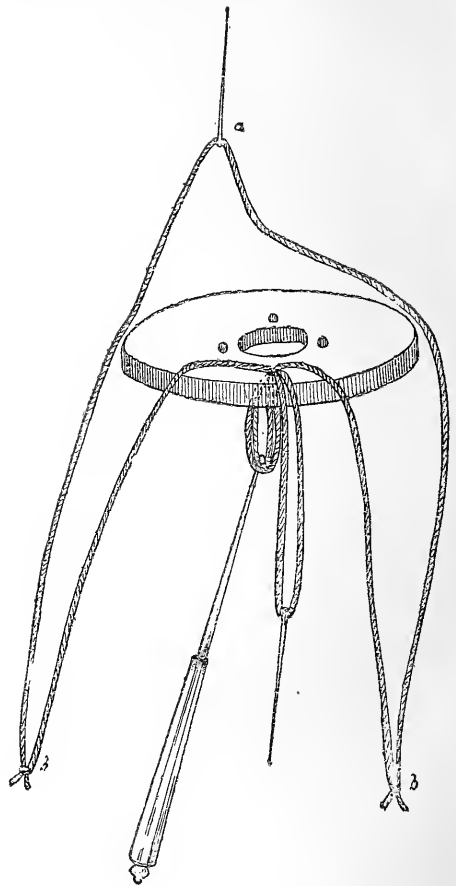

FIG. 85.

FIGS. 84 AND 85.—SENN'S METHOD OF THREADING DECALCIFIED BONE PLATES

Fig. 84 shows silk thread with needles attached, and knotted; fig. 85 shows first step in threading plate by means of hook

drawn through one of the perforations in the bone plate, as shown in fig. 85. A similar loop is in the same way drawn through each of the other perforations, and then a thread run through each of these double loops, and secured as shown in fig. 86. When the knotted ends and the needles are drawn taut the plate is ready for use, as shown in fig. 84 (see p. 254).

Littlewood<sup>1</sup> suggests the following modification of Senn's plates. A tube of decalcified bone is fixed into the aperture of one of the plates, and made to accurately fit into the aper-

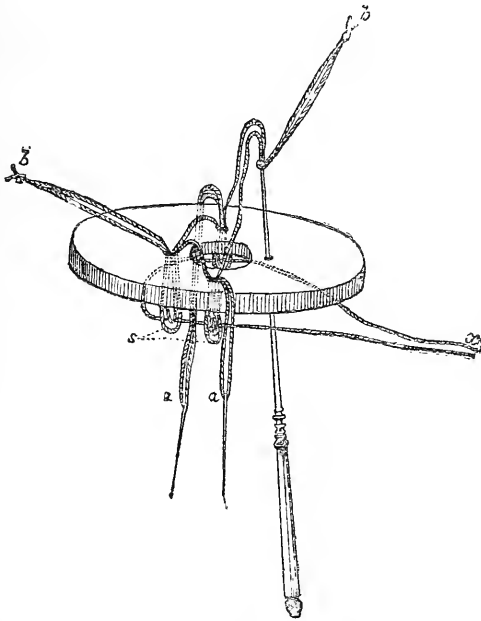

FIG. 86.—SENN'S METHOD OF THREADING DECALCIFIED BONE PLATES

Fig. 86 shows loops drawn through the perforations, and thread passed through the loops

ture of the other. By this method the two plates are held together, and the two parts of the intestinal wall between them brought evenly into contact with each other.

When a portion of bowel has been excised, the two open extremities are invaginated and closed by a continuous Lembert suture. As in the case of Abbe's method, the two

<sup>1</sup> *Lancet*, 1892, vol. i. p. 865.

segments are placed side by side; and to give extra security after the plates are inserted and tied, a continuous suture (fig. 87, *a*) is run between the two surfaces. The openings in the apposed surfaces of the bowel are then made, and the

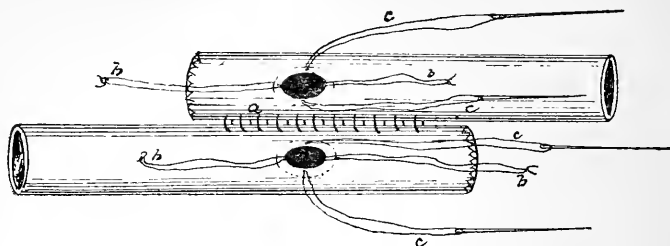

FIG. 87.—SENN'S METHOD OF LATERAL ANASTOMOSIS

Fig. 87 shows two portions of bowel united together by a continuous Lembert suture *a*. The plates have been inserted through the lateral longitudinal incisions; the knotted ends *b* are seen passing out at the extremities of the intestinal orifices while the lateral sutures *c*, with needles attached, are passing through the margins of the bowel wall

plates inserted. The assistant then approximates the two openings while the surgeon ties first the lower lateral threads, second the end ones, and lastly the upper lateral.

Plates made of raw hide have been used by Robinson,<sup>1</sup> and potato plates by Dawbarn.<sup>2</sup>

*C. Union by tubes.*—This method is employed for end-to-end union, and its object is to effect an easier and more exact coaptation of the bowel margins, as well as to maintain a patent and free channel between the two segments. Tubes of various materials have been used, but those which have met with most favour are made either of decalcified bone or of indiarubber.

*Paul's method with decalcified bone tubes.*<sup>3</sup>—After removal of the piece of bowel, the bone tube (fig. 88) is inserted into the upper end and sewn with a fine suture, great care being taken to attach the mesenteric border securely. Next the traction thread is passed through the wall of the lower segment (fig. 89), the cut ends of the bowel sewn together with another fine suture, and the wound in the mesentery united. The assistant then firmly holds the traction thread while the

<sup>1</sup> *New York Med. Journ.* 1890, vol. lii. p. 429.

<sup>2</sup> *Annals of Surgery*, 1893, vol. xvii. p. 147.

<sup>3</sup> Abstracted from the *Liverpool Med.-Chir. Journ.* 1892, vol. xii. p. 477.

surgeon invaginates the bowel for about half an inch, fixing it in this position with four small Lembert sutures (fig. 90). The traction thread is drawn tight, cut off short, and the ends allowed to drop into the bowel. 'When invaginating,



FIG. 88.

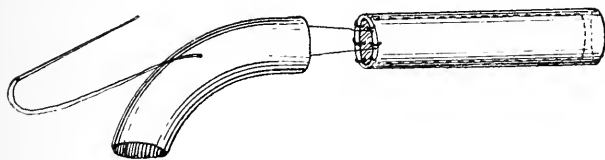

FIG. 89.



FIG. 90.

#### FIGS. 88-90.—PAUL'S METHOD OF SUTURE WITH BONE TUBES

Fig. 88 shows the decalcified bone tube threaded and with needle attached; fig. 89 shows the tube stitched in the bowel and the traction threads passed through the loop to be approximated; fig. 90 shows the operation completed, with a few interrupted Lembert sutures inserted at the external line of union.

an error must be guarded against. The invagination is most easily produced by allowing it to commence about half an inch or so below the tube. This means that the cut end will be barely covered by it, whilst the lumen of the bowel will be considerably blocked and the operation consequently most imperfectly performed. It must be made to commence *immediately* below the tube by drawing the very first part of the lower segment upwards with the tips of the fingers, and care must be exercised to observe that the mesenteric side of the bowel is as thoroughly covered by the invagination as the other side.'

*Robinson's method with indiarubber tube.*<sup>1</sup>—A rubber tube of from three to six inches in length and of suitable calibre is stitched into the proximal segment. The serous surface of the segment is scarified for an inch from the cut edge. The

<sup>1</sup> *Annals of Surgery*, 1891, vol. xiii. p. 86.

mucous membrane of the distal segment is dissected off for half an inch with a curved pair of scissors, and the freshened surface well curetted, so that all the intestinal glands are destroyed. The proximal segment is then pushed into the distal bowel lumen 'as one joint of stove-pipe is pushed into another,' and the distal drawn over and sutured in position. The sutures are passed completely through the

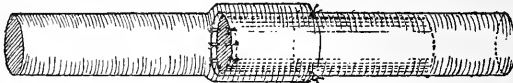

FIG. 91.—ROBINSON'S METHOD OF SUTURE WITH INDIARUBBER TUBE

circumferential margin of the distal bowel, and through the peritoneum and muscular coat of the proximal segment. Jessett has modified the method by using in place of rubber tubes, decalcified bone tubes.

The method is unsuited for cases where much disparity of size exists between the two segments.

D. *Union by decalcified bone bobbins.*—This method, proposed by Mayo Robson,<sup>1</sup> is for either end-to-end union or lateral approximation.

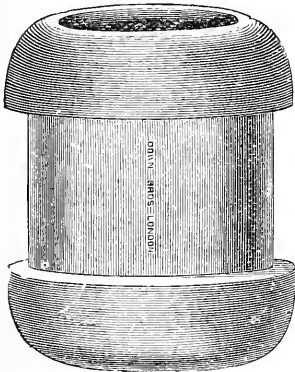

FIG. 92.—ROBSON'S DECALCIFIED BONE BOBBIN. (Full size)

The author in his earlier operations used two continuous sutures, a marginal and a serous. More recently he has not 'hesitated to employ one continuous stitch to unite the whole thickness of the gut where time was an object in the case.' In employing a single suture for end-to-end union, a silk thread eighteen inches in length is threaded upon a curved sewing needle; the posterior margins of the two visceral

openings (in cases of enterectomy) are united from right to left, the suture including mucous membrane, the tail of the suture being left long on the right side and kept threaded on the left. The bobbin (fig. 92) is now inserted, one end being in each segment of the bowel. The suture is then proceeded

<sup>1</sup> *Brit. Med. Journ.* 1893, vol. i. p. 689; also 1895, vol. ii. p. 963.



with around the front until the tail of the suture is reached. The two ends are then drawn tight, tied, and cut off short, and the operation completed.

When a second continuous suture is used in cases of lateral approximation this constitutes the serous suture, and is applied about half an inch from the place where the viscera are to be opened. The posterior is passed between the contiguous serous surfaces first, both ends being left long, so that after the viscera are opened and the bobbin inserted, the suture can be continued around. When drawn tight it completely shuts in the marginal or mucous suture.

The bobbin shown in the figure is the second largest in size. Three other smaller sizes are in use.

E. *Union by metal buttons.*—By this method either end-to-end or lateral union can be effected. It owes its origin to Murphy,<sup>1</sup> by whose name the buttons are generally known.

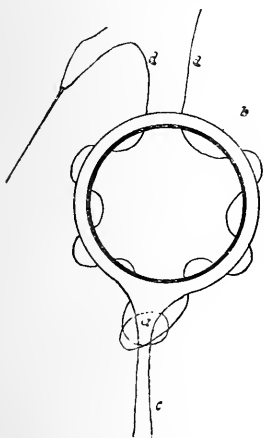

FIG. 93.

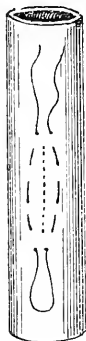

FIG. 94.



FIG. 95.

FIGS. 93-95.—MURPHY'S METHOD OF UNION WITH METAL BUTTON

Fig. 93 shows manner of inserting thread in end-to-end union: *a*, double turn of the thread through the mesentery; *b*, peritoneum; *c*, mesentery; *d*, ends of thread. Figs. 94 and 95 show running thread before and after incision of bowel in lateral anastomosis

Four sizes of these buttons are in use—No. 1, which is  $\frac{3}{4}$  inch in diameter; No. 2,  $\frac{1}{16}$  inch; No. 3,  $\frac{1}{16}$  inch; and No. 4, 1 inch. End-to-end, side-to-side, and end-to-side of the small intestine should be made with button No. 3. End-to-end and side-to-

<sup>1</sup> *Lancet*, 1895, vol. i. p. 1042.

side of the large intestine should be made with No. 4. (See figs. 35 and 36, p. 256.)

In effecting end-to-end union the suture is made to pass around the cut margin of each end of the bowel, as shown in fig. 93. The double turn through the mesentery tends to ensure efficient occlusion of that part of the coapted bowel margins. The two halves of the button are then inserted, and the 'puckering-string' is drawn tight. The union is completed by pressing the two portions of the button together. Care must be taken to include the free edges of the bowel between the two halves. The compressed tissue sloughs and comes away with the button, and an opening as large as the button remains.

In effecting lateral union much the same process is gone through. After the 'puckering-string' has been passed (fig. 94) and incisions of sufficient length made in the long axis of the bowel, one half of the button is placed in each viscus, the string drawn up and fastened, and the halves of the button pressed together.

'When returning the bowels to the abdomen, they should be placed in parallel lines, especially at the seat of approximation, to prevent sharp curves and obstruction.'

F. *Union by rings*.—This method is intended for end-to-end union. Rings made of catgut have been used by Abbe; and segmented rubber rings have been proposed by Brokaw. Both these kinds of rings have already been described in the operation of gastro-enterostomy, and need not therefore be further referred to here. (See p. 256.)

G. *Other methods of union*.—Various forms of clamps have been invented with the object of holding the parts in apposition until union has been effected. One of these, devised by Morison,<sup>1</sup> has fixed to one blade a tube which, when the clamp is inserted and the bowel tied around, admits of the escape of fæces. Another, introduced by Grant,<sup>2</sup> carries between the two clamping blades a knife, by which it is possible to make an incision through the coapted surfaces.

As lending some assistance to the surgeon to make a

<sup>1</sup> *Brit. Med. Journ.* 1893, vol. ii. p. 1047.

<sup>2</sup> *Annals of Surgery*, 1896, vol. xxiii. p. 38.

selection from these various methods, Edmunds and Ballance<sup>1</sup> reported to the Medico-Chirurgical Society of London the results of numerous experiments upon dogs to ascertain the best method of uniting bowel to bowel or bowel to stomach. In the case of the intestine, they found that for lateral anastomosis Halsted's operation was best; and for end-to-end union Maunsell's operation was the best, when conditions would admit of its performance.

---

## CHAPTER LXVI

OPERATIONS (*continued*): IV. ENTERO-ENTEROSTOMY; V. ENTERO-PLASTY; VI. COLOTOMY; VII. COLOSTOMY; VIII. COLECTOMY; IX. COLOPEXY

IV. **Entero-enterostomy (short-circuiting).**—This operation is performed when it is impossible to remove the diseased portion of the bowel. It consists in the lateral approximation of two segments and the formation of a fistulous communication. When the operation consists in uniting one portion of the jejunum to another, it is called 'jejuno-jejunostomy;' when the jejunum to the ileum, it is called 'jejuno-ileostomy;' when one part of the ileum to another, 'ileo-ileostomy;' and when the ileum to the colon, 'ileo-colostomy.' These same terms are frequently applied for what has already been described as lateral implantation; but when so employed, the homology is lost between these operations and gastro-enterostomy. To effect this method of anastomosis, either sutures such as Abbe's may be employed, or some of the mechanical methods by 'plates,' 'buttons,' or 'bobbins.' Reference to these methods, given above, will sufficiently indicate the mode of operation in cases suited for entero-enterostomy.

V. **Enteroplasty.**—This operation is for the treatment of simple stricture of the small intestine, and is intended to be adopted in place of enterectomy for these cases. The operation resembles in every respect that of the Heineke-Mikulicz operation of pyloroplasty (see p. 265). It appears to have been first successfully employed by Péan,<sup>2</sup> who adopted the

<sup>1</sup> *Brit. Med. Journ.* 1896, vol. i. p. 1200.

<sup>2</sup> *Bulletin de l'Académie de Médecine*, 1890, p. 856.

method for a stricture of the ileo-cæcal valve. It has more recently been practised by Allingham.<sup>1</sup> The operation consists in dividing the stricture, and then uniting the edges of the wound transversely, so that the centre of the incision comes to be at the ends.

**VI. Colotomy.**—This operation, like that of enterotomy, gastrotomy, and œsophagotomy, consists in an incision into the canal for the extraction of any foreign or obstructing material and the immediate closure of the wound.

The incision is made into any part of the large intestine, immediately over the seat of the object. The incision is in the long axis of the bowel, and at its convex border—that is to say, equidistant on each side from the mesentery. After removal of the object, the wound is closed by a continuous Lembert suture, due care being exercised to properly involute the cut margins.

The term ‘colotomy’ was always and is now frequently used for the operation which is often and much more appropriately designated ‘colostomy.’

**VII. Colostomy.**—The object of this operation is to form a fæcal fistula in the large bowel, although the practical result may, in some cases, be an artificial anus. When made in the lumbar region, it constitutes, according to the side, a right or left lumbar colostomy; when in the inguinal region, an inguinal or iliac colostomy; and when the sigmoid flexure is opened, sigmoidostomy.

The operation is usually performed for some obstruction below, either in the colon or in the rectum; and also in certain diseases of the colon and rectum, where it is desirable to irrigate and medicate the segment of the bowel below the artificial orifice.

**Lumbar colostomy.**—When performed in the right loin, this operation is known as Amussat’s, and the skin incision is transverse; when in the left loin, it is called Callisen’s, and the skin incision is vertical. Bryant, who is one of the strongest advocates for this operation, prefers an oblique incision in whichever loin the bowel is to be opened. The steps of the operation are thus described by this surgeon: <sup>2</sup>

<sup>1</sup> *Lancet*, 1891, vol. i. p. 1551.

<sup>2</sup> *The Practice of Surgery*, 2nd edit. vol. i. p. 633.

‘ The operation can be performed as follows, on the left loin: The patient is to be placed on his right side with a pillow beneath the loin, in order to arch somewhat the left flank, and turned two-thirds over on his face; the outer border of the quadratus lumborum muscle can then be made out, as this muscle is the surgeon’s main guide. Its outer border with the descending colon is to be found half an inch posterior to the centre of the crest of the ilium, the centre being the point midway between the anterior superior and posterior superior spinous processes. . . . An incision is then to be made four or five inches long, beginning an inch and a half to the left of the spine below the last rib, and passing downwards and forwards parallel with the crest of the ilium; the line of the incision should pass obliquely across the external border of the quadratus lumborum muscle about its centre, so as to take the same direction as the nerves which traverse this part. By this incision the integuments and muscles and fascia are divided, and the outer border of the quadratus muscle exposed. The abdominal muscles can be divided to give room, and this had better be done upon a director. All vessels are now to be secured. The transversalis fascia will next come into view, and beneath this will be the colon, a layer of fat sometimes intervening. The fascia is to be opened with caution, for in the loose fat and cellular tissue the colon is to be found; when distended, the bowel comes at once under the eye on dividing the fascia, but when empty some little trouble may be experienced in hooking it up with the finger. It can always be found in front of the lower border of the kidney. This organ should consequently be sought, as it is the only certain guide to the bowel. . . . When the bowel has been caught, it should be partially rolled forward in order to expose its posterior surface, for if this be not done, there is a risk of the surgeon wounding the peritoneum where it is reflected from its anterior surface on to the abdominal wall.

‘ The bowel having been drawn up to the wound is then to be secured to the integument and not to the muscles, by the passage of a ligature introduced through one margin of the wound, then through the bowel, and lastly through the other margin. The bowel can then be opened by a longitudinal incision about three-quarters of an inch long over the

ligature that has traversed its canal ; the centre of the ligature is then to be drawn out and divided, the two halves of the ligature fixing the two sides of the divided intestine firmly to the margins of the wound ; and two or four more stitches may then be introduced to make the artificial anus secure.'

**Inguinal colostomy. Sigmoidostomy.**—To open the colon in either the right or left inguinal region, an incision from two to three inches in length is commenced just external to the line of the deep epigastric (marked by a line drawn from the femoral artery to the umbilicus), and upwards and outwards, parallel to Poupart's ligament and about an inch or an inch and a half above it.

After opening the peritoneal cavity, the forefinger is inserted to bring up the colon to the wound. That the bowel thus secured is the large intestine, is known by the presence of longitudinal bands and appendices epiploicæ, and by its sacculated appearance. To maintain the bowel in position while it is being stitched, two temporary traction sutures may be inserted, one towards each end ; these pass through all the coats, and can be left in as guides for the subsequent opening of the gut. By a continuous suture, or several interrupted ones, the margins of the parietal wound are stitched to the sero-muscular coat of the bowel. If there is no urgency in the case nothing further is done, and the wound is left for four or five days, in order to get a firm union between the bowel and the parietes. An opening is then made with scissors or a knife, the two traction strings being pulled upon to act as guides for the line of the incision.

In this operation no attempt is made to form a 'spur,' nor to check in any way the passage of fæcal matter from the part of the canal above the opening into that below it. This latter object, when required, is effected by the formation of an artificial anus, and differs from any form of colostomy which merely seeks to establish a fæcal fistula.

**VIII. Colectomy.**—This operation implies the excision of some portion of the large intestine for disease or injury. When the cæcum is removed the operation is termed 'cæcectomy,' and when it is the sigmoid flexure it is called 'sigmoidectomy.'

*Operation.*—The skin incision is made according to the

supposed seat of the disease; when located in the more frequent localities, as the cæcum or the sigmoid flexure, the incision through the parietes is the same as that given above for inguinal colostomy: when in the ascending or descending colon, along the outer border of the rectus muscle: and when in the transverse colon, in the median line above the umbilicus.

After opening the peritoneal cavity sufficiently freely to admit of the affected portion being well drawn out of the parietal wound, the bowel is clamped and the operation proceeded with in the same way as has already been described in the case of the operation of enterectomy. (See p. 527.)

The next stage, after removal of the affected portion, consists in one of two procedures—either some form of union is effected, with re-establishment of the continuity of the canal, or an artificial anus is formed. If it is proposed to unite the ends of the bowel, then one of the methods already described must be adopted. As a practical guide to the surgeon in deciding what course he should pursue, the following advice given by Paul may be repeated here. ‘When the patient is in good condition, the abdomen not distended, the tumour small, and the proximal end of the bowel not greatly hypertrophied, immediate approximation by Murphy’s button may be attempted. But when the opposite of these conditions prevails, the ends of the bowel should be brought out.’

Although Paul specially advocates the use of Murphy’s button, success has followed the employment of suture, Robson’s bobbins, and some of the other mechanical measures. In cases where it is deemed advisable to make an artificial anus the following method of performing colectomy, as advocated by Paul, may be employed:

*Paul’s operation.*<sup>1</sup>—‘Make a sufficiently free incision over the site of the tumour. Having cleared away any adhesions, ligature the mesentery with the help of an aneurysm needle, and divide it sufficiently to free the bowel well beyond the growth on each side. Let the loop of bowel containing the growth or stricture hang out of the abdomen, and sew together the mesentery and the adjacent sides of the two ends’ (as shown in fig. 96). ‘The stump of the mesentery lies beneath

<sup>1</sup> *Brit. Med. Journ.* 1895, vol. i. p. 1139.

the bowel, where, if deemed advisable, it can be drained by packing antiseptic gauze down to it. Ligature tightly a glass intestinal drainage tube into the bowel above and below the tumour, and then cut away the affected part. Do not cut off first, or blood will be unnecessarily lost. Only the proximal tube is really necessary. The distal end may be closed or included in the proximal ligature. Close the ends

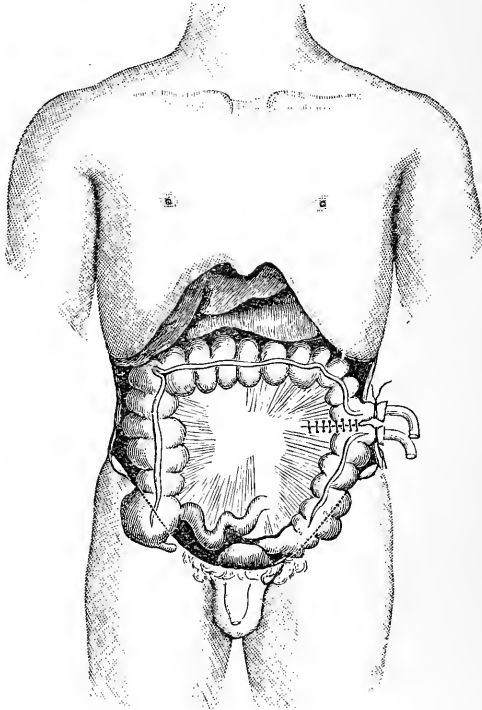

FIG. 96.—PAUL'S METHOD OF PERFORMING COLECTOMY  
Preparation of the bowel for the subsequent safe removal of the spur

of the wound with a few silkworm-gut sutures, passing through all the layers of the abdominal wall; no others are necessary. . . . The second stage of the operation, that of breaking down the spur with an enterotome, should generally be undertaken about three weeks later. As soon as this has been satisfactorily accomplished the artificial anus is closed by separating the rosette of mucous membrane from the skin,



turning it in, and bringing the freshened edges of the latter together over it.'

Another method of performing colectomy is to retain the coil of intestine with its affected area outside the parietal wound until adhesions have sufficiently shut off the peritoneal cavity, and then excise. When the obstruction caused is acute, an opening is made into the bowel above the seat of obstruction, and so relief afforded by the formation of an artificial anus. This method of operating is strongly advocated by Greig Smith<sup>1</sup> and by Harrison Cripps.<sup>1</sup>

An operation for which there exists no special name, but

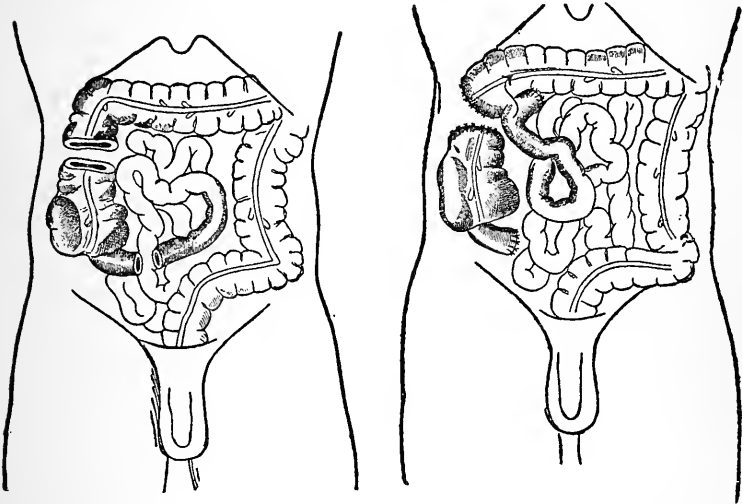

FIG. 97.—IRREDUCIBLE CHRONIC ILEO-CÆCAL INTUSSUSCEPTION. BEFORE OPERATION

FIG. 98.—IRREDUCIBLE CHRONIC ILEO-CÆCAL INTUSSUSCEPTION. AFTER OPERATION

FIGS. 97 AND 98.—SHORT-CIRCUITING WITH OCCLUSION OF A PORTION OF THE INTESTINE. (Baracz)

which somewhat nearly approaches enterectomy, has been successfully practised by Baracz.<sup>2</sup> It consists in severing the continuity of the canal in cases where the diseased segment cannot be removed, and uniting together the unobstructed segments thus freed. The operation will be best understood by reference to the accompanying diagrams. The complete

<sup>1</sup> *Brit. Med. Journ.* 1895, vol. ii. p. 965.

<sup>2</sup> *Centralblatt für Chirurgie*, 1894, No. 27, p. 617.

occlusion of a portion of the intestinal tract does not appear to be fraught with any untoward results. In a case reported by Obalinski,<sup>1</sup> a portion of the ascending colon was occluded. The patient, a female aged 24, was discharged at the end of the second month. The stools were normal and regular, and the patient quite well.

**IX. Colopexy.**—This operation consists in opening the abdomen, and fixing some part of the colon by suture to the parietal peritoneum. It has been performed for prolapse of the rectum; and to prevent the re-formation of volvulus after operation for untwisting the loop.

---

## CHAPTER LXVII

### OPERATIONS (*continued*): X. ARTIFICIAL ANUS

**X. Artificial anus.**—By the formation of an artificial anus is understood an opening into any part of the small or large intestine which entails the necessary escape of *all* the contents of the bowel above; thus differing from those operations in which only a portion may be ejected.

The anus receives its name from the particular part of the bowel of which it forms the termination; in the case of the small intestine it is an enteric anus; and in the case of the large, a cæcal; an ascending, a transverse, or descending, colonic; and a sigmoid, according to the anatomical segment implicated.

The operation is performed for all kinds of obstruction, whether acute or chronic, and the most frequent seat for its performance is the left inguinal region. The operation is frequently termed either ‘inguinal colotomy’ or ‘inguinal colostomy.’ With equal inappropriateness has the term ‘sigmoidostomy’ been used.

**Sigmoid anus.**—An artificial anus in the sigmoid flexure is most frequently made for obstructive disease in the rectum or lower part of the sigmoid flexure.

*Operation.*—The skin incision and the first steps of the operation to secure the sigmoid flexure are the same as those

<sup>1</sup> *Centralblatt für Chirurgie*, 1894, No. 49, p. 1193.

for the operation of sigmoidostomy (see page 546). When the loop has been withdrawn from the parietal wound it is to be secured in position, and so maintained until firm union is established between the layers of the visceral and parietal peritoneum. At the end of the fourth or fifth day this has taken place, and the operation is then completed by opening the bowel, and thus forming the anus.

Such is briefly the operation. There are, however, several details which need attention, and the carrying out of these has called forth many methods of operating. These various details may be thus enumerated: (1) Difficulty in finding the bowel; (2) whether the loop is twisted; (3) fixation of the bowel; (4) prevention of prolapse; (5) prevention of involuntary evacuations; (6) subsequent contraction of the orifice.

(1) *Difficulty in finding the bowel.*—Cripps adopts the following plan: 'If the bowel does not immediately present itself, it is best found by passing the forefinger deeply into the abdomen, and feeling for the brim of the pelvis, and by sweeping the finger along the brim the upper part of the rectum can be felt passing over it, and by keeping the finger in contact with this, it will guide the operator to the sigmoid flexure.'

(2) *The twisting of the loop.*—To determine whether the upper part of the loop is the proximal segment, pass the finger along the bowel surface into the abdomen, and note whether the gut then courses upwards or downwards; if upwards there is no twist.

(3) *Fixation of the bowel.*—If the mesentery is long enough to admit of the loop being withdrawn, its return into the abdomen may be prevented in several ways. I know of no simpler or more rapid plan than that of transfixing the mesentery immediately below the bowel wall with a small glass rod, which when passed rests on the skin of the abdominal parietes on each side of the wound. This method of transfixing the mesentery was first introduced by Maydl, who used a hard rubber cylinder covered with iodoform gauze. Since then, other similar modifications have been introduced. Kelsey<sup>1</sup> passes a hare-lip pin, first through the edge of the wound at its middle, then through the mesentery

<sup>1</sup> *New York Medical Record*, 1889, vol. xxxvi. p. 395.

close to the bowel, at the junction of the lower and middle third of the exposed loop, and lastly through the edge of the wound on the opposite side. Fixation may also be effected simply by suturing. Thus Lauenstein<sup>1</sup> passes sutures through the mesentery, and secures the extremities of the loop by careful stitching. Allingham<sup>2</sup> puts a stitch through the skin on one side, then through the mesentery behind the bowel, back again through the mesentery, and ties to the end of the suture passed through the skin.

Whether any stitches should be passed between the bowel wall and the skin edge after securing the mesentery will depend upon whether the bowel is to be opened at once or left for five or six days. In the latter case none need be inserted, but in the former, careful coaptation should be aimed at in order to prevent the possibility of any deep peritoneal contamination.

Where the mesentery is short, and a loop cannot be sufficiently withdrawn to admit of fixation as above described, Cripps's method of forming a sigmoid anus should be performed, a plan of operating which he adopts in all cases.

*Cripps's operation.*<sup>3</sup>—An incision  $2\frac{1}{2}$  inches long is made at right angles across an imaginary line drawn from the anterior superior spine to the umbilicus and  $1\frac{1}{2}$  inch from the superior spine. In order to make the opening somewhat valvular, the skin should be drawn a little inward and the tissues divided until the peritoneum is reached, when this should be picked up, and incised to nearly the full length of the cutaneous incision. The colon being found, a loop of it is drawn into the wound, and if loose folds of the sigmoid flexure remain immediately above the opening, it should be drawn down and passed through the fingers into the cavity at the lower angle. When this has been done, two provisional ligatures of stout silk are passed through the longitudinal muscular band opposite the mesenteric attachment 2 inches apart. The bowel is now temporarily returned to the cavity, and the parietal peritoneum is sutured to the skin on each side of the incision by two sutures of fine Chinese silk,  $1\frac{1}{2}$

<sup>1</sup> *Annual of the Universal Medical Sciences*, 1892, vol. iii. C—71.

<sup>2</sup> *Brit. Med. Journ.* 1889, vol. i. p. 769.

<sup>3</sup> *Ibid.*

inch apart, after which the bowel is fixed to the skin and parietal peritoneum by seven or eight fine sutures on each side, the last at each angle going across the one side to the other, and should be so attached as to have two-thirds of its circumference external to the sutures. The sutures for the lower side should be passed through the lower longitudinal band, as it is a strong portion of the bowel. Those for the upper should be inserted close to the mesenteric attachment.'

(4) *Prevention of prolapse*.—One of the most troublesome sequels to the formation of an artificial anus is the tendency of the bowel to prolapse through the opening. It may be the upper or lower segment which tends to project, but much more frequently it is the former. The most radical measure for the prevention of prolapse is that practised by Allingham.<sup>1</sup> After the abdomen is opened, the gut is drawn out and pulled upon till it is taut both above and below—in other words, the slack portion of the gut is pulled out. This is then fixed to the skin edges by suturing. In two or three days the gut is opened to allow the exit of wind; and in a week or so all the gut outside of the belly is removed close down to the skin. As much as a foot of bowel has been thus removed. Cripps pulls down the bowel until it is taut above, and tucks in the slack below (see operation above). He further believes that by making the incision through the parietes higher than the usual one, an additional inhibition to prolapse is added. He now makes it nearly as high as the level of the umbilicus, so that the wall of the lower half of the abdomen, where the pressure is greatest, is left intact.

Mansell Moullin,<sup>2</sup> after making the usual skin incision, 'slits the aponeurosis of the external oblique and merely separates the fibres of the subjacent muscles with the handle of a scalpel. When the loop of intestine which has been selected is drawn out, the aponeurosis on the inner side of the wound is lifted up for about an inch from the internal oblique, and an incision made in the direction of its fibres that distance nearer the middle line. The intestine is then slipped under the isolated strip, brought out through the second opening (the first being closed again with a suture), and fastened by transfixion of the mesentery in Maydl's and

<sup>1</sup> *Brit. Med. Journ.* 1892, vol. i. p. 1013.

<sup>2</sup> *Ibid.* 1893, vol. ii. p. 65.

Reclus' fashion, or in any other way that the operator prefers. By doing this the opening is made valvular, the muscles are placed in a position to acquire a certain constricting power over it, and the last inch or so of the intestine is made to lie at an angle with the part above.'

(5) *Prevention of involuntary evacuation.*—Unfortunately there exists no known means of preventing the escape of the fæces through the artificial anus. All mechanical contrivances, such as plugs, have proved failures. When once peristaltic action sets in, no artificial measures can check the fæcal outflow. The most that can be done is to endeavour to keep the fæces solid, and so regulate them that a movement may be expected at a more or less definite time, once in twenty-four hours.

(6) *Contraction of the orifice.*—It sometimes happens that the orifice becomes so contracted that a constant fæcal dribbling goes on, from the fact of the bowel never being properly emptied. The fault lies in the original opening being too small and the union of the surrounding edges taking place by granulation instead of by first intention. When undue contraction begins to show itself, the anus should be dilated daily by some form of dilator; and if this is not sufficient the orifice must be incised to the required extent.

Another method for forming an artificial anus in the sigmoid region is to make a transverse section of the bowel, close the lower end and return it into the abdomen, and stitch the other end to the wound. In adopting this method care must be taken to ascertain which is the proximal and which the distal extremity, otherwise the wrong end might be occluded.

**Lumbar anus.**—The first part of the operation resembles that for lumbar colostomy. After identifying the bowel, a knuckle is brought outside the wound and left *in situ*. No stitches, according to Bryant,<sup>1</sup> are necessary, the bowel needs only to be protected. On the fourth or fifth day the bowel is punctured with a tenotomy knife, and the opening enlarged for about half an inch in length.

There is no need to describe the operations for the formation of an artificial anus in other parts of the intestine. They

<sup>1</sup> *Harveian Lectures*, 1894, p. 39.

are carried out on much the same lines as those for the formation of a sigmoid or a lumbar anus.

**Closure of fæcal fistula and artificial anus.**—After the operations of colostomy and others of a similar nature in other parts of the intestine, it occasionally becomes necessary to close the fistula, and to do so an operation is requisite.

In the simplest cases, where, for instance, no obstruction any longer exists below the artificial orifice, and where the fistula is only prevented from closing by reason of a projecting process of mucous membrane, all that is necessary is to dissect away the latter and draw together the freshened skin edges.

In cases where the fistula is kept open on account of a projecting 'spur' which prevents the free passage of the contents of the bowel above into the segment below, means must be taken to remove it. The existence of a 'spur' indicates that a considerable portion of a knuckle of intestine is adherent to the parietes, and that the fistula approaches that of an artificial anus. The operation for the remedy of this condition is divisible into two stages: the first consists in the destruction of the 'spur;' and the second in the closure of the orifice in the bowel, and in the parietes. To remove the 'spur' various kinds of clamps have been invented. All have the object of causing the 'spur' to slough away by the continued pressure of the two blades of the clamp. An enterotome, originally invented by Dupuytren and known by his name, answers the purpose well.

To close the intestinal and the parietal orifices, the following method described by Chaput may be employed:

*Chaput's operation.*<sup>1</sup>—'The intestine is first separated from the abdominal wall and skin with a bistoury. The dissection should go to a depth of at least two centimetres, in order that the intestine may be sufficiently free, but it is not intended to open into the peritoneal cavity. The exuberant mucous membrane is cut away with scissors. The muscular tissue is vivified by cutting either with the scissors or by curetting for at least one centimetre all around the opening. The opposing lips of the intestine are then approximated by sutures which turn the free edges into the lumen of the gut. Deep catgut sutures are next used for the muscular layer of the abdominal

<sup>1</sup> Kelsey, *Annual of the Universal Medical Sciences*, 1891, vol. iii. D—10.

wall, and finally the epidermal layer of the skin is removed with a sharp curette before the last sutures are applied.'

In order to *close an artificial anus*, more radical measures than those above described are requisite. Nothing short of complete excision of the anus will in most instances suffice. The operation then becomes practically an enterectomy.

The skin is incised in the immediate neighbourhood of the anus, and the abdominal cavity opened. The adhesions uniting the involved knuckle to the parietes are severed, and the loop thus freed. The anus itself should be cleansed, and stuffed to a sufficient extent so as to check any possible contamination of the peritoneal cavity by the escape of fæcal material. The loop thus disengaged is brought out of the parietal wound as far as possible, and the operation of excision then proceeded with.

Senn,<sup>1</sup> in order to prevent more effectually the escape of fæces through the anus than can usually be accomplished by plugging the orifice, performs a preliminary transverse suturing of the intestinal opening. The sutures should include all the tunics of the bowel, and be placed so close together that any escape is impossible. With few exceptions this row of sutures will remain as Czerny sutures, to be buried, after the bowel has been detached, by Lembert stitches.

The same surgeon advises, when extraperitoneal methods are not applicable and intraperitoneal operations are contra-indicated, the formation of an anastomotic communication between the afferent and efferent limbs of the loop. The opening should be at least two inches in length, and performed either by using decalcified perforated bone plates or by employing the Czerny-Lembert method of suture.

In some cases of fæcal fistula, where no proper 'spur' exists, or, if present, it is too divergent to admit of the enterotome being safely applied, laparotomy with excision and suture will need to be performed. Or if the orifice be not too large, its edges may be pared and brought together by Lembert sutures; as was successfully accomplished in a case operated upon by McGill.<sup>2</sup>

<sup>1</sup> *American Journal of Obstetrics*, 1894, vol. xxx. No. 3, p. 343.

<sup>2</sup> *Lancet*, 1888, vol. i. p. 121.



## CHAPTER LXVIII

OPERATIONS (*continued*) : XI. APPENDICECTOMY

**XI. Appendicectomy.**—The operation consists in the removal of the appendix vermiformis for disease connected with the part.

*Operation.*—When appendicectomy is performed during the quiescent period in cases of relapsing appendicitis, the same precautions should be taken and the same preparations made as for any other operation upon the gastrointestinal canal. The bowels should be emptied by aperient medicines, and the use of copious fluid enemata on the morning of the operation. The skin is cleansed in the usual way, and proper attention is devoted to the clothing of the patient and the warmth of the operating room.

The patient is best placed on the operating table in the Trendelenburg position (i.e. with the pelvis well elevated), so that the small intestines will tend to fall away from the seat of operation. This position should not be assumed when there is likely to be a purulent collection about the appendix, for fear of septic material gravitating into the upper parts of the general peritoneal cavity.

*Skin incision.*—Much difference of opinion exists regarding the best line for opening the abdomen. By some the vertical incision is preferred. The peritoneal cavity is opened by a cut of two and a half or three inches in extent carried along the linea semilunaris, its centre being situated over the seat of the appendix. By others, again, the oblique incision is advocated. Treves,<sup>1</sup> who practises this incision, takes an imaginary line drawn from the anterior superior iliac spine to the umbilicus. The incision is about two inches in length, is placed at right angles to this line, and at a point about two inches from the spinous process. The centre of the incision corresponds to the line. McBurney<sup>2</sup> adopts the following method: ‘The incision in the skin is an oblique one about four inches long. It crosses a line drawn from the anterior iliac spine to the umbilicus nearly at right angles about one inch from the iliac spine, and

<sup>1</sup> *Brit. Med. Journ.* 1893, vol. i. p. 836.

<sup>2</sup> *Annals of Surgery*, 1894, vol. xx. p. 38.

is so situated that its upper third lies above that line. The incision of the aponeurosis of the external oblique is a little shorter, and practically merely separates the fibres of that muscle and its tendon without cutting them. The section of the internal oblique and transversalis muscle follows, cutting the muscular fibres nearly at right angles to their course, and is completed only at the central half at first. This deeper incision can be readily lengthened if, after cutting the fascia transversalis and peritoneum, the character of the lesion seems to call for more space.' When it is considered probable that only slight difficulty will be encountered in removing the appendix, and that a comparatively limited opening into the abdominal cavity will suffice, McBurney advocates that instead of *cutting across* the fibres of the internal oblique and transversalis, they should be *separated*, and held apart by a second assistant.

The desire to prevent the possibility of subsequent hernia has now led most surgeons to avoid opening the abdomen in the line of fibrous aponeuroses, and always to select incision and separation of the muscular layers. Battle<sup>1</sup> advocates an incision an inch and a half to the inside of the linea semilunaris, and divides the aponeurosis of the external oblique with the sheath of the rectus. The rectus muscle is then drawn to the inner side, and the posterior layer of the sheath and transversalis fascia exposed, the inner incision not corresponding to the external. The peritoneum is then divided. In closing the abdomen the layers are sutured from behind forwards, and as the rectus is allowed to return to its place, it thus interposes between the internal and external wounds in the abdomen.

*To find the appendix.*—After opening the abdomen, the surgeon introduces his index finger in search of the appendix, which, he must remember, may occupy one of several positions (see p. 490). If any difficulty is encountered, the margins of the incision should be held well apart by retractors, or the fingers of an assistant, and the cæcum identified. The latter is recognised by its pouched appearance, and by the existence of the three flat longitudinal muscular bands. If the anterior band be traced downwards, it will lead to the appendix (see Plate XXV, fig. 64). In cases of doubt regarding

<sup>1</sup> *Brit. Med. Journ.* 1895, vol. ii. p. 1360.

the direction of the colon, the application of a bit of sodic chloride is said to excite a reversed peristalsis, and thus indicate the direction to follow.

*To remove the appendix.*—When the appendix has been isolated and brought within the sphere of operation, the simplest and most rapid method of its removal consists in first tying and dividing its mesentery, and then passing a ligature tightly around it near its origin from the cæcum, cutting it off and then cleaning well or cauterising the end of the stump. This method may and frequently will do perfectly well. It leaves, however, an element of risk, in the piece of mucous membrane which is necessarily exposed and projects from the orifice of the stump. When the disease of the appendix originates in some inflammatory affection of the mucous lining, this latter is liable to prove an infective focus, and should therefore be securely dealt with. To attain this object several plans have been suggested. One of the simplest is to ligature and remove the appendix close to the cæcum, and then draw together by a few stitches a fold of the neighbouring peritoneum. The stump is thus buried. By some it is advised to scarify the serous membrane before uniting it over the stump.

Treves<sup>1</sup> employs the following method whenever possible. ‘A circular cut is made through the peritoneum, just on the distal side of the spot at which it is intended to sever the process. The peritoneum thus freed is turned back, like the skin in a circular amputation, and the appendix is cut across at the line of the reflected peritoneum. The mucous membrane which presents is scraped away with a sharp spoon. The muscular wall of the appendix is then brought together by means of a continuous suture of No. 1 silk braid. Over the stump thus formed the reflected peritoneum is drawn and secured in place by means of a few points of Lembert’s suture.’

A. E. Barker,<sup>2</sup> in order to attain much the same end, but with the expenditure of less time, advocates that the appendix be thus removed. ‘The mesentery is first transfixed and tied in one or two parts with fine silk; it is then cut with scissors up to the base of the appendix, close to the cæcum. Then, at

<sup>1</sup> *Brit. Med. Journ.* 1893, vol. i. p. 836.

<sup>2</sup> *Ibid.* 1895, vol. i. p. 863.

about three-quarters of an inch from the latter, the serous and muscular coats are divided by a circular sweep of a sharp knife, leaving the mucous tube intact. The latter is now gently drawn out, and the two outer coats are stripped back towards the cæcum with a director and turned over like the sleeve of a coat. In this way the tube of mucous membrane can be reached at its point of exit from the cæcum, and is tied with a fine silk ligature, and so closed. Then it is cut across an eighth of an inch beyond the ligature, and immediately retracts. The outer tube of serous and muscular tissue is now turned down over the stump of mucous coat, which has retracted towards the cæcum on being divided. This tube, formed of the outer coats, is then, instead of being stitched, simply surrounded with a fine silk or gut ligature, and closed over the mucous stump.'

The many complications and difficulties which may be encountered in attempts to remove the appendix have already been described (see page 513); and from a reference to these it will be seen what modifications of the above mode of operating may be necessary regarding the size and position of the skin incision, the mode of dealing with the appendix, and the after treatment of the wound.

**XII. Other operations.**—There are several other operations in which the bowel plays an important part, but which it is usual to describe under other headings. Thus the operation of gastro-enterostomy has been fully described in the operations upon the stomach. The operation of cholecyst-enterostomy is usually dealt with in works upon diseases of the gall bladder; a fistulous communication is formed between this viscus and the bowel. The operation of uretero-enterostomy consists in a lateral implantation of the ureters into some part of the intestine, usually the rectum or the colon. It has been successfully performed by, among others, Borri<sup>1</sup> in two cases. In one case it was performed for tuberculosis of the bladder; in the other for a large vesico-vaginal fistula with total destruction of the urethra. An operation which is called 'cystenterostomy' has been devised for establishing a communication between the posterior wall of an extroverted bladder and the intestine.

<sup>1</sup> *Brit. Med. Journ. Epitome*, 1896, vol. i. p. 1.

PART IV  
*THE RECTUM*

---

CHAPTER LXIX

ANATOMY AND PHYSIOLOGY. SURGICAL ANATOMY. METHODS  
OF EXAMINATION

**Anatomy.**—The rectum extends from the left sacro-iliac synchondrosis to the anus. It measures in the adult about eight inches in length, varying somewhat according to the height of the individual. In short women it may not be longer than five inches.<sup>1</sup> It takes a somewhat winding course, passing downwards from the left side above, to the median line, then following the concavity of the sacrum and coccyx, and finally turning sharply backwards round the latter to reach the anus. It is constricted at the anus, and slightly also at its commencement or junction with the sigmoid flexure; between these two points it is dilated. In shape it may be roughly likened to a club, the most dilated portion being below, about an inch within the anus. In some cases there is a tendency to pouching of the bowel forwards, immediately prior to its constriction at the sphincters. The rectum is kept in a more or less fixed position by means of the peritoneum and the recto-vesical fascia. The former, by its attachment to the sacrum behind, after surrounding the upper portion of the bowel, constitutes a meso-rectum, while the latter forms a sheath which surrounds and supports the lower segment.

In order to simplify the description of the rectum and its relations, it is divided into three parts—an *upper*, *middle*, and *lower*.

<sup>1</sup> Mathews, *Diseases of the Rectum and Anus*, 1892, p. 34.

The *upper or first portion* extends from the left sacro-iliac synchondrosis to the middle of the third sacral vertebra. It measures about three and a half inches in length, and is almost entirely surrounded by peritoneum. Posteriorly it is in contact with the pyriformis muscle, the sacral plexus of nerves, and the branches of the internal iliac artery of the left side, which separate it from the sacrum and the sacro-iliac joint. In front is the recto-vesical pouch in the male, and Douglas's pouch in the female, both of which contain coils of small intestine.

The *middle or second portion* extends from the middle of the third sacral vertebra to the tip of the coccyx. It measures about three inches in length, and is covered by peritoneum on the front and sides above, but only in front below. Posteriorly it lies in the hollow of the sacrum and coccyx, and in front it has the trigone of the bladder, the prostate, and the vesiculæ seminales and vasa deferentia in the male, and the vagina in the female.

The *lower or third portion* extends from the tip of the coccyx to the anus. It measures about an inch and a half in length. A triangular space intervenes between it and the membranous and bulbous portions of the urethra in the male, and between it and the vagina in the female. The lower inch of this part constitutes the anal portion of the rectum.

**Structure.**—The structure of the rectum resembles in many points that of the colon; it differs, however, in the distribution and arrangement of its coats. Thus the external or *serous coat*, formed by the peritoneum, only constitutes a tunic of the upper half of the rectum. It surrounds the upper portion, forms the front of the second part, and only exists on the upper part of the sides of the latter; the third part has no serous coat. The *muscular coat* is uniformly distributed around the bowel. The external longitudinal fibres are thicker above than below; while the internal are thicker below than above, forming the internal sphincter at the anus. The middle portion of the levator ani muscle is connected with the lower part of the rectum; its fibres are prolonged upon the bowel until they blend with the external sphincter. Cripps<sup>1</sup> maintains that the fibres of the levator

<sup>1</sup> *Diseases of the Rectum and Anus*, 1884, p. 8.

ani pass from the front and sides, backwards to the coccyx, and so encircle the bowel as to have a sphincter-like action upon it.

The *mucous membrane* is thicker, redder, and more vascular than that lining the colon. Like it, however, it is covered with the same columnar-shaped epithelial cells. The mucous membrane rests upon a comparatively lax submucous tissue, which admits of considerable freedom of movement upon the muscular coat. When in a contracted condition the mucous membrane is thrown into numerous longitudinal folds, which disappear on distension of the bowel. Other folds, transverse or oblique in direction, are more or less permanent. Three of these, larger than the rest, are known as Houston's folds. They are somewhat oblique in direction, and are half an inch or more in depth. 'One of these projects backwards from the upper and fore part of the rectum, opposite the prostate gland; another is placed higher up, at the side of the bowel; and a third still higher.'

The mucous membrane contains numerous crypts of Lieberkühn; and deeper than these glands, are scattered rounded lymphoid follicles resembling the solitary glands of the small intestine.

**Vessels and nerves of the rectum.**—The arteries which supply the rectum come from three different sources. Those to the upper part come from the inferior mesenteric, and are known as the *superior hæmorrhoidal*; those to the middle portion are the *middle hæmorrhoidal*, branches of the internal iliac; and those to the lowest segment the *inferior hæmorrhoidal*, branches of the pudic artery. In the upper half of the rectum the arteries perforate the muscular coat and form a network in the submucous tissue. In the lower half, the vessels, after penetrating the muscular coat, take a longitudinal course towards the anus, where they finally join by numerous transverse branches.

The *veins* follow the distribution of the arteries. Commencing as a plexus at the lowest part of the bowel, they pass upwards, and end by joining branches which terminate in the internal iliac vein and in the inferior mesenteric vein. Blood is thus returned to the vena cava, either directly through the iliac veins or indirectly through the portal system.

The *lymphatic vessels* are of large size. They pass from the bowel through small glands which lie on its outer wall, and then upwards by the meso-rectum to the sacral and lumbar glands.

The *nerves* are derived mostly from the pelvic plexuses of the sympathetic, which are derivatives of the hypogastric plexus, situated in front of the upper part of the sacrum. Some branches also pass from the sacral plexus of the cerebro-spinal system.

**Physiology.**—The rectum when at rest is usually empty, and the mucous walls in contact. The descent of fæces into the canal usually induces the act of defecation. The rectum can, however, act as a temporary receptacle for the fæces until their voluntary ejection. Normal defecation consists in the continuance of a peristaltic wave which commences in the intestine above and continues downwards, until the relaxed sphincters admit of the escape of the fæces. Too violent ejection is supposed to be somewhat checked by Houston's valves, which retard the downward progress of the fæces. These valves also serve to support the contents and prevent undue pressure upon the sphincters.

The action of the levator ani is considered by some to be of the nature of a sphincter; by others to give support to the lower part, and by contracting, to draw it up and invert its anal border after defecation.

The mucous membrane secretes mucus for the lubrication of the fæces, to facilitate their passage through the anus.

Free absorption of fluids takes place; and, as shown by the successful employment of enemata, the bowel also absorbs certain solid ingredients when administered in a suitable form.

**Surgical anatomy.**—When the finger is inserted into the rectum the involuntary contraction of the sphincters is felt for about an inch up the bowel. If the patient is made to voluntarily draw up the bowel, 'the upper margin of the contracted portion ends abruptly and gives a sensation of a broad muscular band round the bowel.' This Cripps<sup>1</sup> attributes to the voluntary contraction of the levator ani muscle.

With the finger thus inserted the shape and capacity of

<sup>1</sup> *Discases of the Rectum and Anus*, 1884, p. 3.



the bowel can be recognised. If the rectum be first partially distended with water, a better notion is obtained of its size.

While the finger cannot, in the majority of adult cases, reach much beyond three to four inches, this will as a rule embrace that part of the bowel which is uncovered by peritoneum. Downward pressure on the part of the patient increases the length which can be examined. The depth to which the recto-vesical peritoneal pouch may descend depends upon the empty or distended condition of the bladder. According to Cripps,<sup>1</sup> the distance from the anus to the peritoneum is only two and a half inches when the bladder and rectum are empty; but when distended, an additional inch is added.

In the male the finger within the rectum detects on the anterior surface, about an inch and a half to two inches from the anus, the prostate gland. In front of this exists the membranous part of the urethra which is recognised on the passage of a catheter. Posterior to the prostate is felt the apex of the trigone of the bladder, with the ejaculatory ducts, and the vesiculæ seminales on each side. In children the bladder in its entirety can be easily palpated bimanually. The finger can also detect the pulsation of the hæmorrhoidal arteries, and distinguish one or more of Houston's folds. Laterally there is felt the soft unresistant tissues of the ischio-rectal fossæ.

In the rectum of the female the os uteri is distinctly felt on the anterior wall; and anterior to this is the thin septum between the rectum and the vagina.

The upper portion of the rectum, and the parts in relation to it, can only be detected by the introduction of the hand. In addition to the facts ascertainable by the finger and given above, the following points are elicited: 'Through the posterior wall of the bowel the coccyx and sacrum can be felt, the curve of the sacrum being readily followed by the hand. The projecting spine of the ischium on each side of the pelvis is a valuable landmark. From this point the outlines of the greater and lesser sacro-ischiatic foramina can be traced by the fingers. . . . If the hand be now pushed farther up the gut, the promontory of the sacrum is reached; the pulsation of the iliac vessels becomes manifest, and the course of the

<sup>1</sup> *Diseases of the Rectum and Anus*, 1884, p. 3.

external iliac can be traced along the brim of the pelvis to the crural arch. . . . The internal iliac artery can also be followed to the upper part of the great sacro-ischiatic foramen. By semi-rotatory movement, and alternately flexing and extending the fingers, the hand can gradually be insinuated into the commencement of the sigmoid flexure. In the sigmoid flexure the fingers can explore the whole of the lower part of the abdomen. . . . In the female, the uterus in the middle line, and the ovaries on either side, can be readily distinguished.'<sup>1</sup> (Walsham.)

In introducing the hand into the rectum, two fingers should be inserted first, then the other two, and lastly the thumb. The passage of the hand is facilitated by freely lubricating it with vaseline or lard, and by the application of the other hand upon the abdomen. Progress should be effected by a careful rotatory motion of the hand. As regards the size of the hand which it is possible to introduce without causing immediate danger or subsequent incontinence of fæces, it naturally follows that the smaller the hand the less must be the untoward consequences. Walsham's hand measured somewhat less than seven and a half inches. Mathews<sup>2</sup> had success in using his hand, which measured eight and a quarter inches. Bryant,<sup>3</sup> in a case already quoted, succeeded with his hand, which measures nine and a quarter inches; and Mathews quotes Simon in maintaining 'that a hand measuring twenty-five centimetres (nearly ten inches) may be introduced absolutely without harm.'

*Method of performing rectal examination.*—Prior to any examination of the rectum, it is advantageous, when possible, to administer a water enema. One of three positions is usually adopted for examination. The patient is either placed on the side, or on the back, or on the knees and chest. In the lateral position, the patient lies on a couch or table of ordinary height, preferably on the left side, with the knees flexed and the thighs drawn up. In the dorsal position, the knees and thighs are flexed and abducted, the position being the same as that for lithotomy. In both these positions the pelvis should be raised upon a pillow, so that the intestines gravitate away from the

<sup>1</sup> *St. Bartholomew's Hospital Reports*, 1876, vol. xii.

<sup>2</sup> *Diseases of the Rectum and Anus*, 1892, p. 25.

<sup>3</sup> See p. 449.

pelvis. In the knee-breast posture, the patient kneels upon the table with the chest resting upon the arms folded across the table.

The index finger of the right hand is lubricated with vaseline or some ointment such as ung. hydrarg. By slow and gradual insertion the contraction of the sphincter is overcome, and the finger introduced without causing much pain.

When it is desirable to see the parts as well as feel them, one of the many forms of rectal speculum is introduced with the same precautions as the finger. If good natural light cannot be obtained some artificial means must be employed; and for this purpose, lamps with reflectors are sometimes used. An excellent method is to reflect a light from an ordinary laryngoscopic mirror fixed on the surgeon's forehead. Leiter's panelectroscope is also a convenient instrument for rectal illumination.

Whether the finger or the speculum be used, not only should the lining wall of the gut be carefully examined, but it should be noted whether either on withdrawal is tinged with blood, mucus, or purulent material.

---

## CHAPTER LXX

### INJURIES. FOREIGN BODIES. FÆCAL CONCRETIONS

THE deep and protected position of the rectum within the osseous walls of the pelvis renders it specially exempt from all those forms of injury which are liable to affect the other more exposed parts of the gastro-intestinal canal. The region of the perineum, and the orifice of the rectum itself, naturally form the most vulnerable parts. Hence nearly all injuries are inflicted by the impingement of, or the introduction of bodies into, this region. The only exceptions are gunshot wounds and severe fractures of the pelvis. In a case recorded by Earle,<sup>1</sup> a fracture of the pelvis caused an extensive laceration which communicated with the rectum.

Injuries which result from some impingement are among the commonest and most severe of wounds of this region. A

<sup>1</sup> *Trans. Med.-Chir. Soc. Lond.* 1835, vol. xix. p. 257.

fall upon some more or less hard and pointed body results in the latter entering the perineum and cutting or lacerating the walls of the bowel and the tissues surrounding it. Injuries of this nature are accidental. On the other hand, injuries of various degrees of magnitude have been produced by the voluntary introduction of agents of various kinds through the anus. In some instances, bodies have been introduced with the object of temporary concealment; while in others they have been employed for special purposes. Among the latter it is interesting to note that severe injury has been inflicted by surgeons in making use of the rectum for operative purposes elsewhere. Thus rupture of the rectum has followed its distension by Petersen's bag, in performing suprapubic cystotomy. Fowler<sup>1</sup> records such an instance, and refers to two others, by Cadge and by Nicaise. In all three a fatal result ensued. Another source of injury has been in the use of Davy's lever for compression of the common iliac artery in amputation at the hip joint; and a similar source is found in the forcible introduction of solid bougies for stricture, which have been made to perforate the upper part of the bowel wall and cause death by peritonitis. Such a simple procedure as the introduction of enemata has been followed by serious results. Nordman<sup>2</sup> refers to twenty-five such cases. They include three complete perforations and ulcerations, and wounds of various depths and sizes. The causes of these lesions seem to have been the use of defective instruments, ignorance of the direction of the rectum, catching of the transverse fold on the tube, extensive irritation of the mucous membrane of the bowel, and obstructions caused by certain conditions of the uterus, by the foetal head in parturition, or by an enlarged prostate. These lesions are usually found on the anterior wall of the rectum, from one to seven centimetres from the anus.

The rectum has also been injured by the surgeon in cutting for stone in perineal lithotomy, both in the median and the lateral operation.

Injuries usually of a slighter nature are effected by foreign

<sup>1</sup> *Annals of Surgery*, 1890, vol. xii. p. 129.

<sup>2</sup> *New York Med. Journ.* 1888, vol. xlvi. p. 43.

bodies passing into the bowel from above. These, however, will be alluded to later.

Ruptures, lacerations, and contusions of the anterior wall are produced during parturition. Injuries of this character are usually more fully described in works on Gynæcology.

*Nature of injury inflicted.*—The agent inflicting the injury chiefly determines the kind of lesion produced. It may be of the nature of a contused, incised, punctured, or lacerated wound. The higher the seat of the injury the more likelihood is there of the peritoneal cavity being involved. The extreme vascularity of the bowel, and the want of any firm support to the vessels, renders considerable hæmorrhage possible.

*Results of injury.*—Injuries which involve a part, and not the entire bowel wall, usually heal well. When, however, the whole thickness of the wall is involved, complications are liable to be present, or subsequently arise from injuries inflicted upon neighbouring parts. Complete perforation, rupture, or laceration occurring in the upper half of the rectum may open the general peritoneal cavity; while like lesions occurring lower down may open the bladder or urethra in the male, or the vagina in the female.

Inflammation arising as the result of injury may be limited to the bowel wall, causing either a localised or a general proctitis. This may end in ulceration or sloughing, especially if there has been laceration of the parts, and this, too, may end at a later period in the formation of stricture.

When inflammation has extended into the perirectal tissue, abscess may form, and if it does not discharge into the bowel, it may burrow and, as in the case narrated below, open externally. Abscesses which burst into the bladder may lead to recto-vesical fistulæ.

*Symptoms.*—The severity and nature of the injury will mostly determine the character of the symptoms. Bleeding may prove a prominent feature where much laceration of the bowel wall has taken place, but neither its presence nor its absence must be counted upon as any true criterion of the nature of the wound. Pain may be felt both in the region itself, and reflexly in other parts, as above the pubes, and in the perineum. Any 'movement' of the bowels will cause pain. These various symptoms become augmented if inflam-

mation sets in; fever and other constitutional disturbances are then added. In a case reported by J. H. Thompson,<sup>1</sup> there was a remarkable absence of all symptoms except abdominal pain, which, while only slight at first, became severe a short time before death. The case was that of a lad aged 18 years, who had fallen about four feet in a sitting posture on to the end of the upright shaft of a smith's hammer. It entered the anus, lacerated and passed through the rectum about three inches up, and carried a piece of cloth into the abdominal cavity, where it was found at the post mortem. In the motion and in the urine which were passed no blood was present, and the lad died on the same day from collapse.

**Treatment.**—The only immediate treatment that is likely to be required will be to check any undue hæmorrhage. When possible, bleeding points should be secured by ligature; failing such means, compression should be exercised by the insertion of a tube or catheter wound round with some antiseptic tissue to the required diameter. Any complication existing at the time, or arising subsequently, must be dealt with on general surgical lines.

CASE CII.—*Injury to rectum: abscess formation. Recovery.*

A farm labourer aged 35 years slid from the top of a hayrick on to a long-handled shovel. The handle entered his anus. The impetus of the descent carried him to the ground attached to the shovel, which he extracted, and which he said had entered to a depth of four inches. At the time of the injury he felt severe pain in the abdomen. His bowels did not act that day, although he several times felt a desire to go to stool. The following day he took castor oil, and repeated the dose the next day, when his bowels moved, and he then suffered from diarrhœa for several days. The pain in his abdomen persisted, and settled in the right iliac region. Four days after the accident he noticed a swelling in the right groin, which gradually extended over the outside of the right thigh. His temperature rose to 103°, and his general condition was that of one suffering from septicæmia. The right thigh became swollen and red, almost down to the knee. Palpation then elicited, on the front and outer part of the thigh, fluctuation and 'a squashing, gurgling sound.'

An examination of the rectum at this period detected, on the right side, about three inches from the anus, a roughly circular hole about one inch in diameter, with rugged edges; and a swelling could be felt occupying the right side of the pelvis.

On opening the swelling a quantity of exceedingly offensive gas and pus escaped. Improvement then took place for a time, when rigors and

<sup>1</sup> *Lancet*, 1887, vol. ii. p. 1110.

a high temperature appeared. This passed off, but a sinus persisted which opened and closed, sometimes emitting flatus, and sometimes an odourless, serous fluid. After two or three more relapses he eventually recovered. (P. L. Townley, 'Australasian Medical Gazette,' 1892, vol. xi. p. 398.)

**Foreign bodies. Fæcal concretions.**—By foreign bodies in the rectum is understood only such as become impacted and give rise to symptoms. The class is a large one, because it embraces two sources from which these substances may be derived. Either they descend into the rectum from above, or they are introduced into it through the anus.

With regard to the former source, the 'bodies' consist either of materials ingested or of those formed within the intestinal canal, mostly, however, of the former. These may be articles of ordinary diet, such as fish bones, chicken bones, and parts of foods which fail to be digested in their passage through the stomach and intestines; or they may consist of such foreign materials as nails, pieces of cloth, &c. Stalkert<sup>1</sup> records the case of a boy aged 10 years, whose rectum became blocked with a mass of wheat grains. The grains were swallowed entire, and had been taken by the boy from a vessel unloading in dock. The mass was scooped out from the rectum, and all symptoms disappeared. A very similar case is also recorded by Sympson,<sup>2</sup> where a quart of wheat grains was removed, the patient at once being relieved of his symptoms. An interesting account of twenty cases of foreign bodies impacted in the rectum is given by Goodsall;<sup>3</sup> the materials consisted in almost all instances of bones, mostly from fish. Some of the inferences drawn from these cases are, that the accident is more commonly met with after thirty-five years of age: that a bone takes from one to nine days to pass from the mouth to the rectum: that the pain comes on suddenly while the motion is being passed: that there is constant pain or discomfort in the rectum and sometimes also in the subjacent parts, from the time of the puncture until the foreign body has been removed; and that the site of the puncture is within the last inch or three-quarters of an inch of the anus.

<sup>1</sup> *Erit. Med. Journ.* 1890, vol. ii. p. 685.

<sup>2</sup> *Ibid.* p. 790.

<sup>3</sup> *St. Bartholomew's Hospital Reports*, 1887, vol. xxiii. p. 71.

When derived from the latter source, there is no limit to the extraordinary number and nature of the articles which patients from most varied motives may introduce into the rectum. The following briefly abstracted cases will sufficiently indicate a few of these aberrant features.

Lowe<sup>1</sup> reports the case of a man aged 70 years, who, wishing to commit suicidé, pushed up his rectum the handle of a drawer of a kitchen dresser; it measured two and three-quarter inches in circumference. Jenkins<sup>2</sup> records the case of a man who was robbed of his money, and prevented from following the thieves by the pain caused by a turnip and a potato which they had forcibly introduced into his rectum. The potato had been previously fitted into a hole in the turnip; the dimensions of the bulk were ten and a half inches in its bipolar circumference, and eight inches round. Warren<sup>3</sup> relates the case of a man who for sexual purposes introduced a catsup bottle up his rectum. The bottle measured nine inches in circumference and was ten inches in length. It was removed by incising the sphincter. Other cases are quoted. Spanton<sup>4</sup> records the case of a man who, for the purpose of pushing up the bowel some butter which he was in the habit of using for destroying 'seat worms,' sat upon a hock bottle. As all attempts at removal from below were fruitless, the bottle was removed by colotomy. The patient died the following day. The bottle was eleven inches long, and two and a half inches in diameter at its lower part. Simmons<sup>5</sup> reports the case of a man who used a stick, ten inches long and two-thirds of an inch in diameter, to push up his piles. The stick slipped out of his reach, and was successfully withdrawn with the small obstetric forceps.

For many other curious and remarkable illustrations of this condition, Poulet's exhaustive treatise upon 'Foreign Bodies in Surgery'<sup>6</sup> should be consulted.

The *impaction of feces* within the rectum owes its origin to various causes. In some cases a want of tone in the muscular wall of the bowel allows of a gradual distension of the part. As a result of prolonged retention, and the consequent

<sup>1</sup> *St. Bartholomew's Hospital Reports*, 1891, vol. xxvii. p. 57.

<sup>2</sup> *New York Med. Journ.* 1894, vol. lix. p. 531.

<sup>3</sup> *Boston Med. and Surg. Journ.* 1890, vol. cxxii. p. 543.

<sup>4</sup> *Brit. Med. Journ.* 1881, vol. i. p. 848.

<sup>5</sup> *New York Med. Journ.* 1894, vol. lix. p. 596.

<sup>6</sup> Vol. i. p. 217.



absorption of all fluid constituents, the fæcal mass assumes a more solid and compact consistency until it forms a hard mass which no voluntary effort on the part of the patient can expel. In other cases a concretion, which may possibly have a fish bone or other like substance as a nucleus, forms in the bowel above, and then descending into the rectum, gets lodged in a mucous fold or pouch, where by fæcal accretion it enlarges, and finally becomes too large for expulsion. Fenwick<sup>1</sup> records the case of a man who for some years had suffered from chronic cystitis and constant diarrhœa with frequent desire to empty his bowels. On examination of the rectum a calculus was felt, and withdrawn with some difficulty by a pair of lithotomy forceps. The rectal symptoms disappeared, and the bladder trouble markedly decreased. The calculus weighed an ounce and a half, and on section a plum stone was found forming a nucleus to several laminæ of concentrically disposed resinous material.

**Symptoms.**—Considerable variation necessarily exists in the symptoms which may be present in any case of impacted foreign body, for the patient's sufferings must largely depend upon the character of the body impacted and the injury inflicted upon the bowel wall. Further, the completeness with which the canal is blocked will influence very naturally the amount of constitutional disturbance.

In its simplest effects a foreign body may cause no further distress than an ill-defined sense of discomfort, from which the patient only gets relief by a complete evacuation of the bowels. In cases, however, where the impaction means some perforation of, or undue pressure upon, the bowel wall, pain becomes a prominent and often excruciating symptom, felt in the region itself, and often in the abdomen, and in the perineum.

The patient frequently becomes greatly distressed at his own ineffectual efforts at extraction or expulsion, and constant straining and ténismus leads to a patulous and swollen condition of the mucous membrane at the anus. Frequency of micturition may exist either from undue pressure upon the bladder or from reflex nerve irritation. Pressure on the sacral plexus posteriorly may cause pain to radiate down the lower extremities. Blood, in variable quantity, is occasionally

<sup>1</sup> *Trans. Path. Soc. Lond.* 1886, vol. xxxvii. p. 261.

discharged from the anus, and as time progresses, this may be mixed with mucus or pus, indicating the appearance of inflammation and ulceration. Constipation is a common symptom in most cases; but while no solid motion is passed, some offensive slimy material is frequently expelled, as the result of constant efforts to get relief. A curious exception to the usual symptoms met with in this class of cases is afforded by a case recorded by Lowe.<sup>1</sup> A lady aged 57 years always felt as if the action of her bowels was incomplete, although well-formed motions were passed. On digital examination of the rectum, a foreign mass was felt to have been caught by a fold of mucous membrane, which formed a pouch in which it rested. It was the size of a turkey's egg. All symptoms disappeared after its removal.

**Diagnosis.**—Much difficulty frequently exists in attributing the symptoms to their true cause, and in detecting the presence of a foreign body when suspected. Most difficulty in diagnosis is encountered in those cases where the foreign body has descended from above into the rectum. Whether the obstruction be complete or only partial, it is often only by careful digital examination that the source of the trouble is found. Should perchance the 'body' or 'bodies' be impacted at the upper part of the rectum, the real source of obstruction may not be detected until after the abdomen has been opened. 'Bodies' introduced *per anum* do not as a rule pass out of reach of the finger; exceptions, however, occasionally occur, as instanced by Simmons' case narrated above. In this latter class, assistance is often obtained from the confession of the patient, the severity of whose symptoms no longer permits him to conceal the true cause of his sufferings. The best indication of the existence of an impacted foreign body is the sense conveyed to the patient of something within the rectum which constant calls to stool fail to relieve.

**Prognosis.**—If the foreign body has remained only a short time impacted, and the immediate injury to the bowel is only slight, removal should be followed by complete and permanent relief. If on the other hand the impaction is prolonged, many complications may arise, dependent upon the nature of the agent and its effect upon the bowel wall. Thus inflammation,

<sup>1</sup> *St. Bartholomew's Hospital Reports*, 1891, vol. xxvii. p. 58.

ulceration, or sloughing may occur, with possibly later perforation. Should these processes take place in the upper part of the rectum, the peritoneum may become involved, and then either a local peritonitis set up, with possibly abscess formation; or a more general peritonitis may arise and prove fatal.

When ulceration takes place nearer the anal extremity of the gut, a perirectal abscess may form, and bursting externally somewhere in the perineum, give rise to one of the forms of fistula *in ano*. Fistulous communications may also be formed between the bladder or urethra in the male, and the uterus or vagina in the female.

In cases of less extensive injury to the bowel wall, such for instance as more frequently occurs when feces are impacted or the foreign bodies pass into the bowel from above, the mucous membrane becomes inflamed from the constant irritation to which it is subjected. In some cases this irritation leads to nothing more than a slight catarrhal inflammation; in others, however, its severity causes the condition to be almost dysenteric in character. Such was the case in the illustration given below, where the patient was at first supposed to be suffering from an attack of acute dysentery.

When the rectum is completely blocked by the impacted mass, so that flatus cannot pass, symptoms of acute intestinal obstruction set in, less in severity as a rule than in cases of obstruction higher up the bowel.

**Treatment.**—In almost all cases of foreign bodies in the rectum, whether introduced from below through the anus or descended from above, mechanical measures alone are of service in effecting removal. When within reach of the finger, a careful examination should be first made to ascertain the nature and situation of the obstructing agent. If it be found too large to be easily withdrawn, the anus should be dilated, so as to avoid any undue laceration of the parts. Should difficulty still exist, a free incision may be carried through the sphincter backward towards the coccyx. By traction and rotatory movements, exercised either with the fingers or with forceps, most obstacles can be removed.

In cases where the 'body' has been forced up beyond the reach of the finger, much difficulty may be encountered in

attempting its withdrawal. If extraction cannot be effected by a long pair of forceps, the surgeon is forced to the ultimate resource of sigmoidotomy, as practised by Spanton in the case recorded above.

When the rectum is obstructed by hard fæces, or foreign bodies which have passed into it from above, the finger is frequently capable of breaking down the mass and dislodging it by fragments. Failing the finger, a scoop or spoon will usually prove successful.

If there is reason to fear that the rectum has already suffered injury, either from the prolonged retention of the foreign body or from the special nature of the impacting agent, or perchance during the process of removal, every care must be taken to give the parts rest. The patient should be confined to bed, mild aperients administered to keep the motions soft, and in some cases the bowel washed out with warm water. All complications must be treated on general surgical principles.

CASE CIII.—*Impaction of seeds, fruit stones, and husks in the rectum : acute proctitis : removal. Recovery.*

A boy aged 10 years had suffered for some days from what was supposed to be a severe attack of dysentery. When received into hospital on the eighth day of his illness, he was compelled to go to stool every half-hour. He passed very small quantities at a time, not much more than a teaspoonful. The evacuations were very offensive, yellowish, slimy, and tinged with blood. Defecation caused much pain, and was accompanied with involuntary evacuation of urine. In appearance he was in a wretchedly depressed condition, with sunken eyes and a heavy facial expression. His pulse was weak, his tongue furred, and his breath very fetid. In any movement of his body the abdominal muscles were rendered rigid. The skin about the anus was very much reddened and excoriated, while the anus itself gaped to the extent of a one- or two-shilling piece; hanging from the margin of the orifice were shreds of tissue. When, in the course of treatment of the supposed dysentery, an endeavour was made to wash out the bowel, it was found that the catheter would only enter a short distance. The finger also could enter no further, but a pointed body was felt which when extracted with a pair of forceps proved to be black seeds. Other endeavours were then made, and about half a cupful of seeds and husks was removed. It was noted that the pointed ends of some of the seeds and husks stuck into the mucous membrane. The seeds, which the boy on seeing confessed to have eaten, proved to be those of the sunflower. On the two following days, washing out the rectum brought away more than a cupful of the seeds. The boy

remained in much the same state: tenesmus with the passage of slimy yellowish stools. Two days later, masses of necrotic tissue were passed, and the motions also contained purulent matter. From this period onward, however, he gradually improved, and eventually quite recovered. (Goerne, 'Berliner klin. Wochenschrift,' 1891, vol. xxviii. p. 34.)

---

## CHAPTER LXXI

### DISEASE. INFLAMMATION: PROCTITIS, PERIPROCTITIS. NON-MALIGNANT ULCERATION

IN discussing diseases of the rectum, it is only intended to deal with such as involve the strictly intestinal portion of the canal. Hence such affections as hæmorrhoids, fistula *in ano*, fissure, and anal ulcer, which implicate the anus and an inch or so of the bowel above it, do not come within the scope of the present work.

The diseases to be considered are inflammation, ulceration, non-malignant stricture, carcinoma and sarcoma, innocent tumours, prolapse, neuroses, malformations, and conditions dependent upon external influences.

**Inflammation.**—Involvement of the bowel wall alone, constitutes proctitis, while implication of the tissues around it is termed periproctitis.

**Proctitis.**—The inflammatory action may be acute or chronic, local or general. In the acute form the mildest manifestation is that of a simple catarrh of the mucous membrane, while its severest type is met with in some of the more virulent cases of dysentery. The disease may arise from some local irritation or from infection. In the former case it may be the result of injury, of foreign bodies, intestinal worms, fæcal accumulation, or it may be due to the administration of drastic purgatives either by the mouth or by injection. In a case reported by Gibbs,<sup>1</sup> severe proctitis resulted from the injection of pure carbolic acid into internal hæmorrhoids. Not infrequently some inflammation exists in cases of stricture, whether simple or malignant, and in polypus.

Inflammation the result of infection arises from gonorrhœa, diphtheria, and erysipelas. In these cases the virus is

<sup>1</sup> *New York Med. Journ.* 1892, vol. lvi. p. 93.

usually carried to the part either by extension from the vagina in the case of the female, or by direct introduction from without. In the case of gonorrhœa it has been known to follow sodomy.

Dysentery constitutes a disease of itself, and often implicates some portion of the colon as well as the rectum.

**Symptoms.**—In its mildest form inflammation of the rectum is recognised by a reddened and swollen condition of the mucous membrane, which sometimes protrudes from the anus. Tenesmus is frequently present, and mucus in variable quantity is passed, sometimes alone, at other times mixed with the fæces. The condition of the bowels varies, sometimes being constipated, at other times relaxed. Some degree of pain is usually felt in the rectum, and this may radiate to the back and down the limbs.

The more acute the inflammatory process the more prominent become these symptoms. Instead of mucus in the evacuations, they may contain pus and blood; the pain assumes more of a burning character. Digital examination causes considerable pain, while the finger detects a heated and swollen state of the mucous membrane. In addition to these local symptoms there may be more or less constitutional disturbance. The patient will be feverish, with loss of appetite, loss of sleep, and other disturbances dependent upon these conditions.

The constant discharge of mucus and inflammatory products from the rectum is liable to produce an inflamed, excoriated, and painful condition of the anus and the skin around.

In some cases there is frequency of micturition, due to the reflex irritation of the bladder.

In the severest form of acute proctitis—that due to dysentery—there is more disturbance, both constitutionally and locally, than is usually met with in inflammation arising from other causes. The disease should be studied in works on medicine, where it finds a more fitting place for discussion than in a work on surgery.

Prolonged acute inflammation may lead to grave secondary lesions, such as ulceration, perirectal inflammation, abscess, and peritonitis.

*Chronic proctitis* may either exist as such from the outset,

or it may follow upon an acute attack. The symptoms are much less severe, and consist chiefly in the discharge of mucus with the motions, which as a rule are rather solid than loose, and are passed infrequently. Prolonged inflammation may lead to contraction of the calibre of the canal, and this may finally end in ulceration or stricture.

**Treatment.**—Attention must be directed in the first place to the cause of the condition. When this is of a removable nature, all symptoms may rapidly subside on its being efficiently dealt with. Should, however, the inflammation continue, both local and general measures must be adopted. The patient should be confined to bed, and placed upon a diet of a bland and simple kind. Mild laxatives should be administered if there is a tendency to constipation. Hot hip-baths may relieve the pain and also lessen the congestion. If local applications are considered requisite, water as warm as can be borne should be injected, and the addition of a few drops of laudanum will assist in producing a soothing effect. In chronic cases astringents such as alum and tannin should be injected.

The treatment of dysentery hardly calls for any remarks by the surgeon, and would not be mentioned here were it not for the fact that it, like chronic membranous or ulcerative colitis, has in recent years yielded to the surgeon's operative measures where the physician's therapeutic efforts have failed. At a meeting of the Clinical Society of London in December 1895, Godlee<sup>1</sup> mentioned a case of dysentery in which much improvement had followed upon opening the colon. The rationale of such treatment exists in the complete rest afforded the inflamed and ulcerated mucous membrane by the temporary diversion of the fæces through an artificial anus. As illustrating a case of severe proctitis, the one reported under the heading of 'Foreign bodies' serves as a good example (see p. 576). The following equally well illustrates the same disease, due, however, to another cause.

CASE CIV.—*Acute proctitis the result of taking large doses of patent cathartic remedies.*

A woman aged 23 years had always been constipated, and for years had been in the habit of using purgatives whenever she desired an evacua-

<sup>1</sup> *Brit. Med. Journ.* 1895, vol. ii. p. 1559.

tion. For the past six months she noticed occasional discharge of blood and slime from the rectum, which was constantly increasing. She now suffered great pain on defecation, and the amount of blood and mucopurulent material increased to such an extent that, while at first it only came when at stool, it had subsequently been coming several times a day. She suffered pain in the rectum at all times. Her general condition was poor; she had lost her appetite, and was unable to sleep.

A careful examination of the rectum showed it to be congested, hot and painful as far as the eye could see. The amount of discharge suggested gonorrhœa of the rectum, but there was no inflammation of the vagina, and no reason from the history of the case to suspect it. The real cause appeared to be in the habit which she had contracted of taking large doses of patent cathartic remedies two or three times a week in order to overcome her chronic constipation. (Charles B. Kelsey, 'Diseases of the Rectum and Anus,' 1883, p. 67.)

**Periproctitis.**—Inflammation of the tissues around the rectum occasionally arises as an extension from inflammation of the rectum itself; as often, however, it owes its origin to some cause situated without the rectum. It may be local or general—in other words, it may consist in the formation of a circumscribed abscess, or in an acute cellulitis involving a considerable extent of the perirectal tissue.

The localised or circumscribed form of periproctitis frequently owes its origin to the extension of a perforative ulceration. This ulceration may result from injury, direct or as the result of a foreign body, to stricture, or to any of those causes which will be found more fully described under the heading of 'Ulceration.' The situation of the inflammatory focus is important as bearing upon the possible complications which may arise. Thus, when located below the levator ani, the abscess may burst in one or more places on the perineal surface; and should a communication also be formed with the rectum, one form of fistula *in ano* would result. On the other hand, with an abscess arising above the levator ani, a rupture might take place into the bladder or the peritoneal cavity.

A form of periproctitis, described as gangrenous, is occasionally met with in men addicted to good living and free drinking. The inflammation is of a severe type, and involves considerable necrosis of cellular tissue around the lower part of the rectum. Both ischio-rectal fossæ are infiltrated with inflammatory products; the skin around the anus becomes reddened



and almost livid in appearance ; there is much pain, and the patient usually suffers from fever and other constitutional disturbances. The treatment consists in free and deep incisions into the ischio-rectal fossæ.

In other cases of localised or general periproctitis, efforts should be made to prevent the advance of the inflammation to suppuration by the injection of hot water and the administration of laxatives. When it is to be feared that suppuration is commencing, the bowel wall should be incised, and relief thus afforded to the congested and inflamed area.

**Non-malignant ulceration.**—In the majority of instances ulceration is the sequel to inflammation, and may therefore be met with in the later stage of all those inflammatory affections which have just been described. These causes, briefly recapitulated, are injury, either direct or from the presence of foreign bodies, fæcal retention or impaction, drastic purgatives, chronic diarrhœa in children, polypus, stricture, dysentery, gonorrhœa, and diphtheria. In addition to these must be added ulcers resulting from tuberculosis, syphilis, varicose veins, and from special causes arising without the bowel, such as those connected with parturition and vaginal affections.

Non-malignant ulceration is much more frequently met with in women than in men. In Poelchen's<sup>1</sup> series of 219 cases, to which reference will again be made, 190 were women, 25 men, 2 children, and 2 in which the sex is not given. This author assigns as one reason for this greater frequency of ulceration in women, the common occurrence of recto-vaginal fistula. Thus in the above list of 190 cases recto-vaginal fistula was found present in 46.

While it is possible to enumerate the various probable causes of ulceration, it is by no means so easy to ascribe to any particular lesion its true cause. In cases where there is a definite history of injury, disease, or previous inflammation of some recognised kind, little difficulty exists in determining the cause ; but these cases may be said to constitute the minority. In the large proportion of cases no definite predisposing or exciting cause is ascertainable ; and the

<sup>1</sup> *Archiv für path. Anat. und Phys.* 1892, vol. cxxvii p. 189.

somewhat unreasonable custom in the past has been to ascribe these otherwise inexplicable ulcers to syphilis. The tendency, however, of modern surgeons is to find other explanations of their existence, and not to relegate to syphilitic action that which cannot be ascribed to anything else, and which has not, in many cases, even the evidence or history of the constitutional disease to support it.

Ulceration of the rectum presents features very much the same, no matter what the cause. It may be so slight that it consists of little more than a superficial erosion of the mucous membrane. While on the other hand it may extend so deeply as to cause perforation of the bowel wall and establish communications with the tissues and parts around. Again, the ulcers may be single or multiple, and vary in size from a small point, as in the follicular ulcer of infantile diarrhoea, to involvement of almost the entire bowel wall, as is sometimes seen in dysentery and in slowly progressive chronic ulceration (see Plate XXVI, fig. 99). The character of the ulcer also varies according to its acuteness or chronicity, such variations being indicated by the amount of induration or vascularity of its base and edges. The tendency which most ulcers of the rectum have to spread and coalesce naturally gives rise to considerable variation, dependent upon the stage at which the process has arrived, or, in other words, the time during which it has been going on.

Among the ulcerative processes which call for a more detailed description are the dysenteric, the tubercular, the syphilitic, the varicose, and those dependent upon special causes, such as parturition and vaginal inflammation.

*Dysenteric ulceration.*—As most frequently met with in mild cases, the initial inflammatory process gives rise to follicular ulceration, so that the bowel surface presents numerous small ulcers, at first superficial and discrete, but later becoming deeper and confluent. In the severer types of the disease, large ulcers result from the necrosis of patches of mucous membrane, due to the detachment of the part by extravasated blood. Such extensive and deep ulceration leads sometimes to perforation, with all the consequences dependent upon abscess formation and fistula. As a feature somewhat distinctive of this kind of ulceration in its acute stage, the mucous

PLATE XXVI.

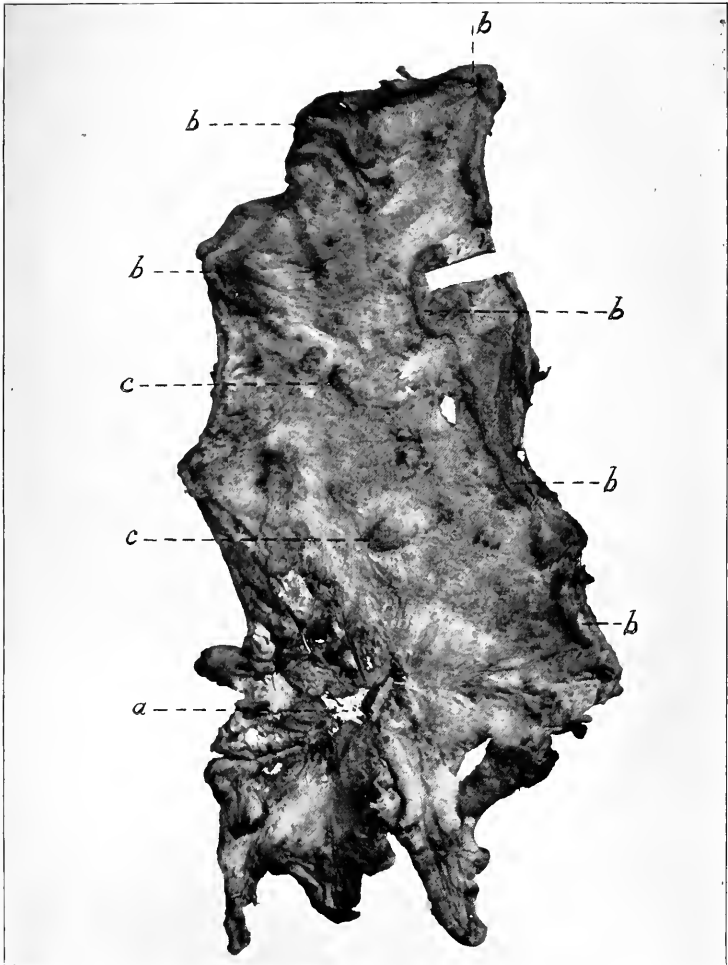

Fig. 99.—EXTENSIVE CHRONIC ULCERATION OF THE ENTIRE RECTUM.—*a*, Healed cicatricial part situated just within the anus; *b*, the margins of the ulcer formed of normal mucous membrane; *c*, islets of mucous membrane situated in the base of the ulcer. (*V.I.M., Glas.*)



membrane around the centres of necrosis is frequently acutely inflamed and much swollen.

As the disease subsides, the acute inflammatory process also diminishes, and the rectum then presents the more typical characters of limited and uncomplicated ulceration. It is in this condition that the disease is most frequently presented to the surgeon; and which, in the process of healing, may give rise to one of the forms of non-malignant stricture.

CASE CV.—*Dysenteric ulceration of the rectum.*

A child aged 5 years had suffered from attacks of dysentery for more than a year. For two months previous to admission into hospital, it had had from two to four bloody movements each day. On examination with the speculum, the whole mucous membrane was found congested. Just inside the sphincter there were many small ulcers, and situated from three to five inches from the anus there were several large ones, measuring two inches in length and half an inch in width. He was put on sterilised milk, and given three grains of citrate of iron and quinine, three times daily. The rectum was irrigated four times daily with a saturated solution of boracic acid, and a suppository of iodoform gr. ii and sub-nitrate of bismuth gr. v inserted after each irrigation. Rest in bed. With some other slight variations in the treatment, the child made a good recovery in the course of three months. (Acker, 'Archives of Pediatrics,' 1892, vol. ix. p. 438.)

*Tubercular ulceration.*—The process by which the rectum becomes involved in tubercular disease differs in no respect from that which occurs in other parts of the intestinal canal. As in these also, the disease is usually a concomitant of disease elsewhere, most frequently of pulmonary phthisis.

The process commences by the deposition of tubercle in and beneath the mucous membrane; these deposits caseate and break down, and when several are in close apposition, the result is an irregular destruction of tissue, with the formation of an ulcer.

The ulcers follow the usual type of tubercular ulceration elsewhere; the edges are frequently thin and undermined; the surface is more or less smooth and glazed in appearance; the outline is irregular, and the tendency of the ulcer is to extend both superficially and deeply. If the bowel wall is perforated, abscess may result, and this bursting into some other part may lead to complications similar to those already

alluded to as liable to result from all perforative processes of ulceration.

In and around the ulcer, nodules are often seen. These are deposits of tubercle, and constitute one of the typical features of the ulceration.

The usual course of the disease is to progress; when, however, healing takes place, stricture may follow as the result of the repair.

CASE CVI.—*Tubercular ulceration of the rectum: phthisis.*

A man aged about 40 years complained of discharging some mucus each day, accompanied by a good deal of tenesmus, but with no pain. On examination of the rectum a distinct ulcer was found, beginning just above the sphincter and extending upwards. It was somewhat conical in shape, the base being below. It had the peculiar characteristics of a tubercular ulcer. There was no pus. The base was a glairy, palish red. There were no well-defined edges, although the ulcer had some depth. No particular pain was noticed when it was touched. The treatment advised was the application of stimulating lotion to the ulcer, and strict attention to cleanliness and the patient's general health. There were marked symptoms of pulmonary phthisis present. (Mathews, 'Diseases of the Rectum and Anus,' p. 325.)

*Syphilitic ulceration.*—The frequency with which syphilitic ulceration occurs is probably much less than was at one time supposed. The tendency to ascribe to syphilis all ulceration which could not be accounted for in any other way, is as unreasonable as it is erroneous. The absence of any specific history should in the majority of instances as certainly exclude syphilis in the rôle of causes as the absence of a history of dysentery would be considered sufficient to exclude that disease. And the additional fact that any ulcer is not affected by antisiphilitic treatment, should render even the suspicion of a specific taint untenable.

That ulceration may result from syphilis is another question, and one which most surgeons would answer in the affirmative. It invariably arises from the breaking down of gummata deposited in the submucous tissue. It occurs as a late and tertiary lesion of the disease. The breaking down of a gumma gives rise to a circular ulcer with sharply defined margins and a vascular base. When two or more deposits coalesce, the ulcer becomes irregular in outline and uneven on its surface. As in the tubercular form of ulceration,

the destruction of tissue may extend deeply and give rise to the same train of complications. Cicatrisation of an extensive ulcer may lead to one of the forms of rectal stenosis. (See Syphilitic Stricture.)

Another way in which the rectum may be affected by ulceration is from the extension of specific sores and ulcers which originate around the anus.

*Varicose ulcer.*—It is reasonable to suppose, and there is evidence to show, that simple ulcer may form in the rectum as the result of a congested condition of the mucous membrane from varicose veins, just as the same kind of lesion arises from varicose veins in the leg. The only exciting cause necessary to start the process is some slight abrasion; and this is readily enough found in hardened and retained fæces. Gibbs,<sup>1</sup> who has devoted considerable attention to this kind of ulceration, states that in nine out of ten cases the ulcer involves only a small area, from the size of a thumb nail to that of a 'silver quarter.' Most frequently they are situated posteriorly, and from one to two inches from the anus. The muscular coat is seldom penetrated. The diagnostic features of this kind of ulcer are: (1) The lack of any tangible or definite cause; (2) their occurrence in otherwise healthy persons; (3) their extreme chronicity; (4) their amenability to proper treatment; and (5) the frequently marked evidence of hæmorrhoids. The special treatment advised, beside that usually adopted in all cases of rectal ulceration, is to make a longitudinal incision through the base of the ulcer, deep enough to sever the underlying circular muscular layers. This cut is to be continued through the anus with the object of securing drainage and preventing inflammation in the tissues around.

CASE CVII.—*Simple ulcer of the rectum due to varicose veins.*

A gentleman aged 35 years had suffered intermittently, and more or less severely, with pain of a dull aching character, coming on after defecation. A discharge of pus and blood was noticed, and was always most marked in the morning. When a rectal examination was made, an ulcer about the size of a quarter-dollar was found two inches from the anus. The ulcer appeared healthy, not deep or punched out, and had no overhanging edges. The granulations were soft and bled on touch. There was no

---

<sup>1</sup> *New York Med. Journ.* 1892, vol. lvi. p. 93.

assignable cause. Syphilis could be absolutely excluded, and the general health was unusually robust. His condition had been stationary for years, and showed no tendency to improve. By special care, however, complete cicatrisation of the ulcer occurred in three months. (John Blair Gibbs, 'New York Med. Journ.' 1892, vol. lvi. p. 93.)

*Ulceration from other causes.*—There are two other causes of ulceration in the rectum, which serve, to some extent, to explain the greater frequency of the condition in women. One occurs as the result of parturition, and the other from inflammation of Bartholin's glands. In the former case the ulceration results from the destruction of tissue in the upper part of the rectum, caused by its being unduly pressed upon, or perchance lacerated in the passage of the foetal head through the pelvic cavity.

Ulceration secondary to inflammation of Bartholin's glands is a theory propounded by Poelchen, and has been carefully worked out in the paper already referred to. The theory is that inflammation and suppuration of these glands lead to perforation of the rectum and ulceration, the immediate result being the formation of a recto-vaginal fistula. In this way, he believes, is to be explained the large proportion (46 out of 190) of recto-vaginal fistulæ met with in his series of cases.

**Symptoms.**—So graphically does William Allingham describe the symptoms of rectal ulceration, that I venture to give a complete abstract from his work on 'Diseases of the Rectum.'<sup>1</sup>

'In the majority of these cases the earliest symptom is morning diarrhœa, and that of a peculiar character; in my opinion it is quite indicative of the disease, and can be confounded only with similar symptoms due to cancer. The patient will tell you that the instant he gets out of bed he feels a most urgent desire to go to stool; he does so, but the result is not satisfactory. What he passes is generally wind, a little loose motion, and some discharge resembling "coffee grounds" both in colour and consistency; occasionally the discharge is like the white of egg; or a "jelly fish;" more rarely there is matter. The patient in all probability has tenesmus and does not feel relieved; there is a burning, some-

<sup>1</sup> 4th edit. p. 226.



what uncomfortable sensation, but not actual pain; before he is dressed he very likely has again to seek the closet; this time he passes more motion, often lumpy and occasionally smeared with blood. It may also often happen that after breakfast, hot tea or coffee having been taken, the bowel will again act; after this he feels all right, and goes about his business for the rest of the day, only perhaps being occasionally reminded by a disagreeable sensation that he has something wrong with his bowel. Not by any means always, but at times, the morning diarrhœa is attended with griping pain across the lower part of the abdomen, and great flatulent distension. When a medical man is consulted the case is, in all probability, and quite excusably, considered one of diarrhœa of a dysenteric character and treated with some stomachic and opiate mixture, which affords temporary relief. After this condition has lasted for some months, the length of this period of comparative quiescence being influenced by the seat of the ulceration and the rapidity of its extension, the patient begins to have more burning pain after an evacuation, there is also greater straining, and an increase in the quantity of discharge from the bowel; there is now not so much jelly-like matter, but more pus—more of the coffee-ground discharge and blood. The pain suffered is not very acute, but very wearying; described as like a dull toothache, and it is induced by much standing about and walking. At this stage of the complaint the diarrhœa comes on in the evening as well as the morning, and the patient's health begins to give way, only triflingly so, perhaps, but he is dyspeptic, loses his appetite, and has pain in the rectum during the night, which disturbs his rest; he also has wandering and apparently anomalous pains in the back, hips, down the leg, and sometimes in the penis. There is yet another symptom present in the later stages, marking the existence of some slight contraction of the bowel, viz. alternating attacks of diarrhœa and constipation, and during the attacks of diarrhœa, the patient passes a very large quantity of fæces. These seizures are attended with severe colicky pains in the abdomen, faintness, and not infrequently sickness.

‘ On examining these cases of ulceration, various conditions may be noticed according to the stage to which the disease

has advanced. In the earlier period you may often feel an ulcer situated dorsally about an inch and a half from the anus, oval in form, perhaps an inch long by half an inch wide, surrounded by a raised and sometimes hard edge; there is acute pain caused on touching it, and it may be readily made to bleed. With a speculum you can distinctly see the ulcer, the edges well marked, the base greyish or very red and inflamed-looking, the surrounding mucous membrane being probably healthy; in the neighbourhood of the ulcer may often be felt some lumps, which are either gummata or enlarged rectal glands. This is the stage in which the disease is often curable. . . . Later in the progress of the malady you will observe deep ulcers with great thickening of the mucous membrane, often also roughening to a considerable extent, as though the mucous membrane had been stripped off. At this stage you generally notice, outside the anus, swollen and tender flaps of skin, shiny, and covered with an ichorous discharge; these flaps are commonly club-shaped, and are met with also in malignant disease; but in the early development of the disease *no ulceration is found near the anus nor at the aperture*. . . . So definite is this external appearance in long-standing disease, that one glance is sufficient to enable an expert to predicate the existence of either cancer or severe ulceration; these external enlargements are the result of the ulceration going on in the bowel, and the irritation caused by almost constant discharge.'

The imperceptible way in which severe ulceration may pass on to stricture produces a train of symptoms which gradually point more prominently to the existence of the latter than to that of the former. It must further be remembered that, as ulceration proceeds, symptoms may appear, due not directly to the ulcer nor to the resulting stricture, but to other complications, to which either has given origin.

**Treatment.**—In most cases both local and constitutional treatment is required. As regards constitutional, this has reference more particularly to tubercular and syphilitic ulceration, and the special remedies and measures usually employed in these diseases must be used.

As regards the treatment of the ulcer, the patient should be kept as much as possible in the recumbent position, with

the bed or couch raised at the foot, so as to relieve the congestion of the bowel.

Where there is a tendency to constipation, laxatives should be administered.

When it is necessary to deal directly with the ulcer, either stimulants, astringents, or sedative applications may be required.

When the ulcer, from its chronicity or sluggishness, needs stimulating, hot water may be injected; or, as Mathews<sup>1</sup> recommends, pure carbolic acid can be applied. In using the latter, care must be taken to guard the skin and mucous membrane around. The insufflation of iodoform is also strongly recommended by the same author.

To produce an astringent effect, a solution of nitrate of silver, two grains to the ounce or stronger, may be applied. When much pain exists, either opium or cocaine may be used. Cripps<sup>2</sup> recommends an ounce of warm thin starch containing twenty drops of liquor opii sedativi injected by a soft tube well up the bowel after it has been previously washed out with warm water. Cooper and Edwards<sup>3</sup> recommend the application of cocaine ointment; twenty grains to the ounce.

*Operative measures.*—The simplest operation is that of scraping or scarifying. In some instances scraping is considered advisable in tubercular ulceration; as a rule, however, this kind of ulcer increases or diminishes according to the general state of the patient. If the phthisical condition, which is usually present, improves, the ulcer does so also, and *vice versa*, and to scrape under these circumstances may not better matters. Scarification is best employed when the ulcer presents indurated edges and shows an indisposition to heal.

In cases of inflamed and irritable ulceration, great relief is afforded by division of the external sphincter, the ulcer gains greater rest, and freedom from irritation.

Severer operative measures consist in excising the ulcer or a part of the rectum, or in making a temporary artificial anus in the sigmoid flexure. Lange<sup>4</sup> reports having success-

<sup>1</sup> Page 332.

<sup>2</sup> Page 196.

<sup>3</sup> Page 169.

<sup>4</sup> *Annals of Surgery*, 1893, vol. xvii. p. 325.

fully excised the entire rectum, by the posterior incision, in a case of syphilitic ulceration involving the whole inner surface of the bowel.

---

## CHAPTER LXXII

### NON-MALIGNANT OR CICATRICIAL STRICTURE

No disease of the rectum offers greater difficulties on certain etiological and pathological points than non-malignant stricture. That stricture may result either from cicatrization of an ulcer, or from inflammation of the rectal walls, or from inflammation arising primarily outside the bowel, is sufficiently certain; but the difficulty arises when the question becomes one of determining in any particular and doubtful case which of these processes has led to the contraction. Before discussing these points more fully, there are other features worthy of notice regarding the age and sex of the patients usually affected.

In analysing a table of seventy cases of stricture of the rectum recorded by Allingham, sixty were females and ten males. This is somewhat under the relative proportion given by other statisticians. Thus Poelchen, out of 219 cases of strictures forming ulcers, records 190 as occurring in females, while the sex in four out of the remaining twenty-nine cases is not given.

As regards age, by far the largest proportion occur between the years of 20 and 40. Fifty-six of Allingham's cases<sup>1</sup> occurred during this period; while eleven were over 40 years, the oldest being 80; and only three were under 20, the youngest being 13.

The kind of stricture met with varies. In the larger proportion of the cases the stenosed part is either annular or tubular—that is to say, the canal is obstructed either by a ring-shaped constriction, or it is more or less uniformly narrowed for some distance. In cases of cicatricial stricture following ulceration, the nature of the stenosis necessarily depends upon the shape and extent, both superficially and deeply, of the tissue destroyed. Strictures so formed may

<sup>1</sup> *Diseases of the Rectum and Anus*, p. 230.

exist in the shape of a diaphragm, or as bands crossing in various directions.

Stricture as a sequel to ulceration owes its origin indirectly to the various causes which give rise to the latter. These have been discussed already, and need only be briefly enumerated here. They are traumatism, which may be taken to include direct injuries, impaction of foreign bodies or hardened fæces, operations by the surgeon, and injury occurring during parturition; syphilis, tuberculosis, dysentery, and varicose veins. While these causes are all enumerated, it must not be understood that they imply in any sense a uniform frequency of occurrence. Rather should they be looked upon as possible causes among which syphilis, tuberculosis, and dysentery probably account for the larger proportion.

When the stricture partakes of the tubular character, its origin may be the result of cicatrisation after ulceration, but it seems more probable that it is a sequel to acute or chronic proctitis. The walls of the bowel, especially the submucous and muscular coats, become infiltrated with inflammatory material, which in organising and contracting produces a rigid and resisting fibrous canal. It is the etiology of this particular kind of stricture which has been the subject of so much controversy in past years. The old custom of ascribing it to syphilis, whether there existed other evidences of the disease or not, has frequently been called in question. Not only is the stricture met with in cases where there is not the least evidence of, or any reason to suspect, syphilis, but the lesion itself has no similarity to specific affections in any other part of the body. That syphilis plays some important part in the formation of rectal stricture is acknowledged and sufficiently attested by all statistics. Thus out of Allingham's seventy cases, thirty-five suffered from undeniable constitutional syphilis, and other five had some symptom of it, making a percentage of 50. This ratio, however, is somewhat in excess of that given by others. Thus in Poelchen's series of 219 cases there was a history of syphilis in ninety-six, making a percentage of 43·3; while Cooper and Edwards give the average as from 25 to 30 per cent.

Difficulty, however, is encountered when an attempt is made to define the nature of the initial lesion causing this

form of tubular stenosis. By some it is believed to be due to the healing of a broken-down gumma, against which view, however, it is contended that the natural process of cure in a disintegrated gumma is not by a contracting cicatrix, but by atrophic changes in the tissues concerned. Others believe that in the late stage of the disease an infiltration of the muscular coat with small round cells takes place. These, by organising, lead to the formation of fibrous tissue, which, in contracting, causes atrophy of the muscular fibres and a narrowing and induration of the canal. To discuss this interesting subject further, would carry me beyond the limits of the space at my disposal. Those therefore who would like to pursue it, I would recommend to consult such an excellent authority as Kelsey, who has devoted much thought and attention to it.

Among external causes which give rise to stricture, the injury resulting from parturition occupies a prominent place. Its influence in producing injury, sometimes of an extensive and serious kind, has been mentioned already.

**Pathological sequences.**—The results accruing from stricture of the rectum are much the same as those occurring in stricture in other parts of the intestinal canal, modified only by the anatomical relations of the region. One of the earliest changes to take place as the canal narrows is its dilatation above the obstruction. This is accompanied also with some hypertrophy of the muscular coat and thickening of the mucous membrane. As the dilatation advances, its presence may become manifest by a generally distended condition of the abdomen. The irritation to which the mucous membrane above the stricture is exposed by the retained feces leads to a variable amount of inflammation and ulceration. This process may extend to the peritoneum and cause a chronic form of localised peritonitis ; or, if ulceration advances, abscess in the surrounding tissues may form and burst either into the rectum below the stricture, or find its way into the ischio-rectal fossa, where, by opening externally, it gives rise to one form of fistula *in ano*. Communication may also be established between the vagina, uterus, bladder, or urethra from the ulceration advancing, or the abscess bursting, into these parts.

Below the stricture, changes are also met with in the bowel wall. It is frequently noted that the cavity of the bowel is unusually large, this condition being technically described as 'ballooning.' The mucous membrane is often ulcerated and the hæmorrhoidal veins distended. The nearer the stricture is to the anus, the more is the anal aperture likely to be involved in other changes. In severe cases it becomes patulous, with protrusion of the mucous membrane from the orifice, which sometimes amounts to actual prolapse of the bowel. The frequent discharge of purulent material causes troublesome eczematous eruptions and excoriations of the skin around the anus.

**Symptoms.**—In cases of stricture following ulceration, there is usually the history of symptoms of variable duration and severity connected with the latter; and when stricture is the result of such constitutional affections as tuberculosis, syphilis, and dysentery, there is also either existing or past evidence of such diseases.

The lesion itself, when at a more or less advanced stage, usually gives rise to a fairly typical train of symptoms. One of the earliest and most troublesome of these is that connected with the increasing obstruction to the normal passage of the fæces. The patient finds that he is unable to get a movement of the bowel without taking an aperient. This perpetual retention of the fæces above the constricted part soon gives rise to additional troubles. The irritation of the mucous membrane causes inflammation and ulceration, with a frequent discharge of blood and pus. The patient is thus frequently induced to go to stool, but the straining efforts induced lead to little more than the ejection of the inflammatory exudation. When fæces are passed, they may be in small fragments, scybalous, flattened, or attenuated, their conformation depending principally upon the tightness and situation of the stricture. Thus, when situated high up, an accumulation may take place in the lower dilated portion of the rectum, before evacuation follows.

The more persistent and obstructive the disease the severer become the symptoms, both general and local. The patient suffers from increasing distension of the abdomen, due to the accumulation of fæces within the colon and to the

development of flatus. The stomach becomes deranged, so that there is often nausea and distaste for food. Emaciation soon follows, with pallor of skin and derangement of the nervous system; the latter showing itself in sleeplessness and mental depression. Without relief, the patient dies of exhaustion unless carried off by some intercurrent complication, such as acute intestinal obstruction or peritonitis.

The amount of pain suffered varies. When severe it is felt not only in the part, but at the back of the sacral region, in the abdomen, and down the thighs. As complications appear, such as abscess formation, feverish symptoms arise, which more or less disappear on the bursting or evacuation of the purulent collection; other symptoms, however, may then arise dependent upon the creation of fistulous communications either with the exterior of the body, or with some viscus internally. The onset of acute intestinal obstruction or acute peritonitis will be indicated by the symptoms usually significant of those conditions.

**Diagnosis.**—While the symptoms narrated above may lead to a strong suspicion of stricture, it is not until a careful examination has been carried out either by the finger or the bougie that a certain diagnosis can be made.

For all strictures situated within the lower four inches of the rectum, digital examination is sufficient; but for those higher up, one of three means must be adopted: either the whole hand must be inserted, or the rectum be distended with fluid, or a bougie passed.

For using the hand for purposes of diagnosis, see p. 566.

Injections are sometimes serviceable when conducted in conjunction with auscultation and palpation of the sigmoid flexure. The observation is conducted with the object of determining the quantity of fluid which can be injected, and whether or not it passes upwards into the large intestine. The method is helpful, but not certain, since it is open to the objection that the fluid may pass through the stricture and so mislead.

The bougie, next to the hand, affords the most reliable information. It has, however, to be used with care; and is open to the objection that it may mislead by being obstructed in its course by a fold of mucous membrane, or by impinging upon the sacrum.



Three kinds of bougies are used, both for purposes of diagnosis and for treatment. These are represented by figs. 100-102.

Of these, the one with the olive-shaped ivory head and flexible shaft is best for diagnostic purposes. Not only does it render certain the existence of a stricture, but it affords a



FIG. 100.—ROUND-SHAPED BOUGIE



FIG. 101.—CONICAL-SHAPED BOUGIE

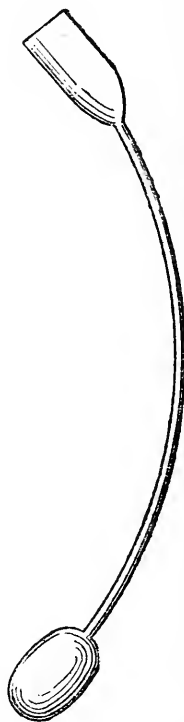

FIG. 102.—OLIVE-SHAPED IVORY-HEAD BOUGIE

FIGS. 100-102.—RECTAL BOUGIES. About half natural size

means of determining its length. When the 'olive' has passed through the stricture, the shaft is felt to slip easily backwards and forwards; but on withdrawal, it is at once detected when the 'olive' re-enters the proximal part of the obstruction, and the grip remains obvious until it is disengaged and enters the dilated bowel below. For directions regarding the passage of bougies, see Operations upon the

Rectum (Chapter LXXXII). It may be incidentally noted here that the use of a bougie for diagnostic purposes must always be gone about with great care, as the bowel wall may be injured to the extent even of fatal perforation.

The true nature of a stricture as to its resistance and resiliency can only be ascertained by the finger. In very tight and hard strictures it is impossible sometimes to insert even the tip of the finger, much less to be able to pass it through.

As a further mechanical aid to diagnosis, the speculum may be used.

One symptom which has been mentioned, and which is considered of special value in the diagnosis of stricture high up, is that of so-called 'ballooning of the rectum.' The condition of expansion or dilatation of the bowel below the stricture has long been recognised, but it is due to Thomas Bryant<sup>1</sup> more particularly that it has come to occupy a recognised place among the important symptoms. By Bryant the condition is considered almost pathognomonic of stenosis, either innocent or malignant, which has been of slow and not rapid formation. The dilatation is supposed to be primarily due to a partial paralysis of the muscular coat, induced by the interference with normal peristalsis by the stricture; and secondarily to distension of the part by gas and fæces.

This symptom, however, cannot, in the light which further investigation has thrown upon it, be considered exclusively distinctive of this kind of disease. Burghard,<sup>2</sup> out of an examination of 200 patients, found ballooning of the rectum to exist under three different circumstances. First, in cases of stricture of the rectum and sigmoid flexure; second, in chronic constipation and fæcal obstruction; and third, in spinal disease. It was never found when the stricture was situated above the lower end of the descending colon.

**Prognosis.**—Stricture of the rectum is incurable, in the sense that, while a patient may be relieved for a variable period, the tendency to recurrence remains a possibility throughout life. If any exceptions can be found to this rule, they are among those cases which have been treated by

<sup>1</sup> *Lancet*, 1889, vol. i. p. 8.

<sup>2</sup> *Ibid.* 1890, vol. ii. p. 92.

successful excision or by linear proctotomy. The most intractable forms to deal with are those where the bowel is uniformly contracted for a considerable extent. Relief may always be temporarily, if not permanently, afforded; but only at the expense of sacrificing the natural ways of defecation for artificial.

In slighter cases the regular and intermittent use of bougies may maintain a normal passage for an indefinite period, the patient in many cases being able to enjoy life for so long as it lasts. No kind of stricture is amenable to curative treatment other than that which may be considered of an operative character.

CASE CVIII.—*Non-malignant stricture of the rectum: linear proctotomy. Recovery.*

A man aged 23 years had suffered from syphilis for five years; he was pallid and emaciated, and complained of the greatest difficulty in defecation. He had a continuous discharge of bloody mucus from the anus. Digital examination showed a ring of ulceration round the entire circumference of the gut, most marked in front, and immediately above the ulcerated surface a tight stricture was to be felt; the tip of the index finger would not pass into it, and it felt hard and rigid. Attempts to dilate with bougies gave rise to great irritation, and rather aggravated his condition. His abdomen became distended, and he had some vomiting. Linear proctotomy was performed. The relief of the symptoms was immediate, and a good recovery followed. When seen eighteen months after the operation, his defecation was normal, except that a slight amount of incontinence occurred when he had an attack of diarrhœa. There was no indication of any recurrence of the stricture, and he was quite strong in health. (Charles B. Ball, 'Trans. of the Royal Academy of Medicine in Ireland,' 1889, vol. vii. p. 184.)

**Treatment.**—Independently of treatment applied directly to the stricture, much relief may be afforded, especially in the earlier stages of the disease, by careful attention to the diet and the condition of the bowels. Food of a rich and indigestible nature is liable to prove irritating to the bowel; a diet therefore as simple and nutritious as possible should be given.

To keep the motions loose a mild laxative should be administered, and when much difficulty exists in obtaining a movement, a slowly introduced enema may effect the desired result.

All measures, however, to deal with the stricture, or with

the obstruction to which it has given rise, must be of an operative nature. The following methods are employed :

1. Dilatation by bougies, tents, and dilators.
2. Electrolysis.
3. Internal proctotomy.
4. External or linear proctotomy.
5. Proctectomy.
6. Inguinal or lumbar anus.

The selection of any one of these methods depends entirely upon the nature of the stricture and the surgeon's aim in treating it.

1. *Treatment by bougies.*—Only strictures of a limited and not very severe type can be thus treated. The dilatation is effected by the daily, or less frequent, passage of bougies of increasing calibre. The good obtained is only temporary, and to be of any permanent value, must be continued indefinitely at variable intervals, determined chiefly by the tendency which the stricture shows to contract. (For passage of bougies, see Operations upon the Rectum, Chapter LXXXIII.)

The good effects exercised by the pressure of a bougie retained for some time within the stricture has induced Credé<sup>1</sup> to devise a shape which could be kept in position with a minimum degree of discomfort to the patient. The instrument is shown in fig. 103. It is made in four sizes. Its chief advantage is supposed to be in the narrowness of the part which rests within the anus, thus causing less dilatation and consequently less discomfort and pain. The bougies can be retained for

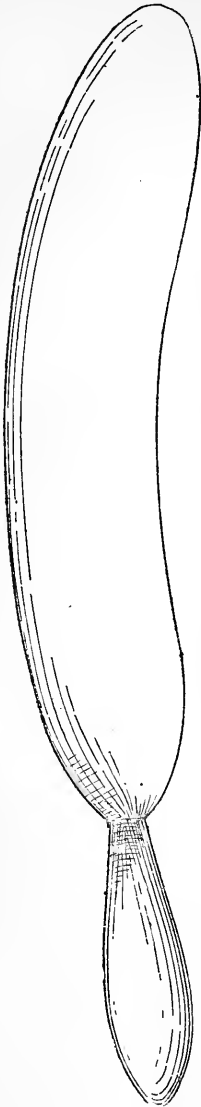

FIG. 103. — CREDE'S  
RECTAL BOUGIE.  
Natural size, No. 20

<sup>1</sup> *Archiv für klin. Chir.* 1892, vol. xliii. p. 175.

periods varying from half an hour to several hours, once or twice daily.

2. *Treatment by electrolysis.*—The success which first attended the treatment of urethral stricture by electrolysis led to its employment in rectal disease. It has not, however, been so uniformly successful that the treatment has received any very large or general application. Isolated cases of cure are recorded. Thus Whitmore<sup>1</sup> is reported to have had admirable results in relieving several cases which had been more or less intractable to the ordinary methods of dilatation. In one of these cases the time taken for treatment extended over three months. In a case reported by Earle,<sup>2</sup> a stricture, which would only admit a silver probe, had existed for several years; it had been unsuccessfully treated by linear proctotomy, but yielded to treatment by electrolysis. The cathode of a galvanic battery was placed within the stricture, while the anode was placed upon the abdomen. The treatment occupied eight sittings, at one week apart, and for fifteen minutes at each sitting. At the end of the period a bougie could be passed which was two inches in circumference.

Robert Newman,<sup>3</sup> with an experience of fourteen cases treated by electrolysis, 'found that the best results in the treatment of rectal strictures were obtained from the use of the same method as would be employed in the treatment of urethral strictures, except that a stronger current may be used, and the sittings may be more frequent. While in the urethra 5 milliampères would be sufficient, 15 milliampères may be used in the rectum. The treatment may last fifteen or twenty minutes, and the sitting should be once in every four days.'

3. *Treatment by internal proctotomy.*—The division of a stricture from within has its advocates, and has had its successes; but the operation has always one serious danger. The incision into the tissues allows of the septic infection of the wound by the fæces, and this may lead to troublesome inflammatory complications. In place of one incision right through the stricture, it is sometimes cut in more than one place. The treatment necessitates for its completion the

<sup>1</sup> *Annual of the Universal Medical Sciences*, 1888, vol. v. p. 61.

<sup>2</sup> *Ibid.* 1889, vol. v. D-14.

<sup>3</sup> *Ibid.* 1891, vol. v. C-25.

subsequent passage of bougies, which must be continued indefinitely if recontraction is to be prevented.

4. *Treatment by external or linear proctotomy.*—This operation consists in entire division of the stricture and all the parts, including the sphincters, from the tip of the coccyx backwards and downwards. It is employed in cases of severe tubular stricture, where the question becomes one of attempting excision or making an artificial anus. The great advantages of this operation are the immediate relief given to all obstructive symptoms, and the complete drainage afforded. As regards results of the operation, it probably affords the nearest approach of any method to a complete cure. Some cases will not succeed without the subsequent employment of the bougie, and even with this failure occasionally occurs. In speaking of a cure, no case should be considered as such unless two years at least of freedom from obstruction have elapsed since the operation.

5. *Treatment by excision.*—While this is the most serious of all the operations, it at least aims at being radical. Its two great risks, which almost amount to prohibitive objections, are that should union by granulation of the divided ends of the bowel take place, there is still the grave possibility of another stricture forming as the result of the operation; and should union prove still less satisfactory, serious inflammatory complications may arise, or troublesome fæcal fistulæ result. By some, however, a sacral anus is considered even preferable to an inguinal or lumbar one. When there is reason to believe that the bowel is much dilated above the stricture, the formation of a temporary artificial anus in the groin will serve the double purpose of giving the distended portion some little time to contract before attempting excision, and remove the irritating and septic effect of the passage of the fæces past the line of union after the operation. When primary union of the divided ends takes place, a practically ideal result is obtained.

Herczel<sup>1</sup> removed a syphilitic stricture measuring 7½ ctms. in length. Owing to sudden collapse of the patient, the operation had to be hurriedly concluded by stitching the proximal end to the skin, thus forming a sacral anus.

<sup>1</sup> *Wiener med. Wochenschrift*, 1892, vol. xlii. p. 1081.

The case did well, and the patient was dismissed from the hospital two months after the operation, free from pain and with one normal daily evacuation. This author refers to two other cases of excision by the sacral method by Richelot and Ferrier, where an excellent result was obtained.

6. *Artificial anus*.—This is formed either in the left inguinal or left lumbar region. When symptoms of acute obstruction are present, the operation becomes an imperative one; but, short of such acuteness, the choice of treatment usually lies between this operation and external proctotomy.

With an artificial anus the patient must be prepared to go through the rest of his life with the inconvenience necessarily attached to such an outlet. With proper regulation of the bowels, however, and due attention to cleanliness, it is possible to reduce the discomforts to a minimum; and it is asserted by such experienced surgeons as Thomas Bryant, William Allingham, and Kelsey, who favour and frequently practise the operation, that not only is the immediate relief great, but the patient's future life may be one of perfect comfort and enjoyment. There is this advantage about an artificial anus, that it carries the assurance that so far as the stricture is concerned, and the kind of suffering which the patient has endured, there need be no more trouble or anxiety.

---

## CHAPTER LXXIII

### TUMOURS: INNOCENT. POLYPUS

THE rectum is liable to be the seat of various kinds of innocent tumours, which vary in their relative frequency. While differing in structure and in the tissues from which they take their origin, there is a remarkable uniformity in the shape and form which they sooner or later assume. With very few exceptions a tumour developing in or from the wall of the rectum soon becomes a more or less pedunculated growth projecting into the bowel and attached to it by a pedicle which may be long and narrow, or short and broad. This peculiar feature, which has caused these growths to be generically spoken of as polypi, probably owes its origin to the mechanical effect of an intermittent *vis a tergo*. Every time

defecation takes place, the growth is pressed upon from above by the descending solid matters; and when once this effect has been produced, it doubtless becomes added to by the natural expulsive efforts of the bowel to rid itself of what it interprets as the presence of foreign matter.

There is another feature worthy of note in connection with these so-called innocent tumours, and that is, that the line of separation between them and malignant growths is not always a very clear and decided one. The subject will be alluded to again, when discussing particular forms of the disease; but the fact is referred to here, so that the preliminary assumption may not be made that every tumour now to be described is necessarily of a purely innocent nature—that is to say, that its removal necessarily implies its non-recurrence and non-extension.

The innocent tumours met with in the rectum are *adenomata*, *fibromata*, *papillomata*, *lymphomata*, *myomata*, *myxomata*, *lipomata*, *cystomata*, *teratomata*, and *angiomata*.

**Adenomata.**—By far the largest number of innocent tumours met with are comprised in the class of adenomata. As most frequently met with, they are single tumours, soft in texture, vascular, attached by a narrow pedicle to the rectal wall, and occurring more often in the young than in adults. In size they may vary from a pea to a walnut, and in one typical form they resemble in appearance a raspberry. When the stalk is sufficiently long, or the tumour is attached near the anus, they may project into or through the orifice. When examined microscopically, they are found to be purely glandular in structure, the glands resembling those of other parts of the mucous membrane, except that they show much irregularity in their disposition, and considerable differences in size. Blood vessels pass through the pedicle to and from the body of the tumour; and when the arteries are of any size their pulsation can be easily felt. While this form of polypus is most frequently met with singly, exceptional instances occur where they are disseminated or multiple. These are more fully referred to below.

The extraordinary resemblance which exists between the microscopic characters of these so-called innocent glandular polypi and the malignant columnar-celled carcinoma or



adenoid cancers naturally raises the question as to the possibility of any connection existing between the two. Histologically the one grows out from the wall of the bowel, while the other grows into it; but it is probable that some more cogent factor is at work determining the peculiar invading features of the one than is simply represented by what otherwise appears almost accidental. As bearing on this question the following facts are not without interest. In a case reported by Handford, and already quoted in discussing innocent tumours of the large intestine, the transitional stages of an adenoid polypus to a malignant growth could be well observed (see p. 462). In another case, cited by Ball,<sup>1</sup> a glandular polypus was met with in conjunction with a malignant ulcer, the one being situated at some distance from the other. In a case of multiple polypi recorded by T. Smith,<sup>2</sup> a malignant stricture existed at the junction of the sigmoid and rectum.

**Fibromata.**—Tumours of this character are almost as common as those of the preceding variety. Together with them they may be considered as constituting what is specifically and commonly known as polypus of the rectum. In all points except in their intimate structure they resemble the adenoid polypus, being rounded in shape, and attached to the bowel wall by a pedicle of variable length and size. They usually exist singly, but in exceptional instances are multiple (see below). When examined microscopically, they are found to consist of fibrous tissue of varying degrees of density, covered over by normal mucous membrane. A remarkable specimen was shown by Bowlby at the London Pathological Society,<sup>3</sup> of a tumour composed of very loose connective tissue. It was about the size of a foetal head, and weighed two pounds all but an ounce. It was attached to the anterior wall of the rectum of a woman aged 24 years, at a distance of about four inches from the anus.

**Papilloma, or villous tumour.**—This form of tumour is a rare but well-recognised and distinct type of growth. It constitutes one of those forms which occupy the boundary line between what are considered definitely innocent and

<sup>1</sup> *Trans. Royal Academy of Medicine in Ireland*, 1890, vol. viii. p. 414.

<sup>2</sup> *St. Bartholomew's Hospital Reports*, 1887, vol. xxiii. p. 225

<sup>3</sup> *Trans.* 1883, vol. xxxiv. p. 106.

those that are described as distinctly malignant. For while the growth in its initial state seems to lack the features of typical malignancy in not extending beyond its original seat, it does appear to resemble carcinoma in occasionally returning after removal, and then presenting sometimes the characteristics of epithelioma. William Allingham,<sup>1</sup> whose clinical experience and description of the disease are at the same time the most extensive and the best, says that he is 'compelled to express the opinion that they may become malignant, having now seen two cases in which epithelioma replaced the villous growth.'

The comparative rarity of the disease is shown in the fact that throughout Allingham's<sup>2</sup> great experience, only eight cases occurred in his own practice, while he refers to one in the practice of Gowlland, one in Cooper's practice, and two under the care of Goodsall. Cooper and Edwards<sup>3</sup> give eight cases as being admitted to St. Mark's Hospital during fifteen years; seven were males, and one a female. These cases, however, probably include those recorded by Allingham; but Edwards<sup>4</sup> records at length a case of his own, where there were two tumours, the one pedunculated and the size of a hen's egg, situated just inside the anus on the anterior wall of the gut, and the other somewhat smaller, sessile and situated higher up the rectum. Mathews<sup>5</sup> speaks of having seen only one case in fifteen years, but refers to cases recorded by van Buren, Goselin, Bryant, and Cook in addition to those quoted above. Cripps<sup>6</sup> records in full two cases seen by him. Bowlby<sup>7</sup> reports a somewhat unusual case of a diffuse papillomatous growth, which does not, however, appear to belong to the class here described. The growth occurred in an Arab lad aged 17 years, and was composed of loose fibrous tissue, rich in cells, apparently of inflammatory origin, in the meshes of which were large numbers of the ova of Bilharzia. Sheild's case recorded below, serves to illustrate the symptoms usually met with in villous tumours, although they are possibly of a somewhat exaggerated type.

The papillomata are frequently pedunculated, but as fre-

<sup>1</sup> Page 317.

<sup>2</sup> Page 316.

<sup>3</sup> Page 247.

<sup>4</sup> Page 251.

<sup>5</sup> Page 515.

<sup>6</sup> Page 285.

<sup>7</sup> *Trans. Path. Soc. Lond.* 1891, vol. xlii. p. 136.

quently sessile. In the former case the peduncle is usually broader than in the more commonly met with adenoid or fibrous polypus. In their minute structure they resemble the adenomata, but present a more irregular surface than the latter, being 'composed of compactly applied, various shapen processes, sometimes dendritic, at others flat and leafy, and comparatively simple in form' (Shattock). They are very vascular, and prone to bleed, large quantities of blood being sometimes lost. As another distinguishing feature from the common form of polypus, they are only met with in adults, and not infrequently in old people.

CASE CIX.—*Papilloma or villous tumour of the rectum.*

A woman aged 42 years had suffered for eight years with rectal symptoms. Hæmorrhage was constant, so that a condition of anæmia was produced; and sometimes profuse bleedings occurred, reducing the patient to great prostration. Abundance of offensive and tenacious mucus issued from the anus. The presence of the growth impeded defecation, and it afterwards protruded from the anus. On several occasions it had become strangulated, causing much pain and difficulty of reduction.

In the recent state the tumour was the size of a small orange, and attached by a thick but soft pedicle of about an inch in length to the mucous membrane of the rectum, about an inch and a half from the anus on the dorsal aspect of the gut. It was dark in colour, lobulated, and foliaceous; the surface soft and lacerable, in consistence resembling in appearance a portion of pancreas or salivary gland. One of the club-shaped processes was examined microscopically, and found to consist of glandular and fibrous tissue with a covering of columnar epithelium. (A. Marmaduke Sheild, 'Trans. Path. Soc. Lond.' 1888, vol. xxxix. p. 130.)

**Multiple polypi.**—All three of the preceding varieties of growths, as also that of the variety which immediately follows, may be met with as more or less disseminated or multiple tumours throughout the rectum. The two former, however—the adenoid and the fibrous—constitute those most frequently met with. The disease is a rare one, but numerous cases are recorded. Why the wall of the rectum should thus become converted into a surface having numerous pendulous projections hanging from it, it is not possible to say; but in these extreme cases it frequently happens that not only is the rectum involved, but the diseased condition extends up into the large bowel above. There is reason to suppose that the disease is in some sense constitutional, for in a case reported

by Bickersteth<sup>1</sup> of a child aged 11 years, the mother had also suffered from a similar condition; and in another case, reported by T. Smith,<sup>2</sup> three members of the same family were all exactly similarly affected.

In most of the recorded cases it would appear that the disease is most frequently met with at the earlier period of life. In two cases recorded by Cripps,<sup>3</sup> the ages were respectively 19 and 17. In a case reported by Dunn,<sup>4</sup> the boy was aged 10. In another case, by Shattock,<sup>5</sup> in which the polypi were composed exclusively of lymphatic tissue, the boy was aged 4½. In Bickersteth's case the child was 11 years old.

**Lymphomata.**—It occasionally, though rarely, happens that what is clinically diagnosed as a common adenoid or fibrous polypus, turns out on microscopical examination to be composed entirely of lymphatic tissue. Ball<sup>6</sup> describes a polypus which with another formed the apex of a prolapse in a boy aged 6 years; on microscopic examination both tumours were found to consist solely of lymphatic tissue. Shattock's case of multiple polypi above alluded to consisted of numerous sessile growths, all exclusively composed of the same lymphoid tissue. In these cases it is probable that the polypi have their origin in the solitary glands of the mucous membrane.

**Myomata.**—Tumours developing in the muscular coat of the bowel, and composed either wholly of muscle, or of this in combination with fibrous tissue, are sometimes met with. McCosh<sup>7</sup> records the case of a man aged 34 years, who for some years had had increasing difficulty in obtaining evacuation of the bowels. Latterly the only faecal matter which he had been able to pass was thin and ribbon-like. On examination of the rectum a tumour was found in the posterior wall, extending up from just above the anus to the hollow of the sacrum. The tumour was removed, and found to be the size and very much the shape of a large cocoanut. It was examined and declared to be a fibro-myoma, springing from the muscular coat of the rectum. Ball<sup>8</sup> also refers to a case

<sup>1</sup> *St. Bartholomew's Hospital Reports*, 1890, vol. xxvi. p. 299.

<sup>2</sup> *Ibid.* 1887, vol. xxiii. p. 225.

<sup>3</sup> Page 276.

<sup>4</sup> *Trans. Path. Soc. Lond.* 1890, vol. xli. p. 139.

<sup>5</sup> *Ibid.* p. 137.

<sup>6</sup> *Trans. Royal Academy of Medicine in Ireland*, 1890, vol. viii. p. 415.

<sup>7</sup> *Annals of Surgery*, 1893, vol. xviii. p. 41.

<sup>8</sup> *Trans. Royal Academy of Medicine in Ireland*, 1890, vol. viii. p. 415.

of Macan's, where a myoma was enucleated from the wall of the rectum.

**Myxomata.**—Tumours of this character—as indeed most, if not all, of those which follow—are of the nature of curiosities rather than otherwise, so rarely are they encountered in practice. A tumour of this particular character occurred in a woman aged 63 years. The case is reported by Jones,<sup>1</sup> who states that the patient had complained for two years of symptoms resembling those of chronic dysentery: her motions were frequent, but nothing except a little blood and slime passed. Examination revealed a rounded growth lying high up between the rectum and the vagina. After removal it was found to consist of three separate tumours, the largest being about the size of a pullet's egg; the other two were much smaller. The microscope showed characters of a myxoma.

**Lipomata.**—Fatty tumours, when met with, arise from the submucous tissue. In a case recorded by Voss,<sup>2</sup> and which by some is quoted in illustration of a fatty tumour in this region, the growth appears to have had its origin in the sigmoid flexure, and merely descended into the rectum. The author, however, refers to two other cases, one by Holst and another by Coupland.

**Cystomata.**—In illustration of cystic tumours the following two cases may be instanced. One recorded by Prideaux,<sup>3</sup> of a woman aged 28 years, in whom parturition was complicated by a tumour about the size of a foetal head, attached by a long pedicle to the upper part of the rectum. She had suffered for years from obstinate constipation. After removal the tumour was found to contain about half a pint of thick albuminous fluid, with one part a little thicker than the rest. Another case of a very similar character occurred in the practice of Adams and Parsons Smith.<sup>4</sup> After a normal parturition, the patient, a woman aged 30, was found to have a 'thin, pedunculated, pyriform, semi-transparent cyst,' about the size of a foetal head, hanging from the rectum. The cyst was tapped, and eight ounces of straw-coloured fluid drawn off; after which it was found possible to return it.

<sup>1</sup> *Lancet*, 1887, vol. ii. p. 956.

<sup>2</sup> *London Medical Record*, 1881, p. 200.

<sup>3</sup> *Lancet*, 1883, vol. ii. p. 633.

<sup>4</sup> *Ibid.* p. 881.

**Teratomata.**—Dermoid tumours of the rectum have been met with, but from the few cases recorded they must be of great rarity. Port<sup>1</sup> reports the case of a girl aged 16 years, who for three months had had great difficulty and forcing pain in passing her motions. A tumour was noticed to project partly from the anus with a mass of long hair attached to it. When the growth was removed, it was found to be connected by two pedicles to the posterior wall of the gut, about three inches from the anus. It was composed mostly of fibrous tissue with numerous fat cells, and contained two masses of bony substance and a canine tooth. The covering of the tumour consisted of true skin. In a case reported by Danzel,<sup>2</sup> a woman aged 25 years complained of the projection from her anus, after defecation, of long hairs which interfered with her cleanliness, and necessitated her pulling them out. They, however, always grew again, and she eventually sought to have her trouble remedied. On examination with the finger, guided by the tuft of hair, a hard tumour about the size of an apple was felt about two and a half inches up from the anus, on the anterior wall of the gut. It was removed, and found to represent a true dermoid, containing three spicules of bone, some fat, a tooth, and nerve tissue, with a covering of true skin.

**Angieomata or nævus.**—A remarkable example of this type of growth has been recorded by E. J. Barker.<sup>3</sup> The patient was a man, whose first symptom was an attack of diarrhœa, accompanied by great loss of blood. He usually suffered from constipation, and was obliged to strain much during defecation. Sometimes, however, he had intervals of diarrhœa, always with great loss of blood. He felt no pain, did not lose flesh, and had no particular discharge from the rectum, except during attacks of bleeding. On examining the rectum with a vaginal speculum and with artificial light, a mottling was observed with a peculiar purplish tint. Three shallow ulcers were seen, from which blood freely flowed. He gradually sank from loss of blood. At the post mortem the wall of the rectum was found to be much thickened in

<sup>1</sup> *Trans. Path. Soc. Lond.* 1880, vol. xxxi. p. 307.

<sup>2</sup> *Archiv für klin. Chir.* 1874, p. 442.

<sup>3</sup> *Lancet*, 1883, vol. i. p. 637.

the lower four inches and a half of its length by nævoid growth in its walls, on the rugæ of which three ulcers were seen during life.

In connection with this case Howard Marsh also refers to the case of a girl aged 10 years, who for eight years had suffered from repeated and sometimes severe hæmorrhage from the bowels. A nævoid growth was detected in the lower part of the bowel and completely surrounding it. The symptoms were relieved by several applications of Paquelin's cautery, but the disease was not cured.

**Symptoms.**—In most cases the symptoms associated with an innocent tumour in the rectum are dependent upon the particular configuration of the growth rather than upon its histology; that is to say, a tumour hanging by a pedicle, in other words a polypus, will produce symptoms much the same whether it be composed of glandular tissue, fibrous tissue, lymphatic tissue, or any one of the other connective tissues. The same may be said of tumours which do not become pendulous, but which project into the canal and cause mechanical obstruction.

The presence of a polypus in the rectum is usually manifested by frequent discharges of mucus, usually of thin consistency and often fetid, and by the occasional escape of blood. When the pedicle of the polypus is long, the body of the tumour is sometimes extruded from the anus, and if sufficiently tightly constricted it becomes congested, or may get severed from its attachment. The larger the size of the polypus the more apt it is to create a feeling of discomfort within the bowel, and to cause the sensation of imperfect evacuation after defecation. A remarkable and exceptional illustration of the absence of symptoms in the presence of a very large polypus existed in Bowlby's case above referred to. Notwithstanding the enormous size of the tumour—'as large as a foetal head'—the patient had no symptoms until the polypus came down one day when straining at stool, and, its reduction not being possible, it had to be removed.

As a rule, however, the symptoms are dependent upon the size of the tumour, its vascularity, and the extent of the mucous membrane involved. Thus it usually happens that

the villous growth, which is very vascular, and exposes by its irregular papillomatous surface a large extent of secreting mucous membrane, causes more bleeding and more mucous discharge than is met with in the adenoid or fibrous polypus. The case already detailed (Case CIX.) shows how large a quantity of blood may be lost with this kind of tumour. The amount of mucus discharged is sometimes seen by the inability of the patient to prevent a constant leakage through the anus when moving about in the erect position.

In many instances tumours growing from the rectal wall and projecting into the lumen of the bowel cause obstruction ; but I have not met with a recorded instance where the symptoms have advanced to the stage of acute intestinal obstruction. Difficulty in defecation was a prominent symptom in Prideaux's case of cystoma and in Port's case of dermoid. In McCosh's case of fibro-myoma, besides great difficulty in getting a movement of the bowel, the fæces when passed were always thin and ribbon-like.

**Diagnosis.**—When the tumour projects from the anus it is liable to be mistaken for piles, but a closer examination will reveal its true nature. There is also a danger of regarding the occasional hæmorrhage as an indication of the same disease, and the mistake may not be discovered until a proper examination is made. The introduction of the speculum will in many cases bring a tumour into view ; but palpation by the finger, when possible, gives the fullest information. In using the finger a systematic examination of the rectum should be made, otherwise the polypus may escape detection. A polypus with a long pedicle may have its body carried upwards out of reach, and this even may be done at the time of inserting the finger. The existence of a cordlike structure will sometimes indicate that the body of the tumour has been thus displaced, and by hooking the finger around it the tumour may be brought within touch. Better information is therefore obtained when withdrawing rather than when inserting the finger. Straining on the part of the patient, or the administration of an enema, will often help to bring down a growth and admit of its being seen or felt.

The base of attachment of the tumour should always be



carefully noted, for the treatment to be subsequently adopted depends upon the breadth of this connection.

**Prognosis.**—The tendency of all polypi is to increase in size, and for the pedicle to increase in length. This elongation of the pedicle sooner or later admits of the extrusion of the body of the tumour through the anus during the act of defecation, and as a result the veins in the pedicle become obstructed. The tumour then becomes swollen and congested, and if much enlarged is prevented from being reduced within the bowel. A tumour so strangulated is sometimes severed from its connection, and a natural cure results. Allingham believes that villous tumours at times shed themselves, and instances a case in point.

No truly innocent tumour returns after complete removal. The doubtfully innocent nature of villous growths has already been alluded to, and cases cited to show that recurrence has taken place after removal, and that the new growth has manifested the characters of epithelioma.

One of the tendencies of a polypus is to produce prolapse of the bowel; in this the growth exercises a similar action to what occasionally happens in both the large and small intestine. The constant dragging action of the tumour in these latter regions causes intussusception, and cases have already been cited of a polypus in the rectum being found to be the presenting part of a colic intussusception. (See p. 447.)

**Treatment.**—Removal is the only method of successful treatment. In many cases of simple polypus it is easy to pull down the tumour, encircle the pedicle with a ligature, and snip off the mass with a pair of scissors. If the pedicle be long and narrow it may be twisted off with a pair of forceps. The broader the pedicle the greater the care needed in securing it, as vessels of considerable size sometimes pass from the mucous membrane into the body of the growth.

When from the position of the tumour, or the breadth of its basal attachment, it cannot be dealt with simply, the sphincter should be dilated and the base of the growth transfixed with needle and suture. A broad pedicle should

be ligatured preferably in two or more portions rather than encircled by a single thread.

When the pedicle has been tied, the tumour may either be cut away or left to slough off. If there is any risk of much bleeding, it is safer to allow the mass to slough away than to sever its connection at the time of operating, for in the latter case there is a chance of the ligature slipping off the stump.

---

## CHAPTER LXXIV

### TUMOURS (*continued*). MALIGNANT: CARCINOMA AND SARCOMA

OF the two large classes of malignant tumours, the carcinomata and the sarcomata, the former affects the rectum out of all proportion to the latter; while the one is comparatively common, the other is only met with in rare and isolated instances.

**Carcinoma.**—As compared with carcinoma in other parts of the intestine, the rectum is involved, according to Ball,<sup>1</sup> in about 80 per cent. of the entire number of cases.

The disease attacks both males and females, but with a frequency slightly greater in the case of the former. Stierlin<sup>2</sup> gives the following statistics collected by him: Heuck, in a series of 118 cases, gives a ratio of 1·8 male to 1 female; Stierlin with 41 cases, Bryant with 60, and Hildebrand with 187, give a ratio of 2 males to 1 female. As contrasting somewhat with this greater proportion of males to females, Williams, out of a series of 257 cases, found that 130 were males and 127 females; while Kelsey, out of 107 cases, had 50 males and 57 females. In the experience of Allingham and most other surgeons, however, the preponderance of the disease in males is the rule.

As regards age, the disease is essentially one of adult life, and is met with at any period after twenty years. Cases, however, are not wanting to illustrate its appearance in patients under this age. Thus the following are quoted in most of the textbooks: Mayo, a boy aged 12; Gowlland, a

<sup>1</sup> *Trans. of the Royal Academy of Medicine in Ireland*, 1893, vol. xi. p. 166.

<sup>2</sup> *Beiträge zur klin. Chir.* 1889, Bd. v. p. 646.

boy aged 13; Godwin, one aged 15; Quain, one aged 16; Cripps and Allingham, each a boy aged 17; and Schoening two girls, each also aged 17.

**Pathology of rectal carcinoma.**—It was pointed out before discussing the pathology of carcinoma of the large bowel that, prior to speaking of the various kinds of carcinoma which may involve the gut, some definite understanding must be had of the significance of the terms used. The same reasoning equally applies here, and the reader is asked to refer to p. 465 for a description which need not be repeated.

Adopting therefore the threefold classification of carcinoma—the squamous-celled, spheroidal-celled, and columnar-celled—the rectum appears to be affected almost exclusively by the last. In almost every instance where the record of a case carries with it the microscopical description of the growth, the disease is described as of this character. And where such terms as ‘schirrous,’ ‘medullary,’ or ‘encephaloid’ are used they invariably have a clinical, and not a strictly histological, significance; that is to say, the terms are intended to imply either that the tumour tissue is indurated and possibly of slow growth, or that it is soft, pulpy, and probably rapidly growing.

Carcinoma of the rectum, as just indicated, presents many differences in its character. Both as regards its origin and its development marked variations are met with. Why a tumour presenting in its intimate structure such constant uniformity should, in process of development, exhibit such striking differences it is impossible to say. But the reason, whether a constitutional or a local one, is probably the same as that which effects similar modifications in the growth of carcinoma in other parts of the body; and until more is known generally about the etiology of carcinoma, it is impossible to attempt to explain the numerous and variable phases which it presents in its process of development.

In the origin and progress of carcinomatous disease two special forms are described by Cripps:<sup>1</sup> the one known as the ‘laminar’ is characterised by its tendency to spread as a thin layer between the mucous and muscular coats of the bowel; this form finally gives rise to the well-recognised

<sup>1</sup> P. 321.

annular stricture. The other form tends to increase uniformly in all directions both superficially and deeply, and by so doing, to produce a tumour which projects into the bowel; the mucous membrane at an early stage covers the tumour, but sooner or later it gives way, and an ulcerating mass projects which may be as soft as brain tissue.

Of these two types of disease the laminar—or, as it is better known in its more advanced stage, the annular stricture—is the more common. According to Stierlin, 70 per cent. of the cases recorded by him were of this nature, Lövinsohn's series contained 74 per cent., and Heuck gives 76·7 per cent. In Stierlin's remaining cases the disease was distributed about equally on the anterior and posterior walls of the bowel.

Carcinoma is met with in any part of the rectum, but appears to be more frequently seated within the first two or three inches from the anus. In Stierlin's 41 cases the disease was in 28 situated mostly from 3 to 4 ctns. above the anus; in 12 it was seated higher up.

The appearance under the microscope of a section of rectal carcinoma is usually very typical. In general structure it presents the character of a gland, and so constantly is this character present that it has received the name of 'malignant adenoma,' or 'adenoid carcinoma.' A section shows numerous elongated or round tubular structures irregularly disposed and of somewhat unequal calibre. In most sections a uniform layer of columnar-shaped cells is seen lining the tubular or alveolar spaces; it is frequent, however, to see gaps in the lining, due to the dislodgment of cells in the process of mounting. The tubuli and alveoli are filled with cells, but these also are liable to be washed away and leave clear and empty spaces. The relative proportion of cells and intercellular tissue varies, as does also the stage of development or degeneration which each may reach. These variations depend largely upon the rapidity of growth. Thus in a rapidly growing tumour the cells are proportionately more abundant and less typical in character; while the intercellular tissue is less perfectly developed, and often appears as spindle-shaped cells rather than as fibrous tissue. Tumours of this character form what are known clinically as medullary or



PLATE XXVII.



Fig. 104.—COLLOID CARCINOMA OF RECTUM.—The illustration shows a longitudinal section of the rectum with the bladder in front. The wall of the rectum is thickened and infiltrated. (*W.J.M., Glas.*)

encephaloid growths. In a more slowly growing tumour the two primary constituents reach a stage of more perfect development, and the intercellular fully formed fibrous tissue may predominate over the well-defined columnar-shaped cells. In the so-called scirrhus form of the disease, this is the type most usually met with.

*Colloid carcinoma.*—What relation this bears, if any, to the form of carcinoma just described is not definitely known. If it may be looked upon as the result of a degenerative change in the columnar cells of the common adenoid form of the disease, its pathological connection with it becomes at once simplified. Pathologists, however, are not at one on such an explanation, and the disease must therefore for the present be considered separately.

Colloid carcinoma of the rectum is but rarely met with, although undoubted examples of its occurrence are recorded. Allingham<sup>1</sup> mentions having seen many colloid tumours; but his own words which follow seem rather to oppose the view that they were all of the nature of true colloid as here described, for he adds, 'I am not sure that encephaloid may not be colloid or pass into it.' Ball<sup>2</sup> relates having seen two examples, one of which is figured and presents a very typical illustration of the disease. Arnot<sup>3</sup> records an interesting example of the disease in a woman aged 27. The growth almost entirely obliterated the canal and extended to the anus. It there protruded and involved the perineum in one large mass of firm, semi-translucent material. The growth also involved the lymphatic glands in front of the spine and pressed upon the vena cava. In the pelvis it bound together the viscera into a solid mass.

In structure, colloid carcinoma follows the type of the growth as met with in other parts of the body. The stroma, in place of containing typical epithelial cells, is filled with a translucent jellylike material which distends the loculi into spaces of variable size and shape.

*Melanotic carcinoma.*—While many cases are on record of melanotic cancer of the bowel, it is not easy to determine

<sup>1</sup> P. 271.

<sup>2</sup> *Trans. of the Royal Academy of Medicine in Ireland*, 1893, vol. xi. p. 168.

<sup>3</sup> *Trans. Path. Soc. Lond.* 1875, vol. xxvi. p. 122.

whether in all cases this expression indicates a pigmented carcinoma or a pigmented sarcoma. The fact, however, that in nearly every instance where the growth was carefully examined microscopically it was found to be sarcoma renders it probable that a pigmented carcinoma is either never met with or is extremely rare.

*Osteoid carcinoma.*—As this disease, like that just described, is usually indefinitely spoken of as a cancer, it is possible that it too should be considered as of the nature of a sarcoma. The disease, however, is of exceptional rarity, and the only recorded case is that of Wagstaffe,<sup>1</sup> which is found referred to in almost every work on diseases of the rectum.

**Progress of the disease.**—The course which carcinoma pursues resembles that followed by it when occurring in other parts of the alimentary tract, modified only by the special anatomical relations of the region affected. Its progress may be considered from two aspects, the local and the remote.

Locally the disease as it develops affects in the first place the bowel itself, and then, by direct extension, the parts in the immediate neighbourhood.

The manner in which the bowel is affected depends principally upon the nature of the growth. It may block the canal either by projecting into it as a mass of tumour tissue, or by constricting it with a hard and resistant fibrous-like band. When the obstruction is brought about by projecting masses these sooner or later break down, and leave large ulcers, and fungating masses of tissue which frequently bleed freely. When the growth extends backwards into the hollow of the sacrum, it may press upon or invade the sacral plexus, and by so doing be the cause of pain felt in the peripheral distribution of the nerves derived from it. Thus that kind of pain so often described by the patient as like rheumatism or sciatica may owe its existence to some such implication. In the case of stricture, other changes are brought about by the constant and increasing obstruction to the passage downwards of the contents of the bowel above the stricture. These resemble those already described in the case of non-malignant stricture, and consist of dilatation of the bowel above the obstruction, with inflammation and ulceration the result of

<sup>1</sup> *Trans. Path. Soc. Lond.* 1869, vol. xx. p. 176.



constant faecal irritation. Ulceration may take place at any part of the large intestine, and not necessarily immediately above the stricture. If ulceration progresses it may lead to rupture or perforation. In a case reported by Way,<sup>1</sup> a rent admitting the passage of three fingers was found in the caecum, and much faecal matter had escaped into the peritoneal cavity. The accident was ushered in with sudden intense abdominal pain, following upon several months of persistent symptoms of intestinal obstruction. In another case, recorded by Poulton,<sup>2</sup> two perforations of the ascending colon took place just above the caecum. Death occurred from acute peritonitis, and faeces were found in the peritoneal cavity.

Ulceration may also lead to the contraction of adhesions between the rectum and neighbouring viscera, and in this way localised abscesses sometimes form which, bursting into the bladder, urethra, vagina, or uterus, establish fistulous communications. Such results as recto-vesical fistulae are not uncommon, and cause much suffering in micturition. In one of my cases this complication proved the sole source of the patient's suffering, and for it I had to make a sigmoid anus. When ulceration extends into the ischio-rectal fossae, acute inflammation and suppuration follow, with the result that one of the worst forms of fistula *in ano* is caused. In one such case upon which I operated, the patient was admitted into the hospital with extensive acute inflammation commencing in the region of the anus and extending for some distance over both buttocks. When freely incised, a quantity of gas and excessively putrid-smelling faeces escaped, and a large cavity was left with shreddy sloughs adherent to its walls, and laying bare the coccyx.

In rare instances the abscess, instead of bursting externally, reopens into the bowel below the stricture, and thus, as happens in the urethra, a new channel is opened up for the discharge of the hitherto obstructed faeces.

In cases of ring stricture it occasionally happens that the narrowed orifice becomes suddenly blocked, and symptoms of obstruction set in which are not necessarily acute in character, but tend to be so the higher the seat of the obstruction.

<sup>1</sup> *Trans. Path. Soc. Lond.* 1875, vol. xxvi. p. 104.

<sup>2</sup> *Australasian Medical Gazette*, 1894, vol. xiii. p. 84.

Another cause of intestinal obstruction is the formation of a rectal intussusception. The constant efforts on the part of the bowel above to drive on its contents causes the strictured ring to descend ; and, although usually more or less gradual in its process, it may suddenly amount to a complete intussusception, with the result of creating an impervious canal.

The bowel below the seat of obstruction also suffers from changes similar to those described in connection with simple cicatricial stricture. When the disease is situated high up in the rectum, the portion below often becomes 'ballooned,' the cavity of the bowel being markedly expanded, and for the same reason as already explained in discussing the conditions in simple stricture (see p. 596). Internal hæmorrhoids are frequently present ; and when the disease is situated low down, the anus may be invaded or may be patulous and cedematous, and possibly excoriated by the constant escape of putrid and irritating discharges.

In considering the remote changes effected by the progress of the disease, the anatomy of the part must be borne in mind. The fact that carcinoma may be carried into distant parts, both by the lymphatics and by the veins, renders it important to consider the course which these vessels take in their passage from the initial seat of the disease. By reference to the anatomy of the rectum it will be found that the lymphatics from all parts of the rectum above the anus proceed to the sacral glands in the hollow of the sacrum and to the lumbar glands along the sides of the lumbar vertebræ ; while the veins return their blood into the portal vein and into the inferior vena cava. Hence, in seeking to ascertain if the lymphatic glands are enlarged, the sacral glands must be examined through the posterior wall of the rectum and the lumbar glands by pressure exercised through the anterior abdominal wall. These glands sometimes enlarge to the size of a hen's egg or even larger, and can then be easily felt.

In distribution of the disease by the veins, the liver is the first to become involved, and in some instances so markedly does this involvement take place that its large size and nodular and irregular outline constitute a prominent feature in the case. Systemic infection through the vena cava is shown by involvement of the lung and other parts of the body.

A case of secondary infection of the lung was shown at a Branch meeting of the British Medical Association by F. Marsh.<sup>1</sup> Pitts<sup>2</sup> records the case of a spontaneous fracture of the humerus. Amputation of the arm was performed. When the tumour was examined microscopically, it was found to be so perfect in resemblance to the tumour in the rectum that it was impossible to distinguish the one from the other. Marcus<sup>3</sup> is quoted as having reported a case of secondary infection of the brain.

Another effect of the absorption into the blood of substances connected with the growth is the production of a peculiar sallow complexion, the so-called cachexia. This is usually considered a feature of some diagnostic value in all cases of advanced carcinoma, but more particularly is it so in rectal disease.

---

## CHAPTER LXXV

### CARCINOMA (*continued*). SYMPTOMS. DIAGNOSIS. PROGNOSIS REGARDING OPERATIONS

**Symptoms.**—Like most diseases involving the alimentary tract, the early symptoms are often of an extremely vague and uncertain character. It is as a rule not until a comparatively advanced period that symptoms in any degree typical of the disease are present.

As will be gathered from what has been said in connection with the pathology of the disease, there can be no uniformity or constancy in the symptoms manifested. The nature of the growth, its seat and extent, affect as much as anything, the symptoms present; and if to these be added the natural differences of susceptibility which patients exhibit regarding discomforts and pain, it will at once be seen

<sup>1</sup> *Brit. Med. Journ.* 1891, vol. i. p. 857. (In reply to a letter sent in the autumn of 1895, Dr. Marsh informed the author that the patient whom he had exhibited as apparently suffering from lung infection had died with symptoms of increased involvement of the lungs, but that a post mortem had not been obtainable.)

<sup>2</sup> *Trans. Path. Soc. Lond.* 1891, vol. xlii. p. 267.

<sup>3</sup> *Index Medicus*, 1890, p. 67.

how extremely variable must be the symptoms present in each case.

*Constipation and diarrhœa.*—Among the earliest indications of the disease, and more particularly of that form of it which results in the annular or ring stricture, is gradually increasing difficulty in defecation. The onset and progress of the difficulty are naturally very insidious, and it is only when the patient begins to find it needful to render the motions lax by aperients, in order to get a passage, that a suspicion is entertained regarding the possible nature of the complaint. It is often also at this early stage that some little bleeding is frequently noticed; and the patient is misled into the belief that the hæmorrhage is the result of piles. When obstruction has reached a certain stage, a spurious diarrhœa often sets in and the patient is compelled to make frequent efforts to empty the bowel, although little more than some blood-stained mucopurulent material may be discharged.

The *feces* in their character frequently constitute an important diagnostic feature in the disease. When the obstruction is situated low down in the rectum, the motions may be modified in shape. They may be flattened, narrowed like pipe-stems, or grooved. If the obstruction is higher, they may be entirely wanting in form. In most cases where the disease is at all advanced, the motions are loose, and coated or streaked or mixed with blood-stained mucus or possibly with pus. The amount of blood lost varies, but is as a rule small in quantity. The excessively offensive smell of the discharges observed in some cases constitutes almost a pathognomonic sign of carcinoma.

The *pain* felt is extremely variable, both in kind and in intensity. In some cases it is so slight that not until within a short time before death is any complaint made. Unfortunately this complete absence of pain is the exception rather than the rule. Pain of some kind is generally felt throughout the disease, and in many instances it becomes of such a severe and constant character, that there are few troubles which cause more acute suffering. The simplest type of pain is that which consists in little more than a constant feeling of discomfort at not being able to successfully empty the bowel. The existence of ulceration and involvement of nerves probably

accounts for the severer types of pain. The patient complains of a feeling of 'burning,' which is often worse after a movement of the bowels; or there is a constant sensation of weight in the part, with possibly a dull gnawing pain at the back of the sacrum. When the pain is reflected down the legs, it is sometimes described as 'sciatica.' Occasionally pain is complained of in the abdomen.

Other symptoms become manifest as the disease progresses and produces its various complications. The complexion of the patient is frequently markedly sallow; loss of sleep and loss of appetite co exist with loss of flesh and loss of strength. There may be enlargement of the liver, with possibly some irregularity of its edge and surface. Deep palpation of the abdomen, either with or without an anæsthetic, may also reveal the presence of enlarged lymphatic glands. The increasing obstruction may cause distension of the abdomen, and griping pains will indicate the fruitless efforts of the peristaltic wave to overcome the obstruction. If complete blockage of the narrowed channel should take place, symptoms of intestinal obstruction follow. As a rule these are not of the same acute character as when the bowel is obstructed in the colon or small intestine; and may be said to be less severe the lower the disease is situated in the rectum. It is not uncommon for vomiting to continue for several days before it becomes fæcal, and for the patient during this time not to be particularly distressed or put about.

The sudden onset of acute abdominal pain, in a patient not otherwise very ill, must be considered as probably indicating rupture or perforation of the bowel above the obstruction.

**Diagnosis.**—No diagnosis of carcinoma of the rectum can be said to be rendered perfectly certain unless the disease can be either seen or felt. Hence it follows that it is only when it is seated within the lower six inches of the gut that a definite opinion can be expressed. The reason of this arises from the fact that, when a carcinomatous stricture involves the upper part of the rectum, its differential diagnosis from obstruction due to simple stricture is very difficult, and at the most can only be conjectured from such facts as the age of the patient, the length of time the symptoms have

existed, and the general appearances and conditions represented.

When the finger can reach the seat of the disease, what is felt will depend upon the nature and extent of the growth. In any case of doubt it is possible to remove, either with the finger nail or with a pair of forceps, a small piece of the tumour tissue for microscopic examination. When the finger cannot reach the disease, it may be possible to see it with a speculum, and to verify the diagnosis by the removal of a fragment for examination.

Cripps<sup>1</sup> attaches some weight, in distinguishing between an innocent and a malignant stricture, to the condition of the mucous membrane between the anus and the strictured part. In the former the mucous membrane is somewhat hard and contracted, portions of it instead of feeling soft and supple are often hard and creaking, as if replaced by cicatricial tissue; while in the latter the mucous membrane is generally comparatively healthy.

Assistance in the diagnosis of a stricture in the upper part of the rectum may be obtained by the method of injection, by the use of bougies, and by the presence of 'ballooning' of the bowel below. Reference should be made to these diagnostic measures when discussed in connection with non-malignant stricture. It should, however, be briefly repeated here that bougies, if employed at all, must be used with the utmost care; for if there is danger of perforating the bowel in simple stricture, much more is this the case in malignant disease.

**Prognosis.**—The inevitably fatal nature of the disease renders the question of prognosis one dependent upon the relative merits of the different modes of treatment. The question becomes one simply of determining how much longer a patient can live after treatment than if no treatment had been adopted.

As regards length of life independently of treatment of any kind—that is to say, the length of time the disease takes to run its natural course—great differences necessarily exist. For not only are there innumerable variations in the modes of involvement of the bowel, and in the rapidity with which the

<sup>1</sup> P. 369.

growth progresses and implicates other parts, but the greatest possible difficulty exists in fixing the period at which the disease commenced. Cases are recorded where the first symptoms experienced by the patient were those of acute intestinal obstruction—in other words, the patient had lived in apparent health, with little or no indication of the disease which was slowly progressing and shortly to terminate in death. As a rule the younger the patient the more rapid is the progress of the disease; hence in old people we find that life is often much prolonged. It may be approximately said that the patient lives for about a couple of years after the first appearance of the disease as manifested by symptoms. Death then results from exhaustion. Should complications arise they may hasten the end, and if these are of the nature of complete obstruction or perforation a more or less rapidly fatal result ensues. There is, in many instances, little or nothing to guide in reckoning the possible length of life in any particular case, except it be the special nature of the tumour which it is possible either to see or feel.

Prognosis in regard to treatment concerns, in the first place, simply the relief of the patient's symptoms, and, in the second, the possibility of curing the disease.

No subject in surgery has afforded a field for keener conflict than that which concerns the operative treatment of this disease. The contending parties are those who advocate the formation of an artificial anus either in the groin or in the loin, and those who advise radical treatment by extirpation. The aims are totally distinct, and as the means to procure the ends differ so greatly in their nature and severity, it must be clearly shown that the severer measure of extirpation justifies the rejection in certain cases of the comparatively safe and purely palliative operation of making an artificial anus.

In discussing the merits of extirpation, the two primary methods of operating must be considered separately. These methods are the removal of the disease when situated in the lower half of the rectum, by operating through the perineum; and removal of the disease when seated in the upper half, by operating through the sacral region. The greater magnitude

of the latter operation necessarily causes it to rank as the severer method of the two.

In weighing the merits of either of these operations, it must be understood that in both, suitable cases are selected for the treatment. Incomplete removal of the primary seat of the disease in carcinoma, occurring in any part of the body, is invariably followed by conditions worse than those for which the operation was originally performed. This specially applies to disease in the rectum, where the part of the tumour left behind takes on a renewed activity in growth, and re-contraction rapidly follows with a return, in possibly an augmented condition, of the original symptoms. I cannot do better than illustrate by a case the pitiable results that imperfect removal may entail; for if such results are possible it behoves the surgeon to doubly consider the advisability of attempting the extirpation when there is not good reason for assuming the possibility of removing the primary seat of the disease.

CASE CX.—*Illustrating the bad effects of perineal excision of the rectum.*

A woman aged 43 was admitted complaining of loss of blood, from time to time, from the rectum, five inches of which had been removed eighteen months previously for local causes. She had, however, received but little benefit from the operation. Liquid fæces were constantly flowing away. There was great excoriation of the left buttock, and ulceration. The orifice of the rectum was nearly closed by a tight cicatricial stricture, through which the tip of the finger could just pass. There was bleeding after admission into hospital, as much as a pint being lost on two or three occasions. Digital examination of the rectum detected, about three or four inches up, a hard mass at the posterior wall of the gut. (Thomas Bryant, 'Clin. Journ.' 1893, vol. ii. p. 213.)

It might justly be argued in this case that the bad after effects were more due to the inefficient treatment carried out after the operation than to the operation itself; for had dilatation been constantly and carefully maintained, the troubles connected with the stricture might never have been. But that such after care is needed, is a serious objection to the operation, because of the known difficulty which exists in getting patients to persist in carrying it out. I remember making the post mortem upon a man whose rectum had been



excised some months previously; his life latterly became one of such abject misery that he committed suicide.

I will consider first, *prognosis in the perineal operation*, supposing that, as far as possible, suitable cases are selected—that is to say, cases in which, from the locality, mobility, and general nature of the growth, the surgeon believes its total removal from the perineum possible.

Great difficulty attaches to reasoning from statistics; unless the character of each case is clearly reported, there is the great probability that, in many instances, attempts at removal will have been made where the untoward results sufficiently indicate that operation should not have been performed. I have, however, been able to collect statistics from two sources which seem to supply the requisite data. They are those of Cripps of London, and Czerny of Heidelberg, both surgeons of recognised repute, and whose cases are carefully selected.

Cripps<sup>1</sup> excised the rectum from the perineum in 38 cases; 3 died and 35 recovered from the immediate effects of the operation, giving a mortality of 7·8 per cent. The following shows the subsequent history of the cases that recovered:

- In 7 no reliable subsequent history.
- In 10 recurrence occurred within one year.
- In 5 recurrence occurred between the first and third year.
- In 1 death occurred a year later without recurrence.
- In 1 no recurrence after the lapse of eighteen months.

In 11 no recurrence in	{	3 under 1 year
		1 after 2 years
		1 " 3 "
		2 " 4 "
		1 " 5 "
		2 " 6 "
1 " 12 "		

Out of this list of cases there were therefore seven which had lived beyond the usual three-year limit; among these, however, were three in which some recurrence took place, but which in each was successfully removed.

<sup>1</sup> *Brit. Med. Journ.* 1892, vol. i. p. 1277.

Czerny's cases<sup>1</sup> are collected from the six years between 1886 and 1891, and were published by Schmidt in 1892. It is not therefore possible to give the complete number of cases which might pass beyond the three-year limit, nor to state how much longer than the period included any particular case which had passed the cure-limit might live.

These six years embrace thirty-two operations by the perineal method with one death; thus giving a mortality of 3.1 per cent. as directly the result of the operation. At the time at which the report was made there were ten of these patients living.

1 patient	5½	years	after	the	operation
3 patients	5	"	"	"	"
1 patient	3½	"	"	"	"
1	"	1½	year	"	"
2 patients	1	"	"	"	"
1 patient	½	"	"	"	"

Of sixteen cases which had died, the duration of their life after the operation amounted on an average to two years, the longest duration was four years. Nothing was known about four patients.

Lövinsohn's cases<sup>2</sup> are collected from Czerny's Heidelberg clinic between the years of 1883 and 1886, and are sixteen in number; they were published in 1893. One patient died of collapse, the direct result of the operation, giving a percentage mortality of 6.2. Nine lived for two years and longer, the exact periods being

2 patients	lived	2	years
1 patient	"	2½	"
2 patients	"	4	"
1 patient	"	4¼	"
1	"	6¾	"
1	"	7	"
1	"	8¾	"

Of these nine cases, all died, with the exception of two, of a recurrence of the disease. The two exceptions are those of 6¾ years and 8¾ years, where it is noted that the patients were alive and free from any sign of return. In one of the cases

<sup>1</sup> *Beiträge zur klin. Chir.* 1892, Bd. ix. Heft ii. p. 409.

<sup>2</sup> *Ibid.* 1893, Bd. x. p. 223.

which lived for four years, the recurrence took place in the liver.

The inferences to be derived from these statistics are (1) that the operation itself is not a fatal one, the mean percentage of mortality of these two operators being 5·3: (2) that prolongation of life is possible in suitably selected cases: (3) that extirpation of the disease with permanent cure is comparatively rare.

*Prognosis in the sacral operation* is in many respects much more difficult and much graver than in the case of the perineal operation. In the first place the operation deals with disease in a part of the bowel where there is much difficulty in deciding the character and extent of the growth, and therefore the possibility of its complete removal; this feature is well illustrated in my own case, narrated in full below, where it was not until the performance of the operation, and the actual exposure of the seat of the disease, that the extent to which it had involved the sacral glands was discovered. In the second place the severity of the operation removes that assurance of immediate success which as a rule attends the perineal excision. Still further, it is impossible to foresee how far the result of the operation may correspond to what was aimed at; and how far the subsequent conditions may even be aggravated by the operation.

The question may be first asked, What are the results which may follow this method of excision apart from those connected directly with the operation and those concerning the possibility of effecting a cure?

The most favourable result, apart from the question of total removal of the disease, and that unfortunately least often obtained, is complete control of the bowel. How this may be effected independently of the retention of the normal sphincters will be described under the section of operations. Suffice it to say here, however, that in by far the large proportion of cases there is incontinence of fæces to a greater or less extent. In many instances, fæcal fistulæ form in some part of the posterior wound; in not a few, also, these fistulæ enlarge until they form the sole exit for the discharge. Again, it may be found, after the removal of the growth, that it is impossible to retain the anal section of the gut, or even

to bring down sufficiently the upper segment in order to attach it below. In such cases a sacral anus has to be established. As a last remote effect may be mentioned cicatricial contraction, and consequent obstruction.

Following more directly upon the operation are results dependent upon septic infection of the wound. These, fortunately, have not been of a very frequent character; and, although possible, they need not be introduced as arguments of much cogency against its performance.

Now, as regards the mortality of the operation and the possibility of obtaining a cure.

In Czerny's series of 36 cases operated upon by the sacral method there were 7 deaths due directly to the operation, giving a mortality of 19·4 per cent. There were living at the time the report was made, eighteen. Of these,

6	{	3 after $2\frac{3}{4}$ years
		1 " $2\frac{1}{3}$ "
		2 " 2 "
12 from $1\frac{3}{4}$ year to 5 months.		

Nine had died from recurrence, metastases, &c. within the period over which the series extends—that is, six years. Some of these cases are reported as being in good health and as having returned to their accustomed work.

From this series it will be seen that there is no record of any having passed the three-year limit, although it is quite possible that some may have done so by this time.

The question regarding this operation now comes to be one of determining whether the good that it can effect sufficiently outweighs the untoward results that frequently follow; in other words, does the prolongation of life and the relief of suffering more than compensate for the lives it shortens, and the often additional troubles it causes? It need hardly be said that the question is one of extreme difficulty; for even if it could be shown that Czerny's results gave a balance in favour of the operation in supposed suitable cases, it far from follows that less experienced operators, in such a grave and comparatively difficult operation, would obtain like good results. Indeed, if one may judge from isolated instances recorded—and it may reasonably be accepted that it is mostly the successful cases which are published—results argue rather

against than for the operation. And as regards opinions, surgeons, in this country at least, are not disposed to give it more than a very scanty recognition, and but a very limited application.

That, however, it is possible to remove the disease entirely and leave the patient in comparative enjoyment of health and with the ability to do his ordinary work in daily life, is a sufficient justification for the operation *per se*. It only remains for the surgeon to consider, in attempting to gain such a desirable end, whether the case, in the first place, appears to him a really suitable one; and whether, in the second, he is prepared to recommend it to his patient in the face of the various risks and the untoward results which are not only possible, but proportionately probable to the limited experience he may have had in performing the operation.

Before passing from the prognosis connected with these two operations, the perineal and the sacral, a few facts brought out in Lövinsohn's paper are worthy of note. The author deals with the results of these two operations combined, and treats collectively of the cases operated upon in Czerny's Heidelberg clinic between the years 1878 and 1891, thus including Heuck's published statistics between 1878 and 1882, and Schmidt's between 1886 and 1891, his own series filling up the gap of three years between 1882 and 1886.

There were 109 radical operations, with 10 deaths. Of the 99 surviving patients,

21	lived	for	2	years	or	longer
15	"	"	3	"	"	"
13	"	"	4	"	"	"
8	"	"	5	"	"	"

Four patients lived for  $13\frac{3}{4}$ ,  $11\frac{1}{2}$ ,  $8\frac{3}{4}$ , and  $6\frac{3}{4}$  years respectively after the operation.

It is interesting to note that while we in Britain fix three years as the period for considering a patient as cured if no return is observed, and that in Germany the period is fixed a year earlier, these statistics unmistakably show that the limit is far from being a reliable one. Thus a return of the disease was observed after periods of four, six and a half, and seven years. Volkmann also observed recurrences after periods of three, five, and six years, and in one case in the liver after

eight years. Hildebrand is also reported as having seen several recurrences in from three to four and a half years after operation.

Another interesting feature which these statistics bring out is the almost constant lack of any power of fæcal continence. In only two cases is it noted that there was complete continence, and in these the anus was not removed; in the remainder there was either no continence, or only slight power of retention when the motions were firm.

*Prognosis in regard to the formation of an artificial anus* is less difficult to give than in the preceding cases, for the operation no longer concerns the question of cure, but simply that of relief. Life may also be prolonged, in so far as it is affected by the relief to suffering, and the warding off of dangerous complications.

The operation, whether performed in the groin or in the lumbar region, is of such a simple and safe character, that of itself it need not be considered as affecting the prognosis. When it has proved fatal it has usually been in cases of extreme gravity, such as in operations upon patients far gone with symptoms of intestinal obstruction.

In forecasting the result of the operation, it may be said to give immediate relief in most instances, by lessening the pain and removing the obstruction; but it adds the inconvenience and discomfort necessarily connected with the involuntary exit of fæces in the groin or in the loin. As a rule patients are ready to face these inconveniences rather than endure the suffering which comes of inability to get a proper movement of the bowels.

As regards the effect an artificial anus has in prolonging life, much must depend upon the nature of the disease and the condition of the patient. By the performance of the operation upon a patient on the verge of death from obstruction, life is not only prolonged, but actually saved. On the other hand, to make an anus, merely because a patient has malignant disease, from which he neither suffers nor is inconvenienced, would be to add a discomfort, without probably in any way checking the onward progress of the tumour. If, however, the patient is slowly sinking from the pain and trouble associated with the passage of fæces

over the part, there is little doubt that life will be spared for a longer period than if the operation had not been performed. In a case recorded by Allingham,<sup>1</sup> where a mass filled the pelvis, the patient lived four and a half years after the operation.

---

## CHAPTER LXXVI

CARCINOMA (*continued*). TREATMENT. SARCOMA

**Treatment.**—Sufficient has been said regarding the pathology, symptoms, and prognosis of the disease to indicate how largely treatment must depend upon the circumstance of each individual case. It is possible, however, to simplify the discussion of the subject by making a primary division of the cases to be treated into those which are operable and those which are not, and then subdividing the former into cases suitable for extirpation and those best fitted for the formation of an artificial anus.

*Treatment of non-operable cases.*—In this class of cases are included all those which are considered too advanced for any purpose to be served by subjecting the patient to an operation, and those who refuse to have anything done.

The treatment necessary concerns the relief of the symptoms by palliative or conservative measures. Prominent among these must be the regulation of the bowel and the adoption of a suitable diet. Mild laxatives should be administered. A morning draught of one of the aperient waters is often of much service in this respect. In diet nothing should be taken which is liable to irritate the bowel or tend to produce constipation.

When there is much offensive and irritating discharge from the diseased part, cleanliness is of much importance, not only in lessening the deleterious effects such discharges have by absorption upon the general health of the patient, but in preventing the excessively painful fissures and excoriations which form in and around the anus. Injections of warm antiseptic solutions should be frequently used. Condy's fluid, largely diluted, acts as a powerful deodoriser; a solution of naphthol, about four grains to the quart, is recommended by Beaumetz.<sup>2</sup>

<sup>1</sup> P. 300.

<sup>2</sup> Mathews, *Diseases of the Rectum and Anus*, p. 389.

A sitz bath is also serviceable; and the occasional insertion of an iodoform suppository is sometimes useful.

The relief of pain is sometimes of paramount importance, and should be treated with some consideration. The administration of opium and its preparations, either hypodermically or as suppository, will in most instances give the required relief; but if its administration is commenced at an early period of the disease, the original dose soon begins to fail in producing its effect; so that while the pain increases, the influence of the drug diminishes. Hence, to give the necessary relief, the amount has to be increased. The gradual addition to the quantity administered is liable to produce a craving for the drug, and this becomes so intense in some cases that patients have been known to confess that the suffering connected with the insatiable desire for the drug was worse than that associated with the disease. To guard against such a result, opium should be kept as a last resource, and then when given, only the smallest dose capable of producing the desired effect. This rule also applies to every addition that is made to the strength of the dose. Among sedatives which may be locally applied for the relief of pain are cocaine, hyoscyamine, and belladonna. Treves<sup>1</sup> adopts the following formula: Begin with suppositories containing cocaine; when these cease to be effectual, replace them by suppositories containing hyoscyamine; and when these fail, others containing opium and belladonna are tried. Lastly, morphia suppositories are given.

Two other measures must be considered, which occupy a position, however, somewhat between the purely conservative and the purely operative; these are relief of the obstruction by division of the stricture either partially or completely, and curetting or scooping away the tumour when of a sufficiently soft character. Neither method is likely to appeal with much force to surgeons; nevertheless it is right to indicate that such a good authority as William Allingham advises both in certain cases, and has practised them with good effect. Cases suitable for 'scooping' are those which are clinically designated 'encephaloid;' to be effectual and avoid much bleeding, the tumour must be well 'scooped' away until more or less normal tissue is reached.

<sup>1</sup> *Clin. Journ.* 1893, vol. i. p. 222.



Partial division of the stricture, by incising it in one or two places, must be followed up by the use of bougies.

Complete division or the performance of linear or posterior proctotomy will give temporary relief, but inasmuch as the operation involves division of the sphincters, fæcal incontinence must follow.

*Treatment of operable cases.*—Which of the two operations should be performed in any case—that is to say, extirpation or the formation of an artificial anus—must be decided solely on grounds of whether or not it is considered possible to remove the whole primary seat of the disease.

When the question concerns the performance of the perineal operation, it is not usually very difficult to decide. In these cases the seat of the disease is open to careful investigation, and it is approximately possible to determine the extent of the bowel involved, both superficially and deeply. When the growth is localised or the stricture limited, removal may be considered the proper course to adopt if in neither case there is any indication of fixation of the part to the deeper structures. Thus if it is fixed to the sacrum, or to the bladder, prostate, or urethra in the male, and the vagina or uterus in the female, the case is not a suitable one for extirpation unless the surgeon is prepared to go to great lengths and freely remove all parts which appear involved, heedless of the consequences which may result, so long as the disease is removed. It may, however, well be doubted whether such mutilation is justified, considering the wretched state in which the patient must be left and the extreme improbability of eradicating the disease.

When the question is one concerning the performance of the sacral operation, much depends not only upon the more or less conjectural opinion regarding the nature and extent of the growth, but upon the general condition of the patient. The operation is a severe one, and the shock often considerable; hence, while the diseased part may seem suitable for removal, the patient's strength may not be deemed equal to the possible loss of blood and the shock which its performance will probably entail.

There are certain other conditions which may be considered as practically inhibitory to the performance of extirpa-

tion by either method. These are the existence of obviously enlarged glands, either in the sacrum or in the abdomen, along the lumbar spine: marked enlargement of the liver, with possibly ascites: advanced disease, as shown by a marked cachexia and general loss of flesh and strength: fistulous communication with bladder, urethra, vagina, or uterus; and in cases of acute intestinal obstruction when urgent relief is required.

If extirpation is not deemed advisable from any of the causes above given, the question then becomes one regarding the formation of an artificial anus. In cases of acute obstruction or recto-vesical fistulæ, an artificial anus should be made; but, short of such complication, the operation is one to be selected by the patient rather than urged by the surgeon. The possibility of relief and prolongation of life, as well as the converse possibilities; and the additional inconveniences of an incontrollable fæcal orifice must all be honestly placed before the patient, with such opinions as the surgeon may feel justified in expressing from his experience, and his knowledge of the nature and extent of the disease.

CASE CXI.—*Posterior proctectomy (Kraske). Recovery with sacral anus.*  
(Abstract from report taken by Dr. Symington.)

J. R., aged 35 years, has all his life suffered from constipation; five months before admission to the infirmary he first noticed blood in his motions. His difficulty in defecation has been gradually increasing, and recently he has been obliged to take aperients in order to get a movement of his bowels. Pain is usually felt above the umbilicus before defecation, but the act itself does not cause undue inconvenience, unless the motions are more than usually costive. He has lost strength and body weight, and his appetite has become much impaired. The man himself is well built and muscular, with ruddy complexion, and no marked evidence of being much affected by the disease. A digital examination of the rectum reveals a well-marked tight stricture, about two inches up from the anus. It is somewhat irregular, and its upper limit cannot be gauged. The patient was prepared for operation by the administration of an ounce of castor oil the day before.

*Operation.*—With the assistance of Drs. Grant Andrew, Paterson, and Symington posterior proctectomy was performed (Kraske). After exposing the rectum a transverse incision was made about an inch above the anus, and the upper portion stripped upwards until it could be severed above the stricture. Much adhesion existed between the bowel and the sacrum at the upper part, and this was found to be due to a mass of tumour growth (probably glandular), the removal of which constituted the most

difficult part of the operation. After removal of the bowel it was found that the peritoneal cavity had been opened; it was closed by suture. The upper portion of the bowel was now brought down, and its edges stitched to the edges of the anal part of the gut below. This was effected without any tension of the sutured edges. Fæces having escaped into the wound, it was freely irrigated and then stuffed with iodoform gauze. A large-sized rubber tube was introduced into the anus, and pushed well up above the sutured margin. The hæmorrhage was very free at every stage of the operation, the bleeding being mostly of a parenchymatous character, and stopped by pressure.

In the afternoon, about five hours after the operation, the patient was attacked with severe griping pain in the hypogastrium. The dressings were found soiled with fæces, which proved to be passing freely from the bowel between the sutured extremities and into the wound.

The patient made an uninterrupted recovery, gaining strength, and putting on flesh. The fistula finally assumed the condition of a sacral anus.

The tumour, when examined microscopically, was shown to be of the usual type of columnar-celled carcinoma. (A. Ernest Maylard, 'Trans. Path. and Clin. Soc., Glasgow, 1895, vol. v. p. 59.)

The case presents two features of special interest. One has already been referred to, that regarding the extent of the disease towards the sacrum, which was not discovered until the bowel was separated from its connection. The other has reference to the inefficient emptying of the bowel by an aperient before operating. This will be noticed again in describing the methods of operation. It teaches that when it is not possible from the tightness of the stricture to efficiently clear the bowel above, a preliminary sigmoidostomy should be performed.

CASE CXII.—*Carcinoma of rectum : sigmoid anus. Recovery.*

(Abstract of report taken by Dr. Alexander MacLennan.)

W. McC., aged 30, a ploughman, was admitted into the Victoria Infirmary, Glasgow, on July 3, 1895. About fourteen months previously he commenced to be troubled with constipation, and noticed that blood occasionally passed either before or during the motion. To obtain a movement of his bowels, he always found it necessary to take aperient medicine. No pain was noticed at the earlier period of his disease, and he attributed his condition to the presence of piles. About four months back, pain was first felt, and was then like a weight in his bowel. It has now come to be paroxysmal in character, and he has to do all he can to retain himself from crying out. It is worse at night and on going to stool. In addition he has a sensation of burning in the bowel. He also complains of shooting pains in his legs, especially in the left leg, and in the small of his back. The patient looks a strong healthy man, but states that since

April last he has been losing flesh. He does not care for his food, and feels very weak. There is no apparent enlargement of the liver. Examination of the rectum reveals a dilated cavity, and the finger impinges against an obstruction which proves to be an annular stricture; the gut also presents a 'bossy' sensation in the neighbourhood of the disease. The finger readily passes through the central opening, and the thickness of the growth as thus determined is probably about an inch. The tumour commences about two inches and a half from the anus. The bowel appears movable in front with no implication of the prostate or bladder. Behind, it is firmly fixed to the sacrum, no mobility of the parts being possible.

On July 24, after ten days' inability to get a proper movement of the bowels, the patient was advised to have an artificial anus made. The case at this time was not urgent, and there was no abdominal distension; but the prospect not being hopeful from the rate at which the growth was increasing, and the continuance of obstruction, it appeared wiser to open the bowel rather than to delay doing so until compelled. A left sigmoid anus was made, but the bowel not opened until the following day, when the onset of obstructive symptoms necessitated the giving of immediate relief.

The patient left the infirmary about two months after the operation, greatly improved in health, and in every respect satisfied with the relief he had experienced since the operation. (A. Ernest Maylard, Victoria Infirmary, Clinical Reports, 1895, No. 1113.)

**Sarcoma.**—Sarcoma is rarely met with as one of the forms of malignant disease attacking the rectum. Excluding such exceptional and possibly doubtful instances as that described as 'ossifying cancer,' already referred to, almost every recorded case illustrates the melanotic type of the growth. Heaton showed at the London Pathological Society<sup>1</sup> a specimen of a tumour removed from the right side of the rectum. It consisted of a dark-coloured bleeding mass about the size of a small orange. After its removal another mass was felt behind the rectum, higher up, between the bowel and the sacrum and beyond reach of removal. Examined microscopically, the growth was found to consist of round cells containing melanotic pigment in variable quantities. Bowlby, at the same meeting of the Society, referred to a similar case which had come under his observation; and Pitt pointed out that the late Hilton Fagge had described the rectum as being one of the primary seats of melanotic growth. Lange<sup>2</sup> exhibited a specimen of the disease at the New York Surgical Association.

<sup>1</sup> *Trans.* 1894, vol. xlv. p. 85.

<sup>2</sup> *New York Med. Journ.* 1887, vol. xlv. p. 274

Cooper and Edwards<sup>1</sup> refer to ten cases collected by Nepveu, and to one published by Ball.

A case of spindle-celled sarcoma is recorded by Lewis.<sup>2</sup> A man aged 43 years had for three years suffered from increasing difficulty in defecation. When first seen, a tumour about the size of a foetal head was felt in the rectum. By an effort on the part of the patient it could be made to appear outside the sphincter. The tumour arose from submucous tissue and was covered by mucous membrane. It was easily enucleated.

---

## CHAPTER LXXVII

### PROLAPSE

THE protrusion beyond the anus of any portion of the bowel constitutes a prolapse; and inasmuch as this protrusion may vary between a slight eversion of the mucous membrane and a complete turning out of the whole rectum, two terms have been introduced to signify the more or less opposite extremes. Thus, when only the mucous membrane is everted for a short distance, the condition is termed *prolapsus ani*; and when the whole bowel is everted it is called *prociencia recti*. Between these two extremes, however, there is every gradation; and in order to include those forms which do not come strictly under either of the two already given, a division is sometimes made into *partial prolapse* and *complete prolapse* of the rectum.

The condition may be met with at any period of life, but is more frequent at the two extremes. In the young the varicous degrees of partial prolapse are mostly seen; while in the old the prolapse tends towards the complete form.

The smaller the length of the prolapse the more likely is it to consist simply of mucous membrane, while the greater its length the greater the probability that all the coats of the bowel will be everted; and if the protrusion be of sufficient length, a pouch of the peritoneal cavity will exist between the outer and inner tube in front, or, in extreme cases, the whole way round.

<sup>1</sup> P. 210.

<sup>2</sup> *Boston Med. and Surg. Journ.* 1883, vol. cix. p. 620.

As indicating the comparative frequency with which the affection is met with in children, Logan<sup>1</sup> reports that at the Liverpool Infirmary for Children about thirty-two cases are seen per annum.

**Causes of prolapse.**—In the majority of instances the protrusion is indirectly due to causes which induce an exaggeration of the normal ejaculatory functions of the rectum. In addition there are certain predisposing influences, both normal and pathological, which materially aid in allowing these unnatural exciting causes to produce their effect. Thus in young children the rectum has less support than in the adult, due in part to the absence of any well-marked curve in the sacrum and to the natural elasticity of the tissues. Among pathological influences are such as produce a want of tone in the parts, as for instance debility from any cause. The effect of these constitutional conditions is (1) to produce a weakening of the muscular coat of the bowel, the sphincters, and the slinglike and supporting action of the levator ani, partly as the result of lack of nerve power and partly from wasting of the muscle tissue: (2) to remove the padlike support of the fat in the ischio-rectal fossæ; and to weaken the connective tissues which unite the mucous membrane to the muscular coat.

The causes which bring about undue action of the rectum in children are whooping cough, diarrhœa, intestinal worms, the presence of a rectal polypus, phimosis, stone in the bladder, and the prejudicial habit of allowing a child to sit for too long a time upon the stool after the required movement of the bowels has taken place. As regards diarrhœa, Logan remarks that prolapse is most frequent at the ages and at the times of the year when this condition is most prevalent.

In the case of adults similar causes may be present, such as rectal polypus and vesical calculus; in addition, however, there are causes peculiar to adult life and advancing age, such as chronic constipation, hæmorrhoids, urethral stricture, and enlarged prostate.

The formation of a prolapse is sometimes sudden, but more frequently it is gradual. When arising suddenly, it is generally traceable to some excessive straining effort. When gradual,

<sup>1</sup> *Liverpool Med. Chir. Journ.* 1891, p. 380.

the mucous membrane prolapses in the first place, and then, by its constant and increasing dragging effect, it causes the muscular tunic to follow, and a complete eversion is produced.

**Symptoms.**—It is somewhat difficult, if not strange, to speak of the symptoms of what is in itself practically only a symptom; for, as above shown, the condition is almost invariably the result of some definite cause, which must be successfully dealt with in the first place if the prolapse is to be prevented. However, if the prolapse is secondary to some other trouble, it nevertheless creates obvious troubles and inconveniences directly traceable to its own existence.

The appearance of a prolapse is not likely to be mistaken after careful examination of the part. When the protrusion is only slight, it may resemble the projection of internal hæmorrhoids, or a polypus; but neither of them need mislead if, as stated, the part be carefully examined by the eye and the finger.

A typical protrusion of the gut presents either the appearance of a cylinder or of an inverted cone, with the mucous membrane either smooth or more or less transversely or obliquely plicated. At the apex and in the centre of the cone or cylinder is the orifice of the bowel. When small intestine bulges into the peritoneal pouch on the anterior aspect of the prolapse, it is apt to cause the orifice at the apex of the protrusion to be directed somewhat backwards. The sides of the prolapse slope upwards and become continuous with the skin surrounding the dilated and stretched anal orifice. The appearances of the mucous membrane vary according to the acuteness or chronicity of the case. When only recently protruded, it may be florid in colour, covered with mucus, and prone to bleed; but when the case is of old standing, and especially if the prolapse remains down, the membrane becomes pale in colour and more or less indurated, resembling skin, or, if very tough, not unlike leather. Patches of ulceration are sometimes present.

Most of the symptoms strictly attributable to prolapse of the rectum arise when for some reason the bowel cannot be immediately and easily returned after its descent. The constant dragging effect of the prolapse, and the constriction

at the anus, tend each to produce its own train of symptoms. Thus the anatomical relation of the urethra and the bladder in the male causes this part to be pulled upon by the prolapse, so that pain and difficulty in micturition may result; and in some cases retention of urine is caused. The dragging upon the rectal nerves may also induce distressing pain in the loins and down the thighs. When constriction takes place at the anal orifice, the prolapse becomes strangulated and acute pain immediately follows, with congestion, inflammation, and possibly sloughing of the part. In exceptional instances the prolapse completely sloughs off, and a natural cure results.

In chronic conditions of prolapse there are apt to be frequent attacks of bleeding, while constipation alternates with diarrhoea. In some cases there is faecal incontinence. The straining also, which is sometimes a constant and aggravating symptom, has in rare instances resulted in rupture of the bowel. Such an exceptional complication is recorded by Masimoff.<sup>1</sup> A woman aged 75 had suffered for nine years from habitual prolapse of the rectum. While straining during defecation she suddenly felt acute pain, followed by protrusion of bowel from the anus. Quénu<sup>2</sup> also records a case occurring in a feeble old woman and under similar circumstances. When first seen, three feet of intestine, black and shrivelled, protruded from the anus. Laparotomy was performed, the bowel reduced, and an attempt made to suture the rent in the rectum, but without success. The patient succumbed.

**Treatment.**—It need hardly be pointed out that, inasmuch as prolapse of the bowel is in the majority of instances a symptom, the cause which has given rise to it needs to be rectified in the first place. Assuming therefore that the local or constitutional exciting or predisposing cause has been attended to, the treatment of the prolapse may next be considered.

In *children* the simplest method of treatment for slight cases consists in first placing the child on its abdomen across the mother's knees, the buttocks raised, and the thighs flexed. The prolapse is cleansed, and then besmeared with some vaseline; gentle pressure is applied to the apex of the cone

<sup>1</sup> *Annals of Surgery*, 1890, vol. xii. p. 281.

<sup>2</sup> *Medical Press and Circular*, 1888, N.S. vol. xlv. p. 141.



or cylinder with the fingers until it slips up within the anus. The child should afterwards be kept in the recumbent position ; a pad and T-bandage applied, or the buttocks held close together by strips of adhesive plaster. All motions should be passed while the child lies on its side ; and in order to exercise some restraining effect against the return of the prolapse, one buttock may be drawn aside, so as to put tension on the anal orifice while defecation takes place.

When the prolapse shows a tendency to recur, the patient may be treated with some form of astringent. Bryant<sup>1</sup> advocates the free application of nitrate of silver as stick to the whole mucous surface, previously wiped with lint and subsequently mopped. Or, as recommended by Henry Smith,<sup>2</sup> the part may be bathed with a solution of sulphate of iron, one grain to the ounce of water. Another method is to use astringent injections after a motion and after the bowel has been returned. For this purpose three or four ounces of water containing three grains of tannic acid to the ounce may be used, or a decoction of oak bark with or without alum.

As further adjuncts towards maintaining the bowel in position, some form of rectal pessary may be used. Logan employs a perforated celluloid tube, three-eighths of an inch in external diameter and four inches long. Ball advises an oval knob of vulcanite with a very slender curved shank, to which a piece of twine is attached.

Should the case still resist such simple measures, the mucous membrane of the prolapse must be painted over with strong nitric acid, a camel's-hair brush being used for the purpose. Chloroform must be administered, the mucous membrane dried, and care taken not to touch the skin around the anus with the acid. After the application the part is oiled and returned, and the rectum stuffed with some cotton wool. The straining which is liable to follow upon the child's recovering consciousness necessitates the application of a pad and bandage, and the strapping of the buttocks together. Allingham<sup>3</sup> orders a mixture of aromatic confection with a drop or two of tincture of opium, in order to confine the

<sup>1</sup> *Practice of Surgery*, 3rd edit. vol. i. p. 715.

<sup>2</sup> *Holmes's System of Surgery*, 3rd edit. vol. ii. p. 845.

<sup>3</sup> *Diseases of the Rectum*, 4th edit. p. 165.

bowels for four days. A teaspoonful of castor oil is then given, the strapping pad and bandage removed, and the first motion brings away the woollen stuffing. A single application of the acid is usually sufficient, but occasionally a second and even a third may be required.

In any case where there is difficulty in reducing the prolapse in children, the result of crying and straining on the part of the patient, chloroform should be administered, so as to avoid injuring the bowel by any undue force.

---

## CHAPTER LXXVIII

PROLAPSE (*continued*). TREATMENT IN ADULTS. INTUSSUS-  
CEPTION. RECTAL HERNIA. RECTOCELE

IN *adults* the prolapse, if of any magnitude or chronicity, is seldom amenable to such simple measures as in the case of children. In recent cases, however, and in such as consist of the prolapse of mucous membrane only, astringent injections should be tried, or the systematic employment of cold-water enemata, before attempting any more radical means.

When operation becomes necessary, several methods are at present in vogue, all of which have been practised with success; and although their respective merits are regarded with very variable degrees of approval among surgeons, they at least deserve recognition both for the ingenuity which characterises some and the good results that have followed in all.

Among the more conservative measures are the use of the clamp and the cautery: the application of the cautery alone; the excision of an elliptical portion of the mucous membrane; or this in conjunction with the skin, as practised by Roberts.

Severer operations consist in amputation of the part by methods proposed respectively by (A) Mikulicz, by (B) Treves, and by (C) Kleberg: in elevation and fixation of the prolapse, either (A) by way of the sacrum, as proposed by Verneuil, or (B) by transfixion above Poupart's ligament, as carried out by McLeod, or (C) by preliminary laparotomy, as practised by

Berg. Lastly, a method for narrowing the canal has been proposed by Lange, which, following the nomenclature used in other parts of the intestine, might be called 'proctorrhaphy.'

**By clamp and cautery.**—By this method folds of mucous membrane are clamped in a similar way to that in which hæmorrhoids are secured. The clamped portion is removed either by the thermo-cautère or heated irons; in each case the heat should not be beyond that which produces a dull red colour. The amount to be removed depends upon the nature and extent of the prolapse. Several portions may need to be clamped, and where the anal orifice is very patulous a piece of skin may also be included. Henry Smith<sup>1</sup> advocates and practises this method in preference to others.

**By cautery.**—This method of treatment was suggested by van Buren of New York, and was advocated and practised by the late William Allingham,<sup>2</sup> who thus describes the operation:

'The patient is put under the influence of ether, and if the part be not down it can be readily drawn fully out of the anus by the vulsellum. I then, having the intestine held firmly out, with the iron cautery at a dull red heat, make four or more longitudinal stripes from the base to the apex of the protruded intestine. I take care not to make cauterisation so deep towards the apex as at the base, because near the apex the peritoneum may be close beneath the intestine, while a deep burn near the base is not so dangerous. I take care to avoid the large veins which can be seen on the surface of the bowel. If the procidentia be very large I make even six stripes. I then oil and return the intestine within the anus; having done this I partially divide the sphincters on both sides of the anus with a sawing motion of the hot iron, and then insert a small portion of oiled wool.'

The patient is kept in the recumbent position for a month or six weeks, and the motions are passed while the patient is lying down.

The principle of the treatment is to lessen the calibre of the canal by the cicatricial contraction which follows upon the healing of the ulcers after the separation of the sloughs;

<sup>1</sup> *Lancet*, 1893, vol. i. p. 459.

<sup>2</sup> *Discuses of the Rectum*, 4th edit p. 169.

and the formation of inflammatory adhesions between the mucous and the muscular tunics of the rectum.

This operation can also be performed after the prolapse is reduced. In such cases a wire or other suitable speculum is used, which will admit of the iron or cautery being introduced and the mucous membrane seared as above.

**By elliptical excisions.**—This method has for its object a similar result to that attained by the use of the cautery. Elliptical portions of the mucous membrane are excised in the longitudinal axis of the bowel. Their removal necessitates the healing of the raw gaps by cicatricial tissue which results in a narrowing of the canal. When, however, there is much dilatation of the anus, something further is needed in the way of narrowing this orifice. The operation devised by Roberts appears best suited for the purpose.

*Roberts's operation.*<sup>1</sup>—The operation is thus described by its author in narrating a case successfully treated by it.

‘The patient was put in the lithotomy position and the protruded rectum fully reduced. I then made a small incision in the median line of the perineum, near the point of the coccyx; into this I inserted my finger and broke up the cellular connections posterior to the rectum, in a manner similar to that adopted in excision of the lower end of the rectum for carcinoma. A knife was then introduced into the dilated anus at a point half an inch to the right of the median line, and a deep incision carried obliquely backward so that it divided the anal sphincter and skin from the aperture of the bowel to the original incision made at the end of the coccyx. The knife was then introduced into the anus upon the left side of the median line, and a similar incision carried back to the original wound in the perineum. These oblique incisions included between them a triangular portion of tissue consisting of skin, subcutaneous cellular tissue, and an inch of the sphincter muscle. The base of the triangle was at the margin of the anus; its apex was at the extremity of the coccyx. About one inch of the sphincter muscle was thus excised by the two incisions. With scissors I then cut out of the posterior wall of the rectum a long triangular piece

<sup>1</sup> *American Journal of the Medical Sciences*, 1893, N.S. vol. cv. p. 541.

embracing the entire thickness of the wall, which, in the first step of the operation, had been separated from its pelvic connections. The apex of this V-shaped section of the wall of the rectum was situated about three inches up the gut, while its base corresponded with the inch of the sphincter muscle of the anus, which had been included between the incisions previously described.' (See fig. 105.) 'After hæmorrhage had been controlled by catgut ligatures, chromicised catgut sutures

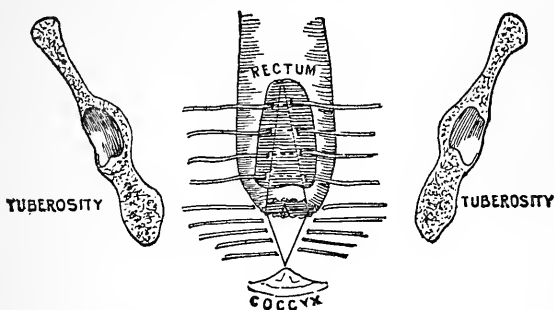

FIG. 105.—ROBERTS'S OPERATION FOR PROLAPSE OF THE RECTUM

were used to bring the divided wall of the rectum together. The first suture was introduced at the apex of the rectal wound; that is, three inches above the anus, and was tied with the knot within the bowel. Successive sutures were similarly inserted and tied at intervals of about one-third of an inch. The last intrarectal suture was placed just inside the margin of the anus. The sutures were all tied with the knots upon the mucous surface of the bowel. . . . The ends of the divided anal sphincter, which were left by the excision of one inch of that muscle, were then brought together by two catgut sutures, and one wire suture, which was shotted. . . . A rubber drainage tube was then introduced into the space between the rectum and the sacrum, and the wound leading backward from the anus to the coccyx was closed by numerous shotted wire sutures carried deeply through the structures by means of a strong curved perineum needle.'

In place of using gut for sutures, Roberts now advocates sterilised silk; and also advises that the bowels be kept well confined for a few days by opium.

Two cases successfully treated by this method are reported by Kammerer,<sup>1</sup> and one by Bell.<sup>2</sup>

**By amputation.**—(A) *Method of Mikulicz.*<sup>3</sup>—The patient is placed in the lithotomy position, and the prolapsed bowel properly cleansed and disinfected. The operator then inserts the index finger of the left hand into the prolapse, and cuts through

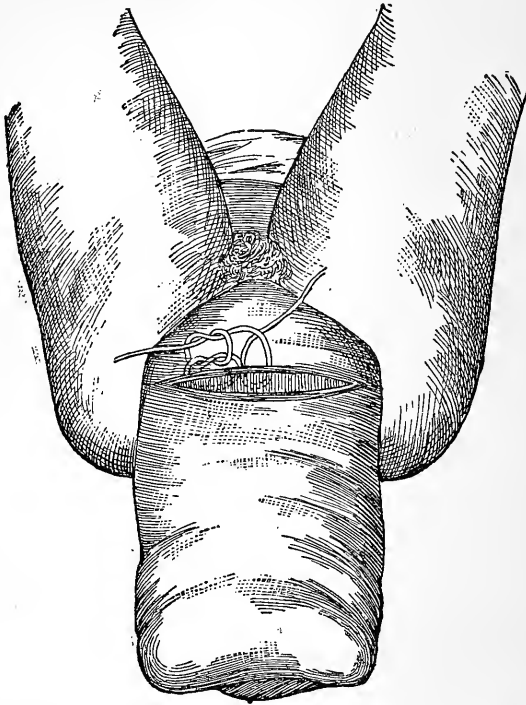

FIG. 106.—MIKULICZ'S OPERATION FOR PROLAPSE OF THE RECTUM. (Bogdanik)

with a knife the external intestinal tube for about two centimetres parallel to the anal margin, and one to two centimetres distant from it. Care is then taken to note that nothing exists between the inner and outer tube. This being observed to be empty, a stitch is then passed so as to unite both tubes; a reef-knot is tied, one end left short and free, while the other

<sup>1</sup> *Annals of Surgery*, 1894, vol. xix. p. 240.

<sup>2</sup> *Ibid.* 1891, vol. xiii. p. 333.

<sup>3</sup> Bogdanik, *Archiv für klin. Chir.* 1894, vol. xlvi. p. 847; also Volkmann *Berliner klin. Wochenschrift*, 1889, No. 46, p. 994.

is used as a continuous quilted suture through the rest of the circumference of the bowel. As the stitching proceeds and the needle is passed through the two tubes, the external tube is cut, so that by the time the prolapse has been stitched completely round, the external tube has been entirely severed. The internal tube is now cut through, and the cut edges of the mucous membrane united by a continuous suture all round. The stump is prevented from slipping within the anus by being held with forceps. There are no vessels to tie, because the process of stitching has effectually secured them before the two tubes are severed. The stump is finally cleaned and allowed to slip back within the anus.

(B) *Method of Treves*.<sup>1</sup>—The following is an abstract of the method as practised by its author in a severe case of prolapse, the protrusion measuring five inches in length, and ten and a half inches in circumference at its base.

The patient was placed in the lithotomy position, and the prolapse drawn down to its full extent. The mucous membrane forming the outer wall of the prolapse was now prepared for separation around the entire base of the cone, the knife traversing the skin close to its line of junction with the membrane. The tunic was then separated from the prolapse by means of scissors aided by traction, and was everted down to the apex of the cone, exposing the protrusion, now quite bared of mucous membrane. It was noted that there was a laxity of the wall at the base of the cone in front, but no small intestine appeared to be present, the raised position of the pelvis apparently effected gravitation of the bowel towards the abdominal cavity. The prolapse was then cut across at the level of the anus; that is, at the base of the cone. The anterior wall was first divided and the peritoneum opened, the opening being plugged with a sponge. The rest of the prolapse was then rapidly severed with scissors, the cut end of the bowel, muscular and mucous coats together, being seized with pressure forceps as each inch or so was severed; this allowed of the immediate arrest of all bleeding, and also prevented the mucous membrane from being withdrawn into the rectum, and held the cut end of the bowel in position. The small plug of sponge having been removed, the peritoneal

<sup>1</sup> *Lancet* 1890 vol. i. p. 397.

wound was closed by means of some six or seven points of the finest chromicised catgut. The divided ends of the bowel were next attached to the margin of the anus by sutures of silkworm gut involving the whole thickness of the rectal wall. As the pressure forceps were removed to prepare each segment of the divided rectum for fixing in place, any bleeding point was ligatured.

(C) *Method of Kleberg*.—The essential feature of this method of amputating is the use of an elastic ligature, by which means no hæmorrhage occurs and no prolapse of small intestine is possible. The mode of operating is thus translated from the original<sup>1</sup> by Kelsey,<sup>2</sup> from a case in which it was performed. ‘After the patient had pressed down the gut as far as he could, he was placed in the lateral position, on the operating table, with the pelvis raised and the shoulders turned downwards. After the administration of the anæsthetic, an assistant, surrounded with all the fingers the prolapsus from above, the points of the fingers being directed towards the free end of the prolapsus, and pressed as hard as possible into the gut at a point perhaps half an inch below the supposed sphincter. Immediately in front of the ends of the assistant’s fingers I then placed a good, fresh, unfenestrated drainage tube of rubber, a line and a half in diameter, around the prolapsus, and drew it only as tight as seemed necessary to stop the circulation. The elastic ligature was brought to the necessary tension by means of an easily untied slip-knot of silk thrown under it.

‘The assistant now had both hands free. . . . A few lines beneath the ligature I now made a longitudinal incision two inches long through the prolapsed gut, and in this way opened the sac formed by the drawing down of the peritoneum. Then I seized the elastic ligature with the forceps and fixed it firmly. It was thus an easy matter to push back into the peritoneal cavity a protruding loop of intestine without the slightest bleeding taking place into the wound or any air entering the peritoneal cavity, because the elastic pressure follows so rapidly all the movements, that no opening can exist anywhere.

<sup>1</sup> *Archiv für klin. Chir.* 1879, Bd. xxiv. p. 841.

<sup>2</sup> *Diseases of the Rectum*, 1883, p. 123.



‘ After I had convinced myself that the peritoneal sac was empty, and that no invagination of the intestine was present, but, on the other hand, only that part of the gut which was to be removed lay in front of the ligature, I thrust the largest size Luer’s pocket trocar through the prolapsus, immediately below the elastic ligature, from before backwards, and passed through the canula two elastic drainage tubes of a line and a half in diameter, and, after removing the canula, tied them as tightly as possible, one on the right side, the other on the left. These knots were secured against slipping by means of the knot of silk. The first provision against hæmorrhage—the elastic ligature applied after Esmarck’s plan—was then removed, and the prolapsus cut off with the scissors one inch in front of the permanent ligatures. After a few minutes’ time, during which I kneaded the parts, which still remained and lay above the ligatures, thoroughly, and as far as possible removed the fluids from them; I covered the parts around the stump with cotton, and soaked that part of the prolapse which still remained above the ligature with a solution of chloride of zinc, dried it, squeezed the soft parts once more, thoroughly applied the chloride of zinc again, and then covered the whole with dry cotton-batting, giving the patient instructions to remove this as soon as it became moist, and to replace it with dry, and to give the air all possible access to the parts.’

At the end of two months the patient is reported as being perfectly well. The prolapse was a severe one. It was a foot in length and six inches in diameter. In another case operated upon the result was fatal, but it is noted that the patient was in a very bad state of health.

**By elevation and fixation.** (A) *Verneuil’s method by way of the sacrum.*—The object of this operation is to fix the prolapse through an opening made in the coccygeal region, so that the bowel thus secured cannot descend.

The operation as translated by Fowler<sup>1</sup> is thus performed. ‘ After reposition of the prolapsed portion, with the patient in the lithotomy position, two incisions from four to five centimetres in length are made at right angles to the long axis of the anus, from the opening of the latter in an outward

<sup>1</sup> *Annals of Surgery*, 1891, vol. xiii, p. 218.

direction. From the points where these incisions terminate, two other incisions pass to meet each other at the point of the coccyx, thus including an equilateral triangle with its base placed anteriorly. This triangular flap is loosened from behind forward, and left temporarily attached to the tissues surrounding the anus, comprehending in its thickness the skin, the subcutaneous cellular tissue, together with the fibres of the external sphincter. With this flap strongly retracted by means of blunt retractors, the posterior wall of the rectum is loosened for a breadth of from five to six centimetres and to a height corresponding to the distance from the anus to the tip of the coccyx. Four threads are now passed transversely through the posterior rectal wall, parallel with each other, and not including the rectal mucous membrane. The upper one of these sutures is placed at a point in close relation to the point of the coccyx, while the lower one is removed about fifteen millimetres from the anus. By means of a needle with an eye at the point, which is passed through the skin from without, the threads are drawn through the points of emergence of their respective ends, being situated at about four centimetres from the median lines at either side. The upper suture should be on a level with the articulation between the first bone of the coccyx and the sacrum, and the lower at the point of the coccyx; the intervening sutures are placed about equidistant between. These are now secured upon one side in such a manner that the first and second, and the third and fourth, are tied together; rolls of iodoform gauze being placed beneath the loops to prevent the latter from being buried with the skin, strong traction upon these secures the rectum in its new position, and the other ends of the thread are similarly secured. The triangular-shaped flap is now removed, the muco-cutaneous anal margin being preserved, and after inserting a drainage tube, the wound is closed by sutures.'

This description of the operation differs essentially in one particular from the account I found of it.<sup>1</sup> It was there stated that the triangular flap is not removed, but replaced and sutured. Further, I translate the initial steps of the operation thus: A calculation is first made regarding the dilated

<sup>1</sup> *Gazette Hebdom. de Méd. et de Chir* 1889, vol. xxvi. p. 812.

anus, as to the extent of the boundary necessary to produce a normal-sized aperture. From points equidistant from the median line in front, and where it is believed the remaining anterior part of the anal circumference contains a sufficient margin when united to form a normal orifice, incisions are carried horizontally outwards for three centimetres. This appears to me more comprehensible than making 'two incisions at right angles to the anus.'

The narrowing of the anus is effected by uniting the margins at the two points at which the lateral incisions were carried out.

(B) *K. McLeod's method*<sup>1</sup> *by transfixion above Poupart's ligament.*—The essential feature of this operation is that the prolapse is dealt with from the abdomen. It was successfully practised by McLeod in a case thus :

'The left hand is passed into the bowel and the fingers are made prominent above Poupart's ligament. A long steel acupuncture needle is passed through the abdominal parietes into the cavity of the gut, guided across its interior by the fingers, and passed outwards until it emerges about three inches from the point of entrance. The needle should be parallel to and one inch above Poupart's ligament. Another needle is passed in the same way three inches above the first, and external to it so as to secure the intestine in an oblique position from below upwards. The upper end of the rectum (or it may be the lower end of the sigmoid flexure) is thus temporarily fixed in the desired position; the hand is then withdrawn. The next step is to make an incision, three inches long between the needles and at right angles to them, in the longitudinal axis of the intestine, as near as possible to the middle line of the attached portion. The layers are to be divided separately until the peritoneum is reached; the membrane will usually bulge out. The left hand is now reintroduced into the bowel, and, guided by the fingers, two series of loops of silk thread are inserted, four on each side, at a distance of about an inch apart, so as to attach the serous and muscular coats of the intestine to the abdominal wall. A series of these loops, also penetrating the two outer walls of the intestine, are placed between successive pairs of

<sup>1</sup> *Lancet*, 1890, vol. ii. p. 205.

these rows, in order to bring the lips of the wound together, and between them smaller horsehair stitches of adaptation are inserted.'

The patient upon whom the operation was performed made a good recovery. The steel pins were removed in twenty-four hours, and the horsehair stitches taken out on the tenth day.

(C) *By preliminary laparotomy.*—As distinguished from McLeod's operation, this method consists in first opening the abdomen and then *drawing* up the prolapsed bowel, and not *pushing* it up as just described.

Berg<sup>1</sup> mentions three severe cases where he operated by an abdominal incision. The abdomen was opened in the inguinal region, as for making a sigmoid anus. The prolapse was reduced, and the sigmoid flexure and upper part of the rectum drawn up and secured in this position by passing silk sutures through the whole thickness of the meso-rectum and the parietal peritoneum.

The three operations just described, consisting in each case of the reduction of the prolapse and fixation of the bowel above by suturing, constitute the operations known as *recto-pexy* or *proctopexy* when the rectum is secured, and *colopexy* when the colon is stitched to the parietes.

*Lange's method.*<sup>2</sup>—This mode of operating differs from those previously described in that it seeks to cure the prolapse by narrowing longitudinally the calibre of the canal. The operation is thus performed. The patient is placed in the knee-chest position, and an incision made from the lower part of the sacrum down to the anus until the posterior part of the rectum is reached; the coccyx is then removed. The rectal canal is narrowed by the introduction of 'buried étage sutures of iodoform catgut,' which do not perforate the entire thickness of the bowel. The first row are inserted near the middle line, and form a fold in the posterior wall, which protrudes into the bowel. The more lateral portions of the gut are then brought into apposition by a second row of sutures. Lastly, the cut edges of the levator ani and external sphincter are

<sup>1</sup> *Annals of Surgery*, 1893, vol. xvii. p. 373.

<sup>2</sup> *Ibid.* 1887, vol. v. p. 497.

united. The cavity is filled with iodoform gauze, and the flaps of integument united with sutures.

The case successfully treated by the author was a severe one. The prolapse was six inches in length : had existed for twenty years : and had resisted repeated treatment by cauterization and by excision of mucous membrane.

**Intussusception.**—Many cases of prolapse are preceded by intussusception ; that is to say, the upper part of the rectum becomes invaginated into the lower, and the intussusceptum continuing to descend, eventually presents at and projects from the anus, producing in the most extreme cases a typical example of prociencia recti. The most distinguishing feature of an intussusception is the sulcus which exists at the base of the prolapse. When the finger examines or traces upwards the mucous surface of the outer tube, it is felt to pass between two layers of mucous lining until it is checked by the reflection of the mucous membrane at the neck of the intussusception.

The symptoms of an intussusception which has descended sufficiently low to project from the anus are practically those of prolapse just described. But when an intussusception exists purely within the rectum, it is liable to be overlooked or mistaken for some other condition. The following case, reported by Cripps, illustrates the symptoms which may be present.

CASE CXIII.—*Intussusception of the rectum.*

The patient, a girl, was admitted into St. Bartholomew's Hospital with the complaint that for more than two years she had passed blood and a certain amount of slime daily. Whilst in the hospital the bowels acted several times a day, about a teaspoonful of blood passing with each motion. She generally strained a good deal, but had never noticed any protrusion. She had but little pain in the bowels or about the anus. She was very weak and anæmic from continual loss of blood. After a purge and a soap-and-water injection, the parts were examined, and appeared normal with the exception of a weak sphincter. There was no sign of piles. By gently drawing on the parts and telling the girl to strain, a small quantity of mucous membrane was everted, when by a sudden effort about three inches of the bowel shot out. At the top of some of the protruded rugæ could be seen several shallow ulcers about an eighth of an inch in diameter. As the prolapsed part became congested, blood at once commenced to ooze from the margin of two or three of the ulcers, and in a few seconds accumulated in sufficient quantity to drip.

The case was eventually cured by the use of the linear cautery. (Harrison Cripps, 'Brit. Med. Journ.' 1887, vol. i. p. 448.)

**Rectal hernia.**—In this rare form of hernia the small intestine projects through the anterior wall of the rectum, forming for itself a sac out of the recto-vesical or recto-vaginal pouch of the peritoneum and the expanded tunics of the rectal wall. The following example of this rare disease is reported by Lowe.

CASE CXIV.—*Rectal hernia.*

A woman aged 45 years developed a hernia of the small intestine through the wall of the rectum, as the result of constant violent straining efforts in lifting her invalid mother. The sphincter ani was dilated to an extreme degree, and there appeared to be an aggravated form of proidentia recti. Any straining effort caused the swelling to become tense and smooth, but relaxation of the effort caused the protrusion to partly recede, and the surface of the mucous membrane to become flaccid and covered with rugæ. In operating with the object of removing some folds of mucous membrane, a hernial sac was opened, and several coils of small intestine were forced out. These were reduced and the opening closed. The patient recovered, and became practically cured. (Lowe, 'St. Bartholomew's Hospital Reports,' 1891, vol. xxvii. p. 59.)

**Rectocele.**—'The condition is one due to an injury sustained in childbirth which becomes exaggerated as a woman passes the menopause, and as the vagina is shortened in after life.' This condition, which consists of an undue bulging of the anterior wall of the rectum through the posterior wall of the vagina, is usually discussed more fully in works upon gynecology than in those upon general surgery. Its treatment consists in narrowing the posterior vaginal wall, and so lessening the flaccid condition which has most to do with determining the rectal protrusion. For a full discussion of the causes and treatment of this condition the reader may be referred to a paper by Emmet,<sup>1</sup> from which the above quotation is taken.

---

## CHAPTER LXXIX

### MALFORMATIONS

IN 1860 were published two contributions upon the subject of rectal abnormalities, both of which have received world-wide

<sup>1</sup> *American Journal of Obstetrics*, 1890, vol. xxiii. p. 673.

recognition. The one was by Bodenhamer<sup>1</sup> of New York, and the other by Curling<sup>2</sup> of London. The latter discussed the subject from the basis of 100 cases collected from all sources, both home and foreign. In 1882 Cripps<sup>3</sup> followed with another series of 100 cases, collected also from all sources, and forming a continuation of those collected by Curling. In 1887 Jeannel<sup>4</sup> published an essay dealing exhaustively with the etiology and pathology of the subject; and in 1893 Ernst Anders<sup>5</sup> contributed what may be considered a résumé of all past work, including references to Bodenhamer, Curling, and Cripps up to the date of publication. Not the least instructive feature of this excellent paper is the tabulated account of 100 cases, showing the nature of the malformation, the operation performed, and the result.

Facts abstracted from these various contributions will be further referred to.

**Pathology.**—The various congenital malformations met with are the result of some defect in the normal process of development, which shows itself almost exclusively on the side of deficiency. For a proper comprehension therefore of these aberrations, a knowledge is required of the stages in the development not only of the rectum and anus, but also of the bladder, urethra, vagina, and uterus. It would, however, involve too lengthy a discussion of the subject to introduce this embryological aspect of it; but it may be briefly indicated that the rectum and anal portions of the bowel develop separately, and only become continuous by the later disappearance of the septum which interposes between the two cul-de-sacs; and that at an early period of fetal life, the lower end of the rectum and the genito-urinary tract constitute a common cavity, which later becomes divided into its normal channels by the growth of septa.

Thus it is easily seen how numerous must be the cases of malformation of the part, dependent upon more or less deficiency in the development of the various constituents which

<sup>1</sup> *Treatise on Rectal Malformations.*

<sup>2</sup> *Trans. Med.-Chir. Soc. Lond.* 1860, vol. xliii. p. 1871.

<sup>3</sup> *St. Bartholomew's Hospital Reports*, 1882, vol. xviii. p. 65.

<sup>4</sup> *Revue de Chirurgie*, 1887, vol. vii. p. 190.

<sup>5</sup> *Archiv für klin. Chir.* 1893, vol. xlv. p. 490.

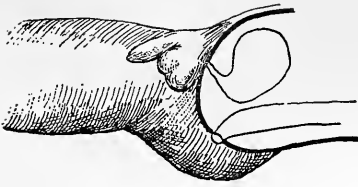

FIG. 107.—NORMAL RECTUM

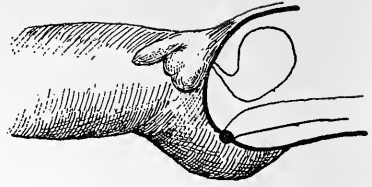

FIG. 108.—ATRESIA ANI

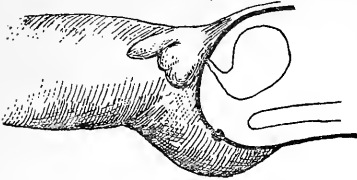

FIG. 109.—ATRESIA ANI WITH PARTIAL ABSENCE OF RECTUM

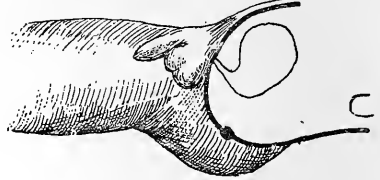

FIG. 110.—ATRESIA ANI WITH COMPLETE ABSENCE OF RECTUM

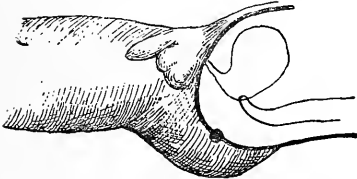

FIG. 111.—ATRESIA ANI WITH FISTULOUS COMMUNICATION WITH THE BLADDER

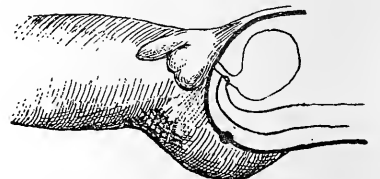

FIG. 112.—ATRESIA ANI WITH FISTULOUS COMMUNICATION WITH THE URETHRA

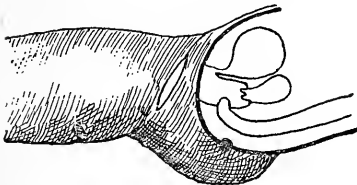

FIG. 113.—ATRESIA ANI WITH FISTULOUS COMMUNICATION WITH THE VAGINA

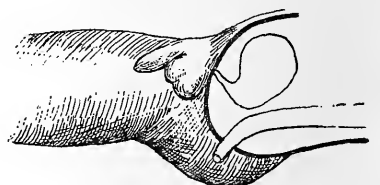

FIG. 114.—ATRESIA ANI WITH FISTULOUS COMMUNICATION WITH THE EXTERIOR, EITHER IN FRONT, BEHIND, OR AT THE SIDE OF THE NORMAL POSITION

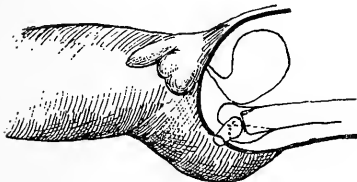

FIG. 115.—ANAL CUL-DE-SAC WITH MEMBRANOUS PARTITION

The rectal cul-de-sac may lie to one side of the anal

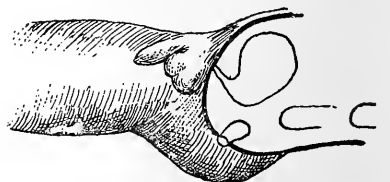

FIG. 116.—ANAL CUL-DE-SAC WITH ABSENCE OF RECTUM, EITHER PARTIAL OR COMPLETE

FIGS. 107-117. - DIAGRAMMATIC REPRESENTATION OF MALFORMATIONS OF THE ANUS AND RECTUM



go to form the normal state. To what the original cessation of growth is due is unknown. The cause, whatever it is, is as likely to be in the ovum as it proceeds from the ovary, as it is to be the result of any one of the innumerable influences brought to bear upon it in the process of development within the uterus.

In order to simplify the description of the commoner forms of malformation met with, and to present them in a more impressive shape, I have made a series of diagrams which must, however, be taken as indicating general types rather than exact pictures of what may be found in the class of cases which they are intended to illustrate.

These diagrams may therefore be taken to represent the usual classification of malformations now adopted.

I. The simplest malformation is that of atresia of the anus (fig. 108). The rectum is fully developed, and also the anal cul-de-sac, but the orifice of the anus itself is occluded by a membrane.

II. In addition to the anal occlusion, there is also absence of the anal cul-de-sac (fig. 109). To this may be added more or less deficiency in the development of the rectum, amounting in some cases to complete absence (fig. 110).

III. There is neither anus nor an anal cul-de-sac, and the rectum terminates by a fistula of variable dimensions as to length and capacity, opening either into the bladder (fig. 111), or into the urethra (fig. 112), or into the vagina (fig. 113), or into some part of the perineum, scrotum, or buttocks (fig. 114) by one or more openings.

IV. Both rectal and anal portions of the canal may be perfectly developed, but the septum which separates the two remains intact. Several varieties of this may exist. If the normal axes of the two segments are maintained, the septum exists as a transversely disposed membrane between the apex of the one and the termination of the other. But the two cul-de-sacs may occupy a position of lateral apposition, the rectal lying in front, behind, or on one side of the anal (fig. 115).

V. The anal portion may be perfectly developed, but there may exist partial or complete absence of the rectum (fig. 116).

To these five classes must be added other cases of infrequent and rare occurrence which from time to time are recorded. Such for instance as the case recorded by Croft,<sup>1</sup> where, at the dissection after death, a scarcely pervious canal was detected by which the rectum terminated in the uterus. Also the cases of Cruveillier and Morgan quoted by Kelsey.<sup>2</sup> In the case reported by the former, a fistulous communication ran from the rectum subcutaneously in the scrotal *raphé* and terminated at the glans penis. While in two cases reported by the latter, a broad thick band passed in the one case from the tip of the coccyx to the median *raphé* of the scrotum; and in the other, from the median *raphé* of the perineum in front to the depression between the buttocks posteriorly. These, however, and other like cases are interesting, but too rare to require more than a passing notice.

When an interval of some extent exists between the rectal cul-de-sac and the anus or the anal cul-de-sac, it is always probable that the rectal segment is completely surrounded by peritoneum. This fact is of importance in considering the question of operation, and will be referred to again.

**Symptoms.**—In those cases where there is no outlet for the meconium, the discovery is soon made by the mother or the nurse, either that there is visibly something defective with the child's anus, or that while the parts appear normal it passes nothing, refuses to take nourishment, and probably vomits what it does take. In the course of a day or two the abdomen commences to swell, and the child appears to be ill.

The existence of fistulous communication with any part of the genito-urinary system soon becomes manifest by the passage of the meconium through either the urethra or the vagina. In the case of fistulæ elsewhere, the true nature of the case is soon detected. To what extent other symptoms may arise, irrespective of the abnormal discharge, will depend upon the calibre of the fistula. Should this be narrow enough to act as a source of obstruction, vomiting and abdominal distension may soon appear. On the other hand, should the

<sup>1</sup> *Trans. Path. Soc. Lond.* 1868, vol. xix. p. 291.

<sup>2</sup> *Diseases of the Rectum*, p. 34.

passage be free enough, little trouble need be anticipated so long as the meconium remains thin and fluid. As, however, the meconium becomes more truly faecal and the faeces assume a solid consistency, urinary troubles rapidly arise in those cases where the communication exists between the rectum and the bladder or urethra.

**Diagnosis.**—As a rule very little difficulty is experienced in detecting the general nature of the case, although the exact form of malformation present may not be so easily determined. The cases likely to mislead are those where an anal cul-de-sac exists, and where the early symptoms are not severe. I know of such an instance where it was mistakenly assumed that the child's indisposition was due to gastric disturbance, and the mother was told to return for advice if the child did not improve. I saw it two days after this advice was given, and found that a catheter passed into the rectum was stopped about an inch and a half from the anal orifice.

The simple statement that the child has not passed meconium, although the other symptoms may be slight, and even absent, should be a sufficient indication for the practitioner to make a careful and systematic examination of the rectum either with the finger or by the introduction of a catheter.

In many of these cases there is evidence of some lack of development of the pelvis, so that it appears small when compared with other parts of the body; and the tuber ischii are observed to be abnormally close together. Such defects, or rather deficiency in the growth of the pelvis, indicate a like deficiency in the development of the intrapelvic viscera; hence, when this condition is at all marked, it may be taken as indicating partial or complete absence of the rectum.

The cases difficult to diagnose are those where the rectal cul-de-sac ends at some distance above the apex of the anal cul-de-sac or the occluded anus. In these it is not possible to feel any bulging or impulse in applying the fingers to the parts below when the child cries, or when pressure is made by the hand upon the abdomen. On the other hand the conveyance of such impressions is significant of a thin septum between the contents of the bowel above and the

exterior. In the case of females some assistance may be obtained by digital examination of the vagina.

**Prognosis.**—In considering the future of these cases it is necessary in the first place to deal with them independently of treatment, and in the second, with the prospects held out by operation.

It need hardly be said that little or no hope exists in those cases where there is complete obstruction. Such remarkable instances as those recorded respectively by Cripps<sup>1</sup> and by Mercier<sup>2</sup> are too exceptional to admit of having any weight in mitigating the usual forecast of a rapidly fatal result. In the former case the child lived and kept quite well for thirty days. Three or four times every day she vomited fæcal matter. In the latter case, a well-nourished girl aged 13 years evacuated fæcal matter by vomiting every fourth or fifth day.

The prognosis in regard to fistulous communications is not so hopelessly bad as in the case of total obstruction. Not a few cases are on record where patients born with this type of malformation have lived for years. Much depends upon the situation of the fistula, and the readiness with which the fæces make their exit through it. When the communication is with the bladder or the urethra, cystitis is sooner or later set up, and the child dies of this or of obstruction. There are even exceptions to this rule, and a remarkable case reported by F. Page<sup>3</sup> illustrates how nature can sometimes overcome these difficulties. Immediately after birth, urine and fæces were passed by the urethra, the anus being imperforate. At the age of 10 years the urethra became blocked with hardened fæces, and relief was obtained by an incision into it immediately in front of the scrotum. The result was a permanent fistula, through which the patient continued to pass urine and fæces. He was in the habit of taking a laxative daily, and had to squeeze the fæces through the fistula with his fingers. From time to time the urethral fistula became blocked, and then everything was passed by the meatus. When last seen, this man had reached the age of

<sup>1</sup> *Trans. Path. Soc. Lond.* 1880, vol. xxxi. p. 112.

<sup>2</sup> Cripps, *Diseases of the Rectum*, p. 28.

<sup>3</sup> *Brit. Med. Journ.* 1888, vol. ii. p. 875.

54. Kelsey<sup>1</sup> quotes Gross as recording the case of a man who lived to the age of 30, and also cites Bodenhamer as giving several others in which children have lived three or four years. The same author refers to Rowan's case, where defecation took place through the penis for two months without causing any signs of irritation, though the child was several months old.

The cases in which prognosis is most favourable are those where the communication is between the rectum and the vagina. It usually happens that the orifice of the fistula is situated near the vaginal entrance. In all the cases, twelve in number, of Cripps's series of 100, the opening was in the posterior wall, just behind the hymen. If the orifice and the fistula are of sufficient size to allow of a ready escape of the fæces, the child may live for years and even reach old age, with nothing more to complain of than the inconvenience associated with the abnormal fæcal outlet. In a case recorded by Byron,<sup>2</sup> the fæces were completely retained by a sphincter in the vagina until the rectum became filled with fæcal material. Cooper<sup>3</sup> quotes two cases, one by Abel of a woman aged 20, in whom the fæces could be held and periodically evacuated without trouble; and another, by Ricord, of a woman aged 22, who could similarly retain her fæces and defecate without trouble. In the latter case the woman had been married for three years, and the malformation had not been discovered by her husband. Ball<sup>4</sup> records the case of a woman who was the mother of six children. The anus opened into the lower portion of the vagina, and was so far provided with a sphincter that the top of the finger when introduced into the rectum was tightly grasped. She never suffered from the slightest inconvenience.

In most cases where symptoms of obstruction set in, death results from exhaustion; there is, however, the possibility of the distended bowel rupturing. In a case recorded by Fuller,<sup>5</sup> the abdomen on the fifth day after birth was enormously distended, and tympanitic. After death it was found that the

<sup>1</sup> *Diseases of the Rectum*, p. 36.

<sup>2</sup> *New York Med. Journ.* 1894, vol. lix. p. 247.

<sup>3</sup> *Diseases of the Rectum*, p. 54.

<sup>4</sup> *Ibid.*, p. 44.

<sup>5</sup> *Lancet*, 1894, vol. i. p. 1499.

rectum above the septum presented about its centre a hole large enough to admit three fingers. The edges of the orifice were sloughy, suggesting a rupture some time before death. Meconium was found extravasated into the peritoneal cavity.

**Prognosis in regard to operation.**—It naturally follows that the simpler the operation requisite to deal efficiently with the malformation, the more likely is treatment to be successful. Thus it is found that the best results follow the treatment of vaginal fistula, while the worst are those in which an artificial anus is made either in the inguinal region or in the loin. In neither of these classes of case, however, is it right to attribute success or failure altogether to the operation; for in the one class the type of the malformation is the least serious, while in the other it ranks among the most fatal. The prospect of success or failure in regard to the nature of the operation performed is best seen by a reference to the tables compiled respectively by Cripps and by Anders.

*Results of operations in Cripps's series of 100 cases.*

	Lived	Died
1. Colon opened in the groin . . . . .	16	5 11
2. Colon opened in the loin . . . . .	3	1 2
3. Puncture . . . . .	17	3 14
4. Coccyx resected . . . . .	8	3 5
5. Perineal incision or dissection . . . . .	39	25 14
6. Communication between rectum and vagina	14	13 1
7. Miscellaneous . . . . .	3	0 3
	<u>100</u>	<u>50 50</u>

*Results of operations in Anders's series of 100 cases.*

	Lived	Died
1. Colon opened in groin . . . . .	8	4 4
2. Colon opened in loin . . . . .	3	1 2
3. Littre's . . . . .	10	5 5
4. Puncture . . . . .	4	2 2
5. Incision . . . . .	27	18 9
6. Proctoplasty (dissection) . . . . .	44	31 13
7. Non-operable . . . . .	3	2 1
8. Miscellaneous . . . . .	1	1 0
	<u>100</u>	<u>64 36</u>

It need hardly be pointed out that a just estimate of the value to be attached to these tables can only be formed

by a careful analysis of the cases comprised in them. For the extremely variable nature of the malformations is such that one particular operation might prove more frequently successful in one type than in another. The various tables given by Anders admit of this investigation, but it would occupy too much space to introduce them or to attempt to summarise them here.

As regards the remote results of operation, numerous cases are on record to show that life has been prolonged for months and years. As illustrative of comparative longevity of life, the following are abstracted from Curling's series of 100 cases.

*Longevity after operation.*

1. Lived 43 years; died of other troubles. *Operation.*—Colotomy in groin.
2. Alive and well at 43 years. *Operation.*—Colotomy in groin.
3. Alive and well at 46 years. *Operation.*—Colotomy in groin.
4. Alive and well at 36 years. *Operation.*—Cul-de-sac reached and drawn down into the perineum, and artificial anus established behind the seat of natural anus.
5. Alive and well at 21 years. *Operation.*—Incision and puncture, and gut reached.

Among the more recently published cases are the following. Ball<sup>1</sup> records the case of a medical man operated upon at birth for imperforate anus. A case by Moullin,<sup>2</sup> where the bowel was opened in the left inguinal region within twenty-four hours of birth. The child lived for six months, and then contracted measles, from which it died. At the post mortem the rectum was found to open by a very narrow channel into the prostatic portion of the urethra. In a case recorded by Stephen Paget,<sup>3</sup> the author was enabled to effect an opening through the perineum by passing a director through the bowel from above after performing colotomy. The child lived five weeks, and great difficulty was encountered in keeping the rectum dilated. In my own case described below, a sigmoid anus was made, and a subsequent communication established with the anal cul-de-sac by a director passed through the artificial anus. The child lived for about seven months, and then contracted scarlet fever, from which it

<sup>1</sup> *Diseases of the Rectum*, p. 42.

<sup>2</sup> *Trans. Path. Soc. Lond.* 1886, vol. xxxvii. p. 260.

<sup>3</sup> *Ibid.* 1890, vol. xli. p. 143.

died. As in Paget's case, great difficulty existed in preventing the contraction at the line of communication. In a case recorded by Conant,<sup>1</sup> the abdomen was opened, and by the aid of digital manipulation within the pelvis, it was found possible to successfully guide a trocar into the distended rectum. The child lived for three months, and then died of entero-colitis.

---

## CHAPTER LXXX

### MALFORMATIONS (*continued*). TREATMENT. CONGENITAL STRICTURE. DIVERTICULUM

**Treatment.**—Clinically these malformations present themselves under two distinct classes—those where the nature of the abnormality is evident, and those where it is not. In discussing, therefore, the treatment, it is right to consider it from this twofold aspect; for while it serves admirably the purpose of the pathologist to classify the various malformations which may be found, it is not of much practical service to the surgeon, who in many cases is forced to perform his operation before discovering the nature of the deformity for which he does it.

When a distinct bulging exists or an impulse is distinctly felt at the seat of an occluded anus, or at the apex of an anal cul-de-sac, the surgeon has little difficulty in deciding that the proper course to pursue is to make a small crucial or single incision into the projecting mass and allow the escape of the pent-up meconium. Later, if considered necessary, the opening thus made may be dilated to the required extent.

When meconium is passed by some abnormal channel, the treatment will be determined by the troubles caused. Thus, if it is possible to dilate the fistula sufficiently to allow of a free and unobstructed exit of the meconium, no immediate danger need be anticipated; but if such dilatation is not possible, and obstruction, if not present, certain to appear sooner or later, then an operation which otherwise might with advantage have been delayed must be performed.

<sup>1</sup> *Boston Med. and Surg. Reporter*, 1892, vol. cxxvi. p. 287.



If the meconium passes through the urethra, the rectal communication is either with this canal or with the bladder. A dissection should be made in the median line of the perineum. If the fistula is recto-urethral, it will be reached and found possible to disconnect it. The bowel should then be brought down and fixed in the perineum. Should the result of the dissection prove negative, it is then probable that the fistula is recto-vesical, and nothing but a sigmoid anus will give the requisite relief.

If the meconium come through the vulva, a vaginal fistula is present. Regarding the treatment of this condition some difference of opinion exists. If a well-marked sphincter guards the orifice of the vaginal anus, it may be well to leave the case alone rather than run the risk of losing, by dissection and transplantation, this power of control. If operation is attempted, the most successful appears to be that devised and carried out by Rizzoli. Its main object is to dissect back the rectum, and preserve the tissues around the vaginal orifice which may act as a sphincter. The operation is commenced by an incision carried from the lower margin of the vaginal anus backwards towards the coccyx. The rectum is then detached, care being taken not to open the bowel, and the vaginal orifice stitched into the place where the normal anus should be situated. Deep sutures are inserted to close in the posterior part of the vaginal wall, and so form a recto-vaginal septum.

If there is no immediate urgency these plastic operations may with advantage be left until the child is older and therefore better fitted for operation. Swaine<sup>1</sup> very successfully treated a child 6 years old, which had passed all its fæces by a vaginal anus. On account of much abdominal swelling, a fæcal fistula was formed in the groin. After an interval, the rectum was dissected from the vagina and brought down to the perineum and a true anus established. The fistula then healed.

When external fistulæ exist either in the perineum or scrotum, there may not be need for immediate interference. It must be remembered that in so young a class of patients all delay is valuable with a view to the safety and success of

<sup>1</sup> *Lancet*, 1891, vol. i. p. 143.

any operation, as long as it does not entail a less suitable state of the child's general condition. If on the other hand the nature of the malformation involves increasing gravity in the condition of the child, the sooner operation is performed the better. Should the fistulæ in this class of cases not suffice to allow of a free discharge, they should be either enlarged or a perineal dissection made to obtain the more dilated portion of the bowel.

What treatment is to be adopted when the surgeon has no distinct guidance as to the type of the malformation present? To very many cases which present themselves for treatment this question is applicable.

The usually accepted course to pursue is to make an incision backwards from the normal seat of the anus to the coccyx, removing this if thought necessary, and continuing to extend the incision deeply and in the direction of the concavity of the sacrum. If a reasonable dissection of this nature fails to reach the bowel, there is nothing for it but to make an artificial anus either in the groin or in the loin. If on the other hand the rectal cul-de-sac is reached, an endeavour should be made to bring the rectal outlet to the surface and stitch it there. In cases where this involves much tension on the bowel, the coccyx may be removed, and so the distance to the surface shortened. While an incision into the bowel will for the time relieve the child, it soon becomes little more than a troublesome fæcal fistula; hence the advantage attached to fixation of the rectal orifice to the skin surface.

As regards searching for the bowel by dissection in the perineum, it should be remembered that in cases where there is deficiency of development of the pelvis as a whole, there is the greater probability that the rectum may be entirely absent or occupying a high limit.

When it is decided to open the bowel, should a colostomy be performed or an artificial anus made? From my own experience I am disposed to favour the formation of an artificial anus, and for this reason, that the bowel of an infant is so thin, and more particularly so if it has been distended, that it is difficult to accurately stitch it to the parietal wound; and if, as is usually the case, it must be opened at once, the

thin meconium is liable to contaminate the surface of the bowel and find its way into the peritoneal cavity. If on the other hand a loop of intestine is withdrawn and secured by a rod of some kind passed transversely through the mesentery, and a drainage tube fixed into the upper end of the loop in such a way that the meconium can only escape through it, there is little or no danger of septic infection. It has also the further great advantage that a much shorter time is required to make an anus than to make a fistula such as results from a colostomy. The only objection which the method has is the difficulty of closing the anus as compared with the fistula, if such be required. It is more than likely, however, that if it is possible for the patient to live for any length of time, he will be more likely to do so with a good artificial anus than with one which has been subsequently opened up in the perineum, and which shows a constant tendency to contract and close.

It is usual to operate in the left groin with the object of opening the sigmoid flexure. In these cases of defective development, however, it not infrequently happens that the sigmoid does not lie in its normal position. If therefore this part of the bowel cannot be found, the surgeon must either secure any distended loop which presents, or else close the original wound and open in the right groin.

The question is often raised whether, after the bowel is opened in the groin, any attempt should at once be made to open up the perineal passage by a bougie or director passed in and downwards through the bowel orifice. Such treatment has been adopted and with success, as already instanced by Paget's case, where the child lived for five weeks afterwards. Possibly such a course is right when the infant's condition admits of the prolongation of the operation, and when it is felt that the apex of the bougie is at no great distance from the normal seat of the anus or the anal cul-de-sac. But for this latter condition there is the danger that the rectal cul-de-sac may be surrounded by peritoneum, and so its perforation lead to a communication with the general peritoneal cavity. The one advantage of attempting this method of establishing a normal channel at the first operation rather than delaying it for future treatment, is the ease with which it is

possible to close up the opening in the colon. The difficulty later would not exist so much with a colostomy; but with an artificial anus, an operation entailing considerable risk would have to be added to what so far may have proved successful.

Nothing has as yet been said of the treatment of many of these cases by puncture or the use of the trocar and canula. The practice was much in vogue many years ago, but experience has sufficiently shown that it is one of the most dangerous methods to employ. A reference to Cripps's and Anders's statistics of operations (see p. 662) will sufficiently indicate how fatal this method of operating has been in comparison with others. The fatality in connection with it is largely dependent upon the fact that there is nothing to guide the operator in avoiding the injury which he is liable to inflict. The trocar may be passed directly into the peritoneal cavity, or traverse the rectal cul-de-sac and then enter the peritoneal cavity. In illustration of such accidents, two cases may be cited, one recorded by Cripps<sup>1</sup> and the other by J. J. Clarke.<sup>2</sup> In the case of the former, the puncture had passed into the apex of the peritoneal pouch upwards, parallel to the bowel; peritonitis ensued, from which the child died. In the case of the latter, the trocar entered the peritoneal cavity by passing through the lowest extremity of the rectum. Death, however, ensued from hæmorrhage, the result apparently of injury to the sacra-media artery. At the necropsy, meconium was found in the peritoneal cavity.

Other methods of treatment are sometimes adopted, such for instance as that employed in Conant's case. The abdomen was opened in the left linea semilunaris. Distended bowel was detected extending towards the perineal incision. It seemed about a quarter of an inch from this incision, which had been previously made in search for the bowel. By the guidance of one finger in the abdomen, a trocar was successfully thrust through the perineal wound into the distended gut. Five ounces of meconium passed by the canula. The abdominal wound was closed, and the canula fastened in by

<sup>1</sup> *Trans. Path. Soc. Lond.* vol. xxxi. p. 112.

<sup>2</sup> *Lancet*, 1891, vol. ii. p. 1277.

plaster. The child improved, but died three months after from entero-colitis.

CASE CXV.—*Anal cul-de-sac, rectum imperforate: sigmoid anus: subsequent opening into rectum from perineum. Death in seven months from scarlet fever.*

The child was born on Thursday, April 25. On Friday, May 6 (eleven days after birth), it was brought to the Victoria Infirmary, Glasgow. It was stated that it had passed nothing by the anus. Castor oil had been given without effect and enemas had been tried, but the fluid was found to return immediately. It had never vomited. On examining the abdomen much distension was observed. A catheter introduced into the anus did not pass for more than an inch. The child was emaciated and suffered from double purulent ophthalmia. The pelvis appeared unduly small, and the ischial tuberosities abnormally close together.

*Operation.*—After chloroform was administered, the anal cul-de-sac was carefully examined, but no bulging of bowel could be detected. A tenotomy knife was thrust in for about an inch, and an incision carried backwards towards the sacrum. Nothing, however, was detected. A left sigmoid anus was then made. It was intended at first not to open the bowel, but owing to the failure of respiration, and the critical state which the child seemed to be in, an opening was made into the loop, when a large quantity of gas at once escaped, and the child's condition immediately began to improve and no further trouble occurred.

On July 18, about ten weeks after the first operation, a bougie was passed down the rectum from the artificial anus. The point was felt comparatively near the apex of the anal cul-de-sac, and an incision made upon it sufficiently large to admit of an indiarubber tube being inserted. This was sufficiently long to admit of being passed through the rectum and out at the sigmoid anus, and the two free ends fastened together.

On November 8 the artificial line of communication had contracted into such a tight stricture that it was necessary to divide it. A vulcanite rectal pessary was tied in, and this appeared to be having a beneficial effect, when the child contracted scarlet fever and died. (A. Ernest Maylard, 'Glasgow Med. Journ.' 1896, No. 2, vol. xlv. p. 120.)

**Congenital stricture.**—The term 'congenital stricture' implies not necessarily that a stricture existed at birth, only that the conditions involving its subsequent development were present. These cases are usually included under those just described, inasmuch as they are the result either of defective development of the anal or lower rectal portion of the canal, or of treatment employed in remedying some of the more serious obstructive malformations. When arising as the result of incomplete development, the stricture takes the form either of a canal which has remained too narrow for

the purposes required; or the septum which normally divides the anal and rectal portions of the gut has only been imperfectly removed, so that either a simple orifice exists in it, or a part remains in the form of a valve. According to Trélat,<sup>1</sup> who records having seen five instances of this valvular form of obstruction, the usual seat of the stricture is about five centimetres from the anus. The stricture may escape notice for many years; and not until age lessens the general elasticity of the tissues, and the fæces become larger and more solid, do symptoms of obstruction and difficulty in defecation arise. These symptoms differ in no respect from those already described as arising from innocent or non-malignant stenosis; abscess and fistulæ may result; or ulceration and fæcal extravasation may lead to periproctitis.

Strictures which arise as the result of operations performed to open up the continuity of the canal in cases of imperforate anus or rectum, or as the result of transplanting the rectum from the vagina or the urethra to the perineum, are often among the most troublesome. They are essentially cicatricial strictures and therefore extremely tight. Good instances of these are seen in the case narrated above in full, and in Paget's, also quoted above. The simplest form of cicatricial stricture arising from operation is such as may be met with after incision for atresia ani. In the case recorded by Ball<sup>2</sup> of a medical man who had been operated upon at birth for imperforate anus, a comparatively slight constriction was felt just within the anus, through which the finger readily passed.

Little need be said regarding the treatment of these cases; for if simple dilatation or incision of the stricture is not sufficient, it must be treated on the lines already laid down for stricture arising from other non-malignant causes.

**Diverticulum.**—True diverticula of the rectum are extremely rare. I have only met with four recorded instances. In 1873 Hulke<sup>3</sup> published a case. The diverticulum was situated on the side of the rectum, running parallel with it. It was large enough to admit the finger easily, and was several inches in

<sup>1</sup> Kelsey, *Annual of the Universal Medical Sciences*, 1888, vol. ii. p. 148.

<sup>2</sup> *Diseases of the Rectum*, p. 43.

<sup>3</sup> *Trans. Path. Soc. Lond.* 1873, vol. xxiv. p. 87.

length. In structure it possessed a mucous lining and a muscular coat.

In 1887 Ball<sup>1</sup> published a case in his work upon 'Diseases of the Rectum.' Strangely, the author introduces the case as a unique one in his chapter on Malformations, but in a short chapter at the end of the book on the subject of diverticula no notice is taken of it. The case was that of a medical man who developed a swelling at the root of the penis and deep in the scrotum. He had suffered from pain while the bowels were being moved. When the rectum was examined, a diverticulum was detected passing off in the direction of the situation of the abscess, that is to say, forwards towards the urethra. The patient had suffered at birth from atresia of the anus, and slight constriction of the anal orifice had resulted. It is stated that after the abscess was opened and the membranous stricture dilated, the diverticulum became closed, so that the patient ultimately was cured. The want of some more exact evidence than that which the narration of the case affords, raises some doubt as to its being one of true diverticulum. The presence of a stricture, and a fetid abscess in the perineum in communication with the bowel just above the stricture, strongly suggests that the one has been the result of the other, and that an ordinary fistula *in ano* was in process of formation. Possibly some such opinion existed in the mind of the author, and so it was not introduced as an illustration of the condition in the short chapter especially devoted to the subject.

In 1888 Maas<sup>2</sup> reported a remarkable case of an immense diverticulum. The patient was a boy aged 14. Shortly after birth the abdomen began to swell, and continued to increase in size as he grew older. He remained well until the age of 13. The abdominal distension then commenced to cause dyspnoea and palpitation. The boy died suddenly, when at the post mortem an immense diverticulum was found arising from the upper part of the rectum. It contained gas and fourteen litres of thin faeces.

In 1889 Terrier<sup>3</sup> recorded an interesting case in which the diverticulum was successfully excised. The patient had

<sup>1</sup> P. 42.

<sup>2</sup> Kelsey, *Annual of the Universal Medical Sciences*, 1889, vol. iii. D—2.

<sup>3</sup> *Revue de Chirurgie*, 1889, vol. ix. p. 929.

suffered during life from a constant sense of weight in the rectum. A fulness was observed externally in the right ischio-rectal fossa ; and on introducing the finger it could be made to enter a contracted orifice which led into a diverticulum on the right side, filled with fæces. The rectum itself was dilated. The diverticulum was removed, and the dilated bowel also narrowed. The patient made a good and uninterrupted recovery.

---

## CHAPTER LXXXI

### NEUROSES. EXTERNAL INFLUENCES

WHILE much has been written upon the subject of neurotic affections of the rectum, most men appear practically to have seen but little of them. Judging from the literature on the subject, the object of many writers appears to be to refute rather than to support the theory that such affections exist. Van Buren,<sup>1</sup> in an exhaustive article upon what he terms 'phantom strictures,' introduces numerous instances in which patients were led to believe, either through their own aberrant nervous condition or as the result of ignorant and groundless suggestion, that rectal trouble existed, and were treated accordingly. Indeed, many years ago, supposed strictures of the rectum seemed a sort of fashionable complaint, for which the systematic passage of bougies was considered the proper treatment.

In addition to these imaginative cases, there is little doubt that a great many cases of so-called neuralgia of the rectum have their explanation in the existence of some organic lesion. Either the pain is set up by a small ulcer or abrasion, in the floor of which a sensitive nerve filament is exposed ; or the pain is excited reflexly by disease situated in some neighbouring organ or tissue. If a case is to be considered one of true neuralgia, a careful examination should reveal no lesion to account for the pain, nor should the patient's sufferings be in any way affected by defecation.

The class of patients supposed to be the subject of these

<sup>1</sup> *American Journal of the Medical Sciences*, 1879, N.S. vol. lxxviii. p. 336.



neurotic affections are usually females of feeble constitution and of a more or less depressed state of the nervous system. The pains attending them are described as often excessively acute and lancinating and sometimes periodical in their mode of seizure. Allingham,<sup>1</sup> who is largely quoted as a believer in rectal neuralgia, mentions having noticed the attack follow direct exposure to wet and cold, as after sitting upon damp grass.

In treating the condition attention should be devoted to the general health, and such remedies and directions given as would be considered expedient and suitable in patients that possess in all probability an irritable and neurotic temperament. In a very obstinate case of nervous or hysterical rectum reported by Mathews,<sup>2</sup> where the patient, a young lady, suffered from attacks of 'sharp, quick, lancinating, terrible pain just within the rectum, lasting for a few minutes to several hours,' the symptoms subsided with enemata of cold water when all other means had failed. Allingham's line of treatment is first to unload and put the abdominal viscera into condition, then give tonics such as iron, quinine, and strychnia, with morphia hypodermically for the pain. While some cases improve rapidly under treatment, others appear intractable, the attacks of pain recurring from time to time.

**External influences.**—The rectum, like all other parts of the intestinal canal, is liable to be pressed upon, displaced, distorted or opened into by agencies acting from without, and primarily unconnected with the bowel.

Pressure may result from an enlarged prostate, or from an abscess connected with the prostate : from tumours growing from the uterus, ovary, bladder, or sacrum. Displacement or distortion may be due to similar causes, or to inflammatory action, as seen in pelvic cellulitis. Abscesses, both acute and chronic, may burst into the rectum, giving rise to the discharge of pus and blood, more or less continuous according to the nature of the primary disease. Chronic abscesses are such as arise from caries of the bones of the pelvis ; caries of the spine producing a psoas abscess ; abscess in connection with hip joint disease. Acute abscesses may be the result of pelvic cellulitis, pelvic appendicitis, prostatic abscess from gonorrhœa, &c.

<sup>1</sup> *Diseases of the Rectum*, p. 324.

<sup>2</sup> *Ibid.* p. 257.

In illustration of some of these causes the following instances may be cited.

Van Buren<sup>1</sup> records a case of uterine fibroma which produced symptoms of obstruction. The case was that of a young lady who could not relieve her bowels whilst sitting in the usual position, and in order to do so she had been compelled to resort to the use of a bed-pan, taking an enema and then lying upon her back. A digital examination of the rectum, made while she was in the sitting position, revealed the presence of a globular tumour which became forced backwards into the hollow of the sacrum, so as to completely obstruct the passage through the rectum. The tumour subsequently proved to be a fibroma attached to the posterior wall of the uterus. A somewhat similar case is recorded by Sydney Jones,<sup>2</sup> in which a large uterine fibroid pressed upon the rectum and caused serious interference with the action of the bowels.

When rectal troubles arise in connection with pelvic cellulitis, the inflammation leads either to the formation of an acute abscess, or to a more chronic process involving much inflammatory thickening and contraction. In the former case the abscess may burst into the bowel, and produces for the time no more serious rectal symptoms than the discharge of a quantity of blood and pus which ceases as the abscess cavity closes and heals. In the latter case, however, the greater slowness of the process may result in the formation of adhesions and fibrous bands which compress, drag upon, or displace the bowel from its usual position, and lessen its normal function as a more or less uniformly distensible canal. The sequel to these influences is in some cases a well-marked fibrous stricture; for while the cause is at first situated external to the bowel, its parietes soon become directly involved, and changes take place in it which lead to a condition indistinguishable from any arising primarily within the gut wall. Cripps<sup>3</sup> describes the case of a woman who a month after being seized with pelvic cellulitis had a discharge of blood and pus from the rectum. This continued rather profusely for some weeks, when she began to have difficulties

<sup>1</sup> *American Journal of the Medical Sciences*, 1879, N.S. vol. lxxviii. p. 336.

<sup>2</sup> *Trans. Path. Soc. Lond.* 1887, vol. xxxviii. p. 247.

<sup>3</sup> *Ibid.* 1886, vol. xxxvii. p. 255.

in defecation. The symptoms continued and increased until a year later, when a tight stricture could be felt, starting about three inches up from the anus. She died about a month later, when a well-marked fibrous stricture was observed, involving about six inches of the bowel. At the bottom of Douglas's pouch there was a well-marked cicatrix, apparently indicating the site of an old abscess cavity in the fascia between the peritoneum and the rectum. The rectum opposite this point appeared to have been dragged upon and drawn towards the cicatrix mentioned. The following case, which is given more fully, is interesting as showing to what an extreme degree the rectum may be involved in this affection.

CASE CXVI.—*Double stricture of the rectum from pelvic cellulitis: acute obstruction. Death.*

A woman aged 50 had suffered constantly from pelvic and rectal pain, with increasing difficulty in defecation ever since an attack of pelvic cellulitis four years previously. For the last year and a half she had been troubled with attacks of diarrhœa, and the occasional passage of blood. On examination of the rectum a mass of cartilaginous firmness was felt connected with the uterus behind, and completely blocking the bowel by pressing it against the sacrum. Relief was afforded by the passage of a catheter through the stricture, but the sensation conveyed was always that a second one existed higher up. The patient refused to have an artificial anus made, and lived a miserable existence for two years, finally having an attack of acute obstruction, from which, however, she recovered, only to die shortly after from uræmia. At the post mortem, the anterior surface of the uterus and the bladder were free from any exudation; but both ovaries and broad ligaments, the rectum and Douglas's pouch were solidly embedded and all firmly cemented to the sacrum and coccyx. About an inch and a half above the first seat of obstruction a second was discovered, caused by a distinct band which had twisted the bowel on itself and bound it firmly down to the top of the sacrum. In the space, between the uterus and rectum, there was an abscess cavity containing black sloughy tissue. The existence of this had not been detected during life. (Kelsey, 'New York Med. Journ.' 1887, vol. xlv. p. 435.)

Abscess arising in connection with the prostate may be either of an acute or chronic character. When acute, it is frequently the result of gonorrhœa, and causes not only difficult but painful defecation. The urethra is also liable to be pressed upon, so that urinary trouble is often asso-

ciated with the rectal. Henry Smith<sup>1</sup> narrates the case of a man aged 25 years who had passed nothing for a week, and was in continual suffering. A fluctuating swelling was detected in front of the bowel, which it almost occluded. When incised pus escaped and all symptoms subsided.

Tumours of the bladder capable of producing obstruction are rare, but cases have been recorded. Hurry Fenwick<sup>2</sup> quotes a case of Obre's in which a large hydatid situated in the meso-rectum led to death from obstruction. The pressure was so great that it produced sloughing of the coats of the bowel at the part. Other cases of hydatids in the pelvis are referred to, where difficulty in both defecation and micturition were present.

---

## CHAPTER LXXXII

### OPERATIONS

1. THE ADMINISTRATION OF COPIOUS FLUID ENEMATA.
2. THE PASSAGE OF BOUGIES, &C.
3. INTERNAL PROCTOTOMY.
4. EXTERNAL (LINEAR OR POSTERIOR) PROCTOTOMY.
5. PROCTECTOMY—
  - a. PERINEAL
  - b. SACRAL OR POSTERIOR
  - c. VAGINAL.
6. PROCTORRHAPHY.
7. PROCTOPEXY.
8. PROCTOPLASTY.
9. RECTAL ELECTROLYSIS.
10. RECTAL CAUTERISATION.

MANY of the operations upon the rectum are of limited application, being employed for some one special condition of the part itself; hence, as contrasted with the œsophagus, the stomach and the intestines, the operations are mostly described at the end of the disease, of which they constitute the appropriate treatment. Thus operations for prolapse and for many malformations are essentially peculiar to the affections, and are

<sup>1</sup> Holmes's *System of Surgery*, 1883, 3rd edit. vol. ii. p. 858.

<sup>2</sup> *Trans. Path. Soc. Lond.* 1891, vol. xlii. p. 210.

applicable as treatment to no other conditions. The operations of proctotomy and proctectomy, on the other hand, are performed for more than one affection, and hence rank in the same category as like operations in other parts of the alimentary tract; they are, in a sense, classical operations, and call for separate treatment.

1. **The administration of copious fluid enemata.**—The object in view may be (1) to excite peristaltic action in the intestines, (2) to empty and cleanse the lower bowel, (3) for purposes of diagnosis. When it is merely desired to excite the bowels to act, the fluid will be best injected by means of a Higginson's syringe, with the patient in the sitting posture over the stool. The sudden and forcible injection of, say, warm soap and water soon evokes a desire to empty the bowel.

If the object is both to empty and cleanse the rectum preliminary to operation, the enema is best administered while the patient is lying on the back with the buttocks slightly raised and resting upon the bed pan. A gum elastic urethral catheter of No. 10 or 12 size, lubricated with vaseline, and having attached to its free end a rubber tube about three feet in length, is gently inserted into the anus, and made to pass as far as possible up the rectum. To the other end of the tube is fixed a filler or funnel. This is held up about two feet above the bed and the fluid allowed to flow in slowly. The object in view is not to excite peristaltic action before the bowel has been well distended, and its mucous folds put more or less on the stretch. By so stretching the part it is much more efficiently cleansed, and any fæcal particles which may be lodged in folds or small recesses, or be unduly adherent to the lining membrane, will be detached and ejected with the outflowing fluid.

When injecting fluid into the rectum for diagnostic purposes, the same precautions should be exercised in not introducing it too quickly or too forcibly. The object may be to ascertain the locality of a stricture either high up in the rectum, or in the colon; to excite peristaltic action too readily or too soon would be to frustrate the object for which the injection was being given.

2. **The passage of bougies &c.**—A bougie is introduced into the rectum either for diagnostic purposes or for treatment.

When with the former object, a large-size one is introduced, in order to detect in the first place whether there is any real obstruction.

For the passage of a bougie any one of the three positions for making a rectal examination may be employed, the lateral, lithotomy, or knee-elbow position. The lateral will frequently prove the most convenient. The patient lies on the left side with one or both knees drawn up. Preferably the rectum should be first emptied by a copious fluid enema. A little oil containing opium or belladonna is injected, to facilitate the passage of the bougie, and to allay any irritability of the rectum. To further ease the introduction of the bougie it should be besmeared with some tenacious lubricant such as Unguentum Hydrargyri. No force should be employed, and as any obstruction is met with the bougie should be withdrawn somewhat, and its direction slightly altered. Independently of any pathological obstruction, it should be remembered that the bougie may catch in one of the folds of the rectum, or impinge upon the promontory of the sacrum, or be caught in the cul-de-sac of an intussusception.

Injuries effected by the introduction of a bougie have already been indicated (see p. 568).

For the kinds of bougies in use, and the cases best suited for their respective application, see p. 595.

For the method of introducing the hand into the rectum, see p. 566.

3. **Internal proctotomy** resembles in all respects internal œsophagotomy and is employed as an operation for the same conditions.

The strictures best suited for the operation are those situated nearer the anal extremity of the gut.

The bowel is previously cleansed as well as the condition will permit. An anæsthetic is administered and the patient placed in the lithotomy position. The anus is forcibly dilated and the lower end of the stricture exposed by a speculum. A probe-pointed straight bistoury is then passed through the stricture, guided either by what is seen through the speculum or by the introduction of the forefinger of the left hand. The knife is then made to cut through the stricture sufficiently deeply to reach the healthy tissues beneath. In some cases

the one incision will be sufficient, in others two or more will be required.

William Allingham,<sup>1</sup> who has practised this operation in a considerable number of cases, usually divides the stricture at four points. Immediately after the incisions he fills the bowel with well-oiled lint or wool for twenty-four hours; and then after its removal introduces a vulcanite tube furnished with a collar to which tapes are attached to keep it in the bowel and prevent it slipping into the rectum. This is worn continuously for some time, and only removed when the bowels act, and when the rectum is washed out with some very dilute Condyl's fluid or thymol.

One of the alleged objections to this operation is the difficulty of incising the stricture with such nicety that while the incisions completely divide the cicatricial tissue they do not enter too deeply into the healthy tissues beneath. Should these healthy tissues be incised too freely, there is the danger of septic infection of the wound, with consequent proctitis or periproctitis.

An essential feature of the operation is the maintenance of dilatation. Unless tubes are constantly worn or introduced for a prolonged period from time to time, recontraction will take place, and a renewal of all the old troubles follow.

4. **External proctotomy.**—This operation is sometimes spoken of as linear or posterior proctotomy, and is employed for opening the rectum for the removal of impacted foreign bodies, tumours, or for the division of strictures, innocent or malignant. It consists in laying open the bowel completely from and including the anus, upwards and backwards towards the coccyx.

The patient is placed in the lithotomy position, and the tissues divided posteriorly by means of the *écraseur*, the galvano-cautery, or the knife.

The former two methods were employed by Verneuil with the object of better checking the hæmorrhage. The knife is, however, now most generally used.

In operating for stricture two methods of using the knife may be employed. In the first the anus and the part of the rectum and tissues behind and below the stricture are cut through with an ordinary scalpel. The lowest part of the

<sup>1</sup> *Diseases of the Rectum*, p. 261.

stricture is thus fully exposed, and its complete division is then proceeded with. In the second method either a sharp-pointed curved bistoury is guided *through* the stricture, and the whole tissues cut in the median line posteriorly; or an ordinary scalpel is used and the same structures divided from without.

In order to check the hæmorrhage which may follow the wound should be tightly packed, the stuffing being removed daily by degrees. The advantage of this operation is the complete drainage which it affords, and hence the little likelihood of those inflammatory complications which sometimes arise when, in the case of stricture, the incisions are carried out wholly within the bowel.

The operation and its results have been carefully considered by Kelsey<sup>1</sup> whose series of collected cases is worthy of attention.

5. **Proctectomy.**—The operation implies partial or complete removal of the rectum for ulceration, stricture, or cancer. It is performed either from below through the perineum (perineal) or from behind through the sacrum (sacral or posterior) or through the vagina (vaginal).

Whichever of these three operations is performed, certain preparations of the patient and of the rectum are requisite before commencing to excise the part. The bowels should be well cleared out by the administration of a good dose of castor oil administered two days before the operation. A second dose should be administered the morning before; and upon the morning of the operation copious enemata of dilute Condé's fluid should be used. Routier<sup>2</sup> adopts a very rigid course. The patient is purged several times before the day of operating with castor oil. About half a drachm of naphthol with an equal quantity of salicylate of magnesia is administered each day and the diet is limited exclusively to milk. By this process of preparation, it is said, the stools become inodorous and resemble those of a child.

Where, from the tightness of the stricture, or from the obstructiveness of the growth, it is found impossible to get the bowel well emptied above the seat of disease, an artificial

<sup>1</sup> *Diseases of the Rectum*, p. 209.

<sup>2</sup> *Revue de Chirurgie*, 1889, vol. ix. p. 971.



anus should be made in the groin. This preliminary measure is most advantageous when the operation is to be by the sacral method, and is by some advocated in all cases as preparatory for it. It is usual to make the anus in the left groin, but if the meso-sigmoid is short, and the amputation likely to be a high one, the first opening should be closed, and a colonic anus made in the right groin. By so doing there will be less difficulty in pulling down the requisite amount of bowel for fixation either in the sacral or perineal regions.

**Perineal proctectomy.**—The term perineal is not particularly apt, as the operation is not strictly through the perineum, which is situated mostly anterior to it. The term serves, however, to distinguish it from the other two regions from which the gut may be approached. The operation is sometimes spoken of as Lisfranc's, inasmuch as this surgeon was the first to place it upon a practical basis. This was in 1830.

The patient is placed in the lithotomy position. A sharp-pointed curved bistoury is introduced at the anus, guided by the index finger of the left hand. The point is made to transfix the bowel posteriorly opposite the apex of the coccyx; it is then made to cut its way outwards keeping strictly to the middle line. The lower part of the bowel is thus completely laid open. After securing any bleeding points, the edges of the wound are each transfixed by a piece of silk of sufficient length to admit of their being held firmly apart while the next stage of the operation is proceeded with.

The next step in the operation is to commence a separation of the lower end of the rectum. If the anus is to be preserved, then an incision is carried round the bowel at the junction of the mucous membrane and the skin; if not, then a circular incision is made through the skin just external to the anus, and the external sphincter therefore removed. After this incision the finger will best aid in detaching the bowel. In order to free it more readily, and also for manipulative purposes, the lowest part of the bowel should be secured by ring vulsellum forceps or preferably by a stout silk thread. Grasping either of these with the left hand, the operator can pull the rectum to one or the other side, backwards or forwards, and so very materially facilitate its detachment either by the fingers, blunt instruments, or the scissors, from the neighbour-

ing parts. Care must be taken when separating in front not to injure or open the vagina in the female, or similarly the urethra and the prostate in the male. The introduction of a catheter into the bladder will serve to indicate the position of the urethra.

When the upper limit of the diseased part is reached the bowel is severed. This may be effected either by the *écraseur*, the cautery, or the scissors. Hæmorrhage occurring during the operation should be checked by the application of forcipressure forceps, or small pressure pads.

There is little use in attempting to bring the mucous membrane above down to the skin and stitching it there, as the tension which necessarily exists invariably causes the sutures soon to cut through. The part should, therefore, be freely irrigated, dried, and dusted with iodoform. A large-sized rubber tube should be passed into the bowel, and the parts around packed with iodoform gauze. Opium should be freely administered, in order to bind the bowels for several days. Later, dilatation will have to be kept up by the continuous use of bougies.

Cripps<sup>1</sup> uses a full-sized bougie  $1\frac{5}{16}$  inch in diameter. It is employed at the end of a fortnight, and allowed to remain in some hours daily for a month. The patient is then directed to pass the bougie daily for a year or even longer. The tendency to contraction seems to gradually disappear and give comparatively little trouble after the second year.

Should the peritoneal cavity be opened, an attempt may be made to close it; failing this, however, no harm is likely to accrue if the wound proper has been rendered carefully aseptic.

In the course of a day or two, the stuffing should be removed, and fresh introduced. If, however, there has been any leakage of fæces, or the wound in any other way appears septic, the wound should not be restuffed, but irrigated with some antiseptic solution three times a day.

<sup>1</sup> *Brit. Med. Journ.* 1892, vol. ii. p. 1277.

## CHAPTER LXXXIII

OPERATIONS (*continued*). SACRAL PROCTECTOMY

**Sacral proctectomy.**—The object of this operation is to remove disease situated too high up to be dealt with by the perineal method.

The operation will be best considered by treating it in three stages. (1) The incisions made for exposing the bowel; (2) removal of the bowel; (3) the securing of the upper segment after amputation. An exception is made in the case of Kraske, whose first operation, described in full, was carried out successfully in 1885. It was the pioneer of the class, and although numerous modifications have been introduced since, the name of this surgeon is still retained and used to express amputation of the rectum from behind.

(1) *The incisions made for exposing the rectum.*—The operation, as carried out by Kraske<sup>1</sup> in his first two successful cases, was thus performed: The patient was laid upon the right side; an incision was made in the middle line down to the bone, from the centre of the sacrum to the anus. The skin and subcutaneous tissue with the fibres of the gluteus maximus were detached from the lower part of the left side of the sacrum. The coccyx was then removed. The lower part of the great sacrosciatic ligament, and the lesser ligament beneath it, were next detached from the side of the sacrum. With a gouge the lower part of the left side of the sacrum was removed, the cut being concave, starting from the margin of the bone on a level with the lower border of the third left sacral foramen, and including within the detached fragment the fourth sacral foramen (see fig. 117). After freeing the connective tissue and muscles from the posterior wall of the gut, the patient was placed in the lithotomy position, with the pelvis well raised. The connections anteriorly were then severed. As the disease in neither case involved the anal segment of the gut, the healthy bowel below was divided transversely after having been previously split up to within half an inch of the disease. The

<sup>1</sup> *Archiv für klin. Chir.* 1886, Bd. xxxiii. p. 563; also *Beilage zum Centralblatt für Chirurgie*, 1885, No. 24, p. 75.

rectum above the seat of disease was also cut across with a pair of scissors. The peritoneal cavity, which had been opened

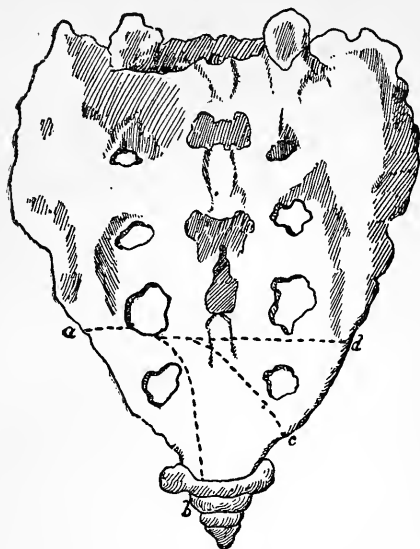

FIG. 117.—SHOWING THE AMOUNT OF BONE REMOVED BY DIFFERENT OPERATORS

*ab*, Kraske; *ac*, Hoehenegg; *ad*, Kraske for extreme cases. (Hoehenegg)

in the process of detaching the bowel, was then cleaned and dusted over with iodoform, and then the bowel above drawn down, and stitched for two-thirds of its circumference with the lower anal segment. A drainage tube was passed into the peritoneal cavity on the left side. The bowel was also tightly stuffed in order to press the peritoneal surfaces together. The wound was finally tamponed with iodoform gauze.

Notwithstanding the success which attended these two operations, surgeons soon began to learn

by experience that various improvements were needed if the best results were to be obtained. Hence numerous modifications were rapidly introduced, and concerned the mode of approach to the rectum, its removal, and the treatment of the parts after removal.

The particular points which these various modifications aimed at were: to retain a proper support to the bowel and the pelvic contents: to avoid any injury to the nerves supplying the bladder and the levator ani: to avoid interference with the blood supply of the lower part of the bowel: to lessen the hæmorrhage; and to obtain for the patient some control over the contents of the bowel.

The attempt to retain the normal osteo-ligamentous support to the floor of the pelvis led to the introduction of the formation of osteo-integumental flaps, that is to say, flaps composed of bone and the superimposed soft tissues, which,

after being temporarily turned aside for the excision of the diseased part, are replaced and secured in their original position.

Associated with this method of operating are the names of many German surgeons—Heineke, Kocher, Levy, Hegar, Rehn, Rydygier, Borelius and others.

Some of these methods may be shortly referred to.

*Heineke's method.*<sup>1</sup>—Heineke led the way in making the first modification of this nature in Kraske's operation. It was published in 1888, the year following the record of Kraske's original operation.

The incision was carried through the sphincter, along the middle line to the top of the coccyx, so that the lower part of the bowel was first opened and dealt with as further described. The incision was then continued along the median line of the sacrum, the bone sawn through in the same line as far up as the lower level of the third sacral foramina. Two cuts were then carried transversely outwards on each side, and the triangular osteo-integumental flaps thus made forcibly turned outwards, exposing freely thereby the posterior rectal region.

*Kocher's method*<sup>2</sup> resembles, in the shape and constituents of its flaps, that of Heineke. It differs, however, in the manner in which the flaps are cut. Kocher, after making his median posterior incision, detaches the soft parts laterally as far as the posterior sacral foramina. A thin strip of bone is then chiselled out so as to open the spinal canal and expose the sacral nerves. These—the third and fourth—are then carefully held aside while the sacrum is sawn across just below the third sacral foramina.

*Levy's method.*<sup>3</sup>—In this a horizontal and not a median skin incision is made. An incision skin and fascia deep is carried across the sacrum about a finger's breadth above the cornua of the coccyx. Its two lateral extremities pass outwards and downwards so as to slope in a direction parallel to the fibres of the gluteus maximus. Each terminates laterally about two inches from the tuber ischii. The fourth sacral foramen is identified. The fibres of the gluteus maximus are separated on each side until the sacro-sciatic ligaments

<sup>1</sup> *Centralblatt für Chirurgie*, 1888, No. 52, p. 962.

<sup>2</sup> McCosh, *New York Med. Journ.* 1892, vol. lvi. p. 256.

<sup>3</sup> *Berliner klin. Wochenschrift*, 1893, No. 13, p. 304.

are laid bare. These ligaments are then carefully divided upon a director (to avoid injuring the pudic vessels and nerve) in the line of the original incision until the lateral margin of the bone is reached. This division of the ligaments only, therefore, detaches a portion of them from the bone; that which is attached to the lower part of the sacrum and the coccyx remains intact. The parts in front of the sacrum are separated along the same horizontal line sufficiently to admit of the chain-saw being introduced. By this means the sacrum is sawn across. The broad osteo-integumental flap is then forcibly pulled backwards towards the anus, and the posterior rectal region exposed.

*Hegar's method.*<sup>1</sup>—In this operation the osteo-integumental flap is the opposite of that of Levy's, being turned up instead of down. Two divergent incisions are made from the anus to the side of the sacrum opposite the lower level of the third sacral foramina. The parts are separated laterally until the chain-saw can be introduced, and the bone cut through subcutaneously. The flap is then forcibly drawn upwards, and the posterior rectal region exposed.

*Rehn's method.*—In 1890 Rehn<sup>2</sup> described, at the nineteenth Congress of German Surgeons, cases successfully treated by a modification of Kraske's operation; and in 1894 Rydygier<sup>3</sup> followed with the description of an operation precisely similar. Of all the osteo-plastic methods at present devised, this appears to have superseded all others, and received most practical recognition. It is sometimes, and perhaps most appropriately, designated the *Rehn-Rydygier* method.

It is thus performed:—An incision is commenced close behind the posterior superior spine of the ilium, and continued along the left of the sacrum about half an inch from the margin of the bone; when it reaches the apex of the coccyx it is prolonged in the median line, as far as is considered necessary. At the upper end of the incision, the margin of the sacrum is then exposed, and the greater and lesser sacro-sciatic ligaments divided. The anterior part of the sacrum is

<sup>1</sup> Gerster, *Annals of Surgery*, 1895, vol. xxii. p. 489.

<sup>2</sup> *Beilage zum Centralblatt für Chirurgie*, 1890, No. 25, p. 65.

<sup>3</sup> Kelsey, *Annual of the Universal Medical Sciences*, 1894, vol. iii. E—11.

next carefully denuded of its soft parts; after which a transverse incision is carried across the sacrum from the original incision, at a point about two inches from the junction of the sacrum and the coccyx, that is to say, just below the third sacral foramina. The sacrum is chiselled through at the same level, and the large triangular flap thus made drawn over to the right side.

After removal of the disease the osteo-integumental flap is replaced, but whether or not it should be stitched into position will depend upon the amount of bowel which has been removed; whether, in other words, the bowel has been sutured to the anus or anal segment, and it is considered possible no leakage will take place, or whether no such union has been attempted between the divided extremities. In the former case it may be secured, in the latter it should not, but the cavity should be stuffed with iodoform gauze.

*Borelius' method.*<sup>1</sup>—The patient is placed upon the right side, with the knees drawn up and the pelvis raised. The skin incision is carried from the tip of the coccyx upwards to a little above the middle of the sacrum. Below, the skin incision follows the lower border of the right gluteus muscle. The right skin flap with some of the tendinous attachments of the gluteus are detached from the bone and held aside. The left skin edge is also sufficiently loosened to allow of the sacrum being chiselled through obliquely from below the third left sacral foramen to below the right fourth. This bone flap when sufficiently freed is drawn over to the left until after the operation upon the bowel is completed, when it is replaced.

These six methods of forming osteo-integumental flaps are not applicable when a sacral anus has to be made. Their great advantage lies in the support which is given to the bowel and the intrapelvic contents when it has been found possible to accurately unite the divided extremities of the former, or bring the upper segment of the gut down to the perineum without much traction.

Another method of maintaining good support to the bowel has been devised by Zuckerkandl and by Wölfler. It is spoken of as the '*parasacral method*,' and consists in dividing the

<sup>1</sup> McCosh, *New York Med. Journ.* 1892, vol. lvi. p. 257.

structures attached to the left side (Zuckerkanndl) or the right side (Wölfler) of the sacrum, that bone remaining intact. Wölfler in addition takes away the coccyx. Both surgeons claim to have operated with good results. The space which the incision allows is somewhat limited, hence removal of extensive diseases is apt to be difficult, if not impossible.

(2) *Removal of the rectum.*—By whatever method the bowel is approached or exposed, the next point for consideration is the removal of the diseased part.

The freeing of the gut from its connection should be either with the finger or with some blunt instrument, and where divisions are needed the scissors should be used. Bleeding points should be at once caught up with catch forceps, and all parenchymatous oozing checked by stuffing. If the peritoneal cavity is opened, it should be carefully protected while the bowel is removed. This latter may be effected either by the scissors, the cautery, or the *écraseur*. When it is impossible to tell by external examination the height to which the disease has extended, the bowel should be opened and the finger introduced to determine the proper point for making the division. To prevent the possibility of the upper segment slipping out of reach in cases of high amputation, care should be taken to properly secure it with forceps before severance is completed.

After the bowel has been excised the wound should be carefully cleansed, and then the opening in the peritoneal cavity sought for. Although but little harm has in many cases followed leaving the peritoneal opening untouched, the general opinion is that if closure is possible it should be effected.

The next step in the operation is to bring the gut down, and here I quote from the directions which are well expressed by Gerster<sup>1</sup>: 'Where high amputation is to be performed, the surgeon must try sedulously to preserve the nutrient vessels of the mesentery, otherwise the entire rectal stump may mortify. This will be found most difficult in that part of the rectum which adjoins the flexure. Lateral incisions through the peritoneal attachments are permissible, but cutting into the mesenteric line itself will certainly be followed by disaster. Adequate lateral incisions will permit the surgeon to peel up

<sup>1</sup> *Annals of Surgery*, 1895, vol. xxii. p. 494.



the gut from the sacrum by the gentle use of the finger-tip. The higher this detachment of the gut is carried up, the less tension will have to be encountered in drawing down and attaching the stump to the upper angle of the external incision, especially where portions of the sacrum have been removed. A few stout silk sutures passed through the entire thickness of the gut laterally will serve amply to anchor the gut to the skin, the rest of the wound remaining open.'

(3) *The securing of the upper segment after amputation.*—The ideal result is obtained when it is possible to retain normal control through the external sphincter. Retention of the external sphincter is of course only possible in cases where the anal portion of the gut is not implicated; and further its future use as a sphincter is only possible when the upper segment can be brought down without tension to be attached to the anal portion.

Where such union of the two divided segments seems feasible, it may be attempted by one of two methods—either by circular suture, or by some mechanical means, as by Murphy's button.

In most of the earlier cases of circular suture, some of the stitches gave way and fistulæ resulted. Kuster<sup>1</sup> observes that in every case in which he stitched the bowel completely round, the stitches cut out posteriorly and a fistula resulted. In some of these the systematic use of a rectal bougie caused the fistula to close, but in others its passage had no effect. Czerny<sup>2</sup> never obtained a good sphincter action after suture without splitting the sphincter first. Schede, Kammerer, and others do not attempt union by suture without making a preliminary inguinal anus.

The union of the divided ends by a Murphy's button has been successful. Marcy<sup>3</sup> reports having excised four inches of the rectum by a modified Kraske and united the ends by a large-sized button. The button, which caused some irritation of the bladder, was passed on the twelfth day; a fistulous opening, however, formed posteriorly at the site of union.

In order to get over the difficulty caused by the sutures

<sup>1</sup> *Berliner klin. Wochenschrift*, 1889, vol. xxvi. p. 193.

<sup>2</sup> *Beiträge zur klin. Chir.* 1892, Bd. ix. p. 409.

<sup>3</sup> *Boston Med. and Surg. Journ.* 1893, vol. cxxix. p. 561.

giving along the line of union of the two united segments, Hoehenegg<sup>1</sup> proposed to invaginate the stump into the lower segment of the gut, drawing it out through the anus and attaching it to the skin; and in order to ensure better union between the opposing surfaces, the epithelial lining of the anal ring within the sphincter was to be removed.

Another suggestion to overcome the difficulty in bringing the upper segment down to the normal position, when, by doing so, too much tension would be caused, has been made by Lange,<sup>2</sup> who successfully acted upon it in two cases. An incision was made from one tuber ischii across the perineum in front of the sphincter to the other. The incision was made deep enough to allow of pushing the whole muscular apparatus of the anus with the anal portion of the gut upwards. Thus fully two or three inches was gained, and exact union of the gut margins with suture achieved. Two years after the performance of this operation upon two men, both were reported in good condition. In both instances solid fæces could be held, and there was a decided sphincter action, not energetic enough, however, to restrain liquid fæces.

When for any reason it is not possible to make use of the normal sphincter, two methods of obtaining an adventitious sphincter action have been devised.

Willems<sup>3</sup> proposes for a sphincter an opening through the gluteus maximus. A skin incision about two to two and a half inches long is carried obliquely downwards and outwards above the tuber ischii. The incision runs parallel to the fibres of the gluteus maximus, the fibres of which are then separated by the forceps to the breadth of the finger. Through this opening the stump of the bowel is pulled and stitched to the skin. When the amputation is higher up it is proposed to make the opening through the gluteus correspondingly higher.

In the following year Witzel<sup>4</sup> described a similar method of obtaining a sphincter, and designated the artificial anus 'rectostomia glutealis.' A little later Rydygier<sup>5</sup> appears to

<sup>1</sup> Gerster, *Annals of Surgery*, 1895, vol. xxii. p. 495.

<sup>2</sup> *New York Med. Journ.* 1891, vol. liii. p. 309.

<sup>3</sup> *Centralblatt für Chirurgie*, 1893, vol. xx. p. 401.

<sup>4</sup> *Ibid.* 1894, No. 40, p. 938.

<sup>5</sup> *Ibid.* No. 45, p. 1033.

have hit upon the same plan, which is illustrated by a drawing.

Gersuny<sup>1</sup> records two successful results by an ingenious method of torsion. After removal of the diseased portion, the upper segment is pulled down, and by two pairs of forceps placed on opposite sides the bowel is twisted until the finger feels some resistance when introduced and pushed up. It is then stitched to the skin margin. In both the cases so treated there was power to retain fæces.

If no attempt is to be made to obtain any sphincter action, then the bowel must be either left in position with the introduction of a tube from the lowest part of the wound into it, or it must be secured to the skin of the wound at such a point as allows of little or no tension; in other words, a sacral anus must be formed. In either of these methods the wound cavity must be loosely stuffed with iodoform gauze and left freely open.

**After treatment.**—Every effort must be made to keep the bowels confined for a few days, by the administration of opium, and a milk diet. When the metal button is used, it is advised by Murphy that an early and free use of laxatives be employed, so that the button may not become dammed up with solid fæces.

When a wound has been stuffed, the tissue should be removed after forty-eight hours, and earlier if there is any fear of fecal leakage, or any symptoms of sepsis. It may be restuffed, or freely and frequently irrigated, according to circumstances.

When once the wound is freely granulating, and there is no indication of inflammation, the patient may be allowed to rise, and sit or even walk. The earlier this freedom can be permitted, the better.

In cases of sacral anus, Hochenegg has devised a pad which is secured by a hinge to a belly band. It is kept firmly applied to the orifice by a strap passing from the front down between the legs, across the perineum and up behind. According to Thorndike,<sup>2</sup> who figures the apparatus, it does its work efficiently and with comfort to the patients.

**Vaginal proctectomy.**—Little has been done with regard to

<sup>1</sup> *Centralblatt für Chirurgie*, 1893, vol. xx. p. 553.

<sup>2</sup> *Boston Med. and Surg. Journ.* 1891, vol. cxxiv. p. 456.

approaching the rectum through the vagina. In 1895 Rehn described an operation which he had performed on an old woman aged 81 years; but in a footnote appended to the description Richter points out that Campenon had already successfully performed the operation.

The mode of operating is thus briefly described by Rehn.<sup>1</sup> The rectum is tamponed, and the vagina thoroughly disinfected. A shallow median incision is carefully made in the posterior wall of the vagina, reaching to the sphincter ani. The rectum is separated first at the anal extremity, and then pulled up by an assistant towards the symphysis, by which means the requisite length of the gut is detached.

It remains to refer briefly to three other methods of dealing with disease situated high up in the rectum, or of a character too fixed to remove.

(1) *Removal by Maunsell's method* (see page 532).—The abdomen is opened, an incision made in the sigmoid, and the diseased segment invaginated into the latter, brought out of the intestinal orifice and removed, union of the gut ends being then effected as in the same operation for intussusception. The operation was successfully carried out in a case reported by Hartley.<sup>2</sup>

(2) Uhlmann<sup>3</sup> proposes to expose the rectum by an ordinary Kraske, bring down a piece of intestine and suture it into the rectum below the seat of disease. The proposed operation is termed 'Colo-rectostomy.'

(3) Bacon<sup>4</sup> suggests opening the abdomen and stitching a coil of intestine to the rectum. When adhesions have sufficiently formed, an opening is made into the bowel from the rectum, below the disease in the latter. The method is well described by illustrations.

**6. Proctorrhaphy.**—The term is used to indicate suturing the ends of the rectum together after excision. If, however, an endeavour is to be made to acquire some uniformity in the terminology of operations upon the alimentary canal, the name should strictly apply to Lange's operation for prolapse

<sup>1</sup> *Centralblatt für Chirurgie*, 1895, No. 10, p. 243.

<sup>2</sup> *New York Med. Journ.* 1892, vol. lvi. p. 464.

<sup>3</sup> *Annual of the Universal Medical Sciences*, 1890, vol. iii. D—35.

<sup>4</sup> *Ibid.* 1895, vol. iii. D—11.

of the rectum (see page 652). The prolapsed and enlarged bowel is narrowed in its calibre, by inserting two rows of buried sutures, which have the effect of doubling in a longitudinal fold.

7. **Proctopexy.**—An operation performed for fixing the rectum in cases of prolapse. (See Verneuil's operation, page 649.)

8. **Proctoplasty.**—The term is applied to the various operations employed to open up and transplant into the perineum the rectum in cases of imperforate anus (see page 665). In view of the specific application of the affix in the case of the stomach and the intestine, it would be wiser to abolish the use of the term here.

9. **Rectal Electrolysis.**—Used for the treatment of stricture of the rectum. (See page 599.)

10. **Rectal Cauterisation.**—Used for the treatment of prolapse. (See Van Buren's operation, page 643.)

---

## CHAPTER LXXXIV

### RECTAL ADMINISTRATIONS

**Nutritive and therapeutic enemata.**—The importance of utilising the absorptive powers of the mucous membrane of the rectum, in the surgery of the alimentary canal, is so great, that a separate though brief reference to the subject seems a fitting conclusion to the present work.

It may be considered in two aspects, that of alimentation, and that of medication.

**Alimentation.**—The administration of food by the rectum is of importance in all cases where its introduction into the stomach is impossible, or fraught with risks of injury to parts which have been operated upon.

Prior to giving the enema, an ordinary copious injection of warm water should be employed, in order to empty the part and cleanse it (see page 677). The patient should lie either on the back or the side, and remain in the recumbent position for some time after the administration.

For introducing the aliment, either a syringe or a filler or funnel attached to an india-rubber tube may be used. A rectal tube of at least six inches in length should be connected with the india-rubber tube or the nozzle of the syringe, and introduced as far up the bowel as possible. This high introduction of the food is of considerable importance, as bringing it into relation with a larger absorptive surface, and also rendering it possible for the material to find its way into the colon.

No sudden or great force should be used in injecting the aliment. If a filler and tube is used, the former should be held about two feet above the bed, and the material allowed to gravitate slowly into the bowel.

The quantity administered should be from two to six ounces, and warmed to about the temperature of the body. From two to four enemata may be given daily, the number varying with the quantity and the quality of the nutrient used; and if the bowel does not empty itself naturally within forty-eight hours, a copious water injection should be given before repeating the enema. It has been shown that the ingredients most readily absorbed are such as can be held in solution; hence albumen as such is not taken up, and must be peptonised.

The following are good formulæ for rectal alimentation taken from Eugene Forster's article in the 'Reference Handbook of the Medical Sciences.'<sup>1</sup>

*Leube's pancreatic meat emulsion.*—'Take about five ounces of finely scraped meat, chop it still finer, and add to it one ounce and a half of finely chopped pancreas free from fat, then add about three ounces of lukewarm water, and stir to the consistence of a thick pulp.' This constitutes the quantity for a single injection.

*Mayet's preparation.*—'Take of fresh pancreas of the ox from 150 to 200 grammes, and of lean meat 400 to 500 grammes. Bruise the pancreas in a mortar with tepid water at a temperature of 37° C., and strain through a cloth. Chop the meat and mix it thoroughly with the fluid which has thus been strained, after separating all the fat and tendinous portions. Add the yolk of one egg. Let stand for two

<sup>1</sup> Vol. ii. p. 693.

hours, and administer at the same temperature.' The quantity made is supposed to be sufficient for twenty-four hours' nourishment, and should be administered in two doses.

*Rennie's formula.*—'To a bowl of good beef tea add half a pound of lean raw beef steak pulled into shreds. At 99° F. add one drachm of fresh pepsin and half a drachm of dilute hydrochloric acid. Place the mixture before the fire and let it remain for four hours, stirring frequently. The heat must not be too great, or the artificial digestive process will be stopped altogether.'

The use of blood as a nutrient enema is highly recommended by Sansom,<sup>1</sup> who thus described its preparation and administration :

'Ox blood is usually employed, but sheep's blood may be used. It is necessary that it be defibrinated the moment it is drawn. Butchers understand this process, and will supply what is called "whipped" or "stirred" blood. It is, of course, required that the blood be fresh, that it be not kept more than a single day (a grain or a grain and a half of chloral hydrate to each ounce of blood serves to avert decomposition and prevent any offensive odour in the dejection). In urgent cases where there is no stomach digestion two or three ounces of blood may be injected into the rectum every two or three hours; the fluid may be warmed by placing the containing vessel in hot water, but it is often borne equally well when cold.'

In recent years much has been done to simplify the process of preparing food, but there are those who still prefer to use the entirely fresh and recently prepared ingredients rather than any of the condensed and more or less artificial preparations now abundantly to be obtained in the market. Many of the latter, however, have been shown experimentally to be capable of sustaining life for comparatively prolonged periods and fulfilling therefore all the requirements of rectal alimentation.

Some of these ready-made preparations are practically foods in themselves, while others are intended to be added

<sup>1</sup> *Lancet*, 1891, vol. i. p. 322.

to certain quantities of aliment for the purpose of digesting them.

The following are some of the preparations met with in commerce. As full instructions accompany each substance, there is no need to introduce any particulars here.

Pepsin (B.P.) ; Pig's Pepsin ; Saccharated Pepsin ; Armour's Lactated Pepsin ; Pure Pancreatin ; Liquor Pancreaticus (Benger) ; Beef Peptonoids (Carnrick and Co.) in powders ; Liquid Peptonoids ; Zymine Peptonising Powders (Fairchild) ; Zyminised (Peptonised) Suppositories (milk) ; Zyminised (Peptonised) Suppositories (beef).

Forster speaks highly of the following simple nutrient enema :

Carnrick's Beef Peptonoids one to four drachms, milk, beef tea or rice water, four to six ounces given twice daily.

In the use of enemata it is advisable not to continue too long with one particular kind, but rather to employ every now and again one containing different ingredients. If the rectum becomes intolerant or irritable, a few drops of tinctura opii should be added to the enema. When stimulants appear needed, half an ounce or so of brandy may be mixed in. Ewald prefers adding red wine to each enema.

The absorptive power of the rectum for fluids has led to its being made use of as a means of getting water into the system when its administration in large quantities by the mouth might derange the stomach. Thus the injection of considerable quantities of warm water has proved to be of great service in cases where much blood has been lost, and in which shock is a prominent symptom. As thus given it is supposed to act in the same way as when normal saline solution is used for intravenous injection. In cases of excessive thirst from fever, and after certain abdominal operations, warm water given *per rectum* has often a very beneficial effect in allaying this troublesome and trying symptom.

**Therapeutics.**—Drugs are introduced into the rectum for the purpose of producing either local or general effects. In form they are either fluid or solid, in the latter case they constitute the suppositoria.

It is usual to classify enemata according to their action ;



thus there are purgative, anthelmintic, astringent, and sedative. Others are used by the physician, but these comprise those mostly in use in surgery.

*Purgative enemata.*—The mechanical effect of large quantities of fluid in inducing peristaltic action of the bowel has already been referred to (see page 677). It is possible, however, to bring about the desired effect by using a less quantity of water and adding to it some purgative drug. Thus castor oil or turpentine, an ounce of each, may be added to and well shaken up with six to ten ounces of thin gruel; or a solution can be made containing sulphate of magnesia. An enema of aloes consists of aloes two scruples, carbonate of potash fifteen grains, and barley water half a pint; or one containing colocynth consists of extract of colocynth half a drachm, soft soap one ounce, and water a pint; mix and rub together.

Glycerine is now much used, and is sometimes very powerful in its action, as was once observed by myself in the case of a patient who had been operated upon for hæmorrhoids some days previously. It caused much straining and very copious hæmorrhage. From one to two drachms are injected by a suitable syringe, and usually in from five to thirty minutes action of the bowels will follow. Glycerine suppositories are now made containing in some of the forms 95 per cent. of glycerine. Their action is stated to be attended with less spasm than when pure glycerine is injected.

*Anthelmintic enemata.*—Thread worms and round worms are both met with in the rectum, the former more frequently. Their presence in children is not unfrequently the cause of prolapse. Strong solutions of salt and water, or of quassia and water, will sometimes prove sufficient. Or an enema composed of one to four drachms of spirit of turpentine mixed with the yolk of an egg, and added to four to eight ounces of water, may be given repeatedly until the worms are destroyed. Two drachms of asafœtida or aloes in water also answer equally well.

*Astringent enemata.*—Solutions of many of the well-known astringents, both vegetable and mineral, may be used for rectal injection. Among the former is gallic acid, two grains of which should be mixed with each ounce of water. The mineral astringents comprise alum, sulphates of copper and

zinc, salts of iron, acetate of lead, and nitrate of silver. Most of these may be used in strengths varying from one to three grains of the salt to the ounce of water. Suppositories of hamamelin or injections of hazeline are also much in use.

*Sedative enemata.*—Enemata of this description are more frequently given for the production of a general than a local effect. And inasmuch as the result is practically the same whether the drug be given by the mouth or the rectum, all substances in the pharmacopœia which are described as sedative in their effect upon the nervous system can be introduced—provided the form is suitable—as well by the rectum as by the mouth. Much discussion has arisen regarding the relative quantities which should be given *per rectum*, as compared with what is usually administered by the mouth. Eugene Forster holds that from his experience the effect produced by a certain quantity given by the mouth is the same as that which results from the same quantity given *per rectum*. Others maintain that proportionately more should be given by the bowel; while there are those who contend that the quantity should be proportionately less. The simplest plan would therefore seem to be, and certainly the safest, to prescribe for an enema the same dose as that given for administration by the mouth. Among narcotics and sedatives which may be used as enemata are opium, morphia, belladonna, stramonium, cannabis indica, asafetida, conium, lobelia, gelseminum, musk, chloral, bromides of potassium and sodium.

# INDEX OF NAMES

---

- ABBE, 101, 256, 257, 345, 347, 348, 380,  
477, 531, 535, 537, 542, 543  
Abel, 661  
Acker, 583  
Adams, Jas. A., 220  
Adams, T. Rutherford, 607  
Adams, Wm., 12  
Adenot, 486  
Albert, 244, 524  
Allchin, 279, 280, 436  
Allen, 356  
Allingham, H. W., 553  
Allingham, Wm., 222, 397, 401, 476,  
544, 552, 586, 590, 591, 601, 604, 611-  
3, 615, 631, 632, 641, 643, 673,  
679  
Allis, 513  
Almqvist, 229  
Aly, 418  
Amussat, 544  
Anders, Ernst, 655, 662, 663, 668  
Anderson, H. A. C., 293  
Anderson, Wm., 484  
Andrew, Grant, 158, 337, 634  
Angerer, 221  
Annandale, 33, 55, 57, 58  
Arnot, 615  
Ashby, 390  
Atlee, 304  
Audry, 89
- BACON, 692  
Ball, Chas. B., 597, 603, 606, 612, 615,  
637, 641, 661, 663, 670, 671  
Ball, Wm. T., 36  
Ballance, 543  
Ballinger, 172, 173  
Ballot, 132  
Baltzer, 416  
Banks, 386  
Baracz, 255, 549  
Bardamant, 172  
Bardleben, 222  
Barker, A. E., 250, 252, 258, 386, 387,  
515, 535, 559  
Barker, E. J., 608  
Barling, 501  
Barr, 342  
Barrs, A. G., 351  
Bartolomé, 441  
Barton, 222  
Battle, 306, 310, 558  
Baur, 377  
Beaumez, 631  
Beaumont, 148  
Beck, 162, 167, 170  
Bell, 646  
Benham, 452  
Bennet, Risdon, 444  
Bennet, W. H., 186, 188  
Berg, 172, 643, 652  
Bergmann, von, 123, 124, 141, 142  
Berkham, 123  
Bernays, 171, 215, 268  
Bernheim, 294  
Berry, Jas., 75, 96, 456, 457  
Best, 172  
Bickersteth, 606  
Bier, 535  
Biggs, 280  
Billard, 40, 41, 42  
Bilroth, 80, 93, 180, 206, 207, 221, 251,  
252, 255, 263, 264, 434  
Bircher, 224, 225, 247  
Bird, Golding, 239, 436  
Birmingham, 485  
Bishop, 526, 529, 530  
Blume, C. A., 3, 49, 50  
Boas, 292  
Bodenhamer, 655, 661  
Bogdanik, 646  
Boiffin, 362  
Boisvert, 126  
Bond, 210  
Bonuzzi, 450  
Borelius, 685, 687  
Borri, 560  
Bowlby, 603, 604, 609, 636  
Boyd, Francis D., 485  
Boyd, Stanley, 13, 65  
Bradford, 174, 175, 18

- Braham, J. H., 364  
 Braillet, 301, 302  
 Brandt, 248  
 Branson, 342  
 Briddon, 390, 392, 476  
 Bridgeman, 26  
 Brinton, 107, 108, 148  
 Bristowe, 62, 113, 131, 344  
 Broca, 363  
 Brokaw, 256, 542  
 Brown, Lennox, 25  
 Browne, H. L., 92  
 Bruce, 41  
 Brush, 40  
 Bryant J. D., 490, 491  
 Bryant, Thomas, 236, 447, 449, 452,  
     525, 544, 566, 596, 601, 604, 612,  
     624, 641  
 Buchwald, 411  
 Bucquay, 278, 280, 281  
 Buist, 158  
 Bull, 222, 321, 323, 327, 447  
 Buren, van, 604, 643, 672, 674, 693  
 Burghard, 593  
 Burnet, 61, 66  
 Butcher, H., 363  
 Butlin, 16, 59, 62, 65, 117, 124, 111  
 Buzzi, 422  
 Byron, 661
- CABOT, 18  
 Cadge, 568  
 Cahill, 132  
 Cahn, 290  
 Callender, 390  
 Callisen, 544  
 Cameron, Hector, 351, 494, 514  
 Campbell, 137  
 Campenon, 692  
 Cant, W. T., 168, 171  
 Carmalt, 323, 327, 328  
 Carpenter, 148  
 Carver, 378, 389  
 Cave, E. J., 362, 363, 369, 370  
 Chaffey, 19  
 Championnière, Lucas, 368, 370,  
     418  
 Chapman, 82  
 Chaput, 555  
 Chavasse, 122, 123, 125  
 Cheadle, 383, 384, 481  
 Cheatham, 56  
 Cheyne, Watson, 371  
 Chiari, 413  
 Christie, 321  
 Church, 21  
 Churton, 132, 498  
 Clark, Sir Andrew, 32  
 Clark, Henry E., 402
- Clarke, Bruce, 384, 386, 403  
 Clarke, J. J., 668  
 Clarke, Jackson, 350, 351  
 Clarke, T. Kilner, 253  
 Clayton, 157, 158  
 Cleghorn, 222  
 Clutton, 103, 407, 463  
 Coates, 362  
 Coats, Joseph, 47, 48, 56, 57, 201, 280,  
     352, 354, 517  
 Cohen, Solis, 8, 13, 29, 31, 34, 36, 113,  
     116, 126, 135, 141, 143, 155, 170,  
     295, 447  
 Collier, J., 274  
 Collier, Mayo, 107  
 Collier, William, 228  
 Conant, 664, 668  
 Condie, 41  
 Conley, 306, 307  
 Cook, 604  
 Cooper, 589, 591, 604, 637, 661  
 Cooper, Astley, 351  
 Cordier, A. H., 364  
 Cotterell, Edward, 240, 385  
 Coupland, 434, 607  
 Courteen, 470  
 Courtenay, 28  
 Courvoisier, 255  
 Cousins, T. Ward, 461  
 Coutaret, 159  
 Crary, 126, 128  
 Credé, 598  
 Créquy, 34  
 Cripps, Harrison, 240, 369, 370, 391,  
     460, 549, 551-3, 562, 564, 565, 589,  
     604, 606, 613, 622, 625, 653-5, 660-  
     668, 674, 682  
 Croft, 75, 306, 310, 311, 658  
 Cropf, 417  
 Cruveilhier, 658  
 Cunningham, 119  
 Curling, 277, 284, 286, 287, 655, 663  
 Curnow, 434  
 Curtis, 430  
 Czerny, 80, 221, 260, 434, 528, 529,  
     625, 626, 628, 629, 689
- DALTON, 462, 467  
 Dalziel, T. K., 185, 188  
 Daniel, 503  
 Danzel, 608  
 Davy, 113, 114, 116, 130, 568  
 Dawbarn, 255, 538  
 Dean, 282, 283, 296, 363  
 Debove, 48, 87, 91  
 Dechambre, 100  
 Dehio, 155  
 Demoulin, 515  
 Dent, 363

- Desmos, 63  
 Dewhurst, 181  
 Dexter, 422, 483  
 Dickinson, Lee, 193, 194, 196  
 Dickson, 170  
 Dieulafoy, 22J  
 Dionisi, 46  
 Dixon, 96  
 Dodd, 30, 485  
 Dörfler, 363, 365, 390, 392  
 Doyle, H. Martin, 26  
 Doyle, J. P., 442  
 Draper, 517  
 Ducheneau, 205  
 Duffin, 34  
 Dunlap, 338  
 Dunn, L. A., 186, 189, 606  
 Dupuytren, 555  
 Duret, 225, 248  
 Durham, A., 75  
 Dyson, 468
- EARLE, 567, 599  
 Eberth, 51  
 Ebstein, 206  
 Eccles, 379, 384  
 Eddison, 51  
 Edmunds, 543  
 Edwards, 589, 591, 604, 637  
 Egebert, 232, 242, 244  
 Einhorn, 112-114, 117, 150, 156  
 Eiselsberg, 264  
 Eisendrath, 505  
 Eklund, 101  
 Eloy, 107, 111  
 Emerson, 293, 294  
 Emmet, 654  
 Erichsen, 157, 273  
 Esson, 306  
 Eve, 22, 95, 100, 281, 283, 337, 386,  
 404, 406, 408  
 Ewald, 149, 150, 153, 155, 180, 208,  
 209, 696
- FAGGE, HILTON, 55-7, 123, 129, 182,  
 207, 397, 636  
 Fairweather, 497  
 Fehleisen, 208  
 Fenger, 232, 233  
 Fenwick, Hurry, 573, 676  
 Fenwick, W. Soltau, 228, 229  
 Féré, 118  
 Ferguson, 222  
 Ferrier, 601  
 Finlayson, Jas., 47, 66, 67, 71, 468  
 Finney, 36, 452  
 Finny, 61  
 Fitz, 10, 11, 492, 507
- Fleming, R. A., 154  
 Fleming, W. J., 415, 416  
 Flexner, 53  
 Floyer, 464  
 Formad, 478  
 Forster, Eugene, 694, 696, 698  
 Fort, 72, 98  
 Foulerton, 463  
 Fowler, G. Ryerson, 351, 369, 482, 492,  
 496-8, 500, 504, 507, 508, 512, 568,  
 649  
 Fox, Wilson, 281  
 Foxwell, 288  
 Foy, 230  
 Francis, 117, 119  
 Frank, R., 232, 244  
 Franklin, 361, 363  
 Franks, Kendal, 89, 94, 97, 98, 101,  
 464, 465, 474, 525  
 Fräntzel, 205  
 Frecman, 274, 276  
 Friedrich, 50  
 Fry, H. A., 42  
 Fuller, 661  
 Fütterer, 484
- GAIRDNER, JOHN, 302  
 Gairdner, W. T., 21, 28J  
 Gant, 70  
 Garré, 395, 400  
 Gaucher, 71  
 Gautier, 33  
 Gérard, 241  
 Gerster, 320, 321, 686, 688, 690  
 Gersuny, 75, 77, 78, 691  
 Gibbs, John Blair, 577, 585, 586  
 Gilford, H., 185, 188  
 Glénard, 227, 248  
 Glover, 29  
 Godlee, R., 12, 386, 579  
 Godwin, 613  
 Goerne, 577  
 Goodhart, 16, 436  
 Goodsall, 571, 604  
 Gordon, 198  
 Goselin, 604  
 Goubaux, 168  
 Gould, 452  
 Gowlland, 604, 612  
 Gradenwitz, 114, 116  
 Grandon, 126  
 Grant, 542  
 Griffith, 306  
 Gross, Chas., 6  
 Gross, Sam. D., 661  
 Guinard, 220, 221  
 Gull, 172  
 Günzburg, 151  
 Gussenbauer, 434

- HABERSHON, 106  
 Hacker, von, 23, 134, 142, 232, 240-2,  
 255  
 Hadden, 61, 206, 433, 454  
 Hadra, 242  
 Hahn, 220, 223, 227, 232, 241, 244  
 Hall, 183  
 Halsted, 535, 543  
 Hamilton, 483  
 Handford, 112, 206, 462, 603  
 Hannay, 113, 116  
 Hardie, Jas., 27  
 Harrison, C. E., 11  
 Harrison, R., 335  
 Harte, 501  
 Hartley, 206, 207, 692  
 Harvey, 92  
 Hashimoto, 167  
 Haward, W., 187, 189, 364, 480  
 Hawkins, 342, 343, 390  
 Hayden, 133  
 Heath, 13  
 Heaton, 636  
 Hebb, 277, 280  
 Heelis, 274  
 Hegar, 685, 686  
 Heigl, 256  
 Heineke, 100, 215, 222, 265, 266, 292,  
 401, 443, 543, 685  
 Henschell, 72  
 Herzel, 600  
 Hering, 156  
 Herringham, 479  
 Heuck, 612, 614, 629  
 Heuston, 467  
 Hildebrand, 612, 630  
 Hilton, 182  
 Hirschsprung, 473  
 Hobson, 293  
 Hoehenegg, 684, 690, 691  
 Hochhaus, 292  
 Hoden, 60  
 Hoffman, 120  
 Hofmohl, 434, 463, 477  
 Hogner, 229  
 Holmes, T., 127, 186, 267, 286, 676  
 Holst, 607  
 Holt, 483  
 Hood, 306  
 Hook, van, 345, 347  
 Howse, 232, 234, 235, 238, 241  
 Huber, 125  
 Hudson, 420, 422, 423  
 Hughes, 182  
 Hulke, 670  
 Hunter, 285  
 Hurd, 484  
 Hutchinson, Jonathan, 37, 274, 275,  
 363, 383, 390, 404, 451  
 Hyrtl, 119
- INGALS, 89  
 Inman, 172  
 Irving, 362
- JACOBÆUS, MATHIAS, 43  
 Jacobson, 241, 263  
 Jacques, 240  
 James, David, 56, 57  
 Jeannel, 655  
 Jenkins, 572  
 Jessett, 208, 217, 221-3, 236, 249, 256,  
 523, 535, 540  
 Jessop, 498  
 Joal, 46, 51, 107  
 Jobert, 528  
 Johnson, 467, 471  
 Jonchères, 467  
 Jones, J. Harris, 607  
 Jones, Robert, 363, 366  
 Jones, Sydney, 232, 674  
 Jones, Thomas, 369, 370  
 Jounesco, 351  
 Jowers, R. F., 185, 188
- KAMMERER, 646, 689  
 Kappeler, 80  
 Kast, 289  
 Kauffmann, 418  
 Keen, 260  
 Kelsey, Chas. B., 551, 555, 580, 592,  
 601, 612, 648, 658, 661, 670, 671,  
 675, 680, 686  
 Kelynack, 277, 517  
 Kempe, 87  
 Kennicutt, 222  
 Khaloff, 454  
 Kleberg, 642, 648  
 Klebs, 113  
 Kleef, 180  
 Klein, Gustav, 63  
 Kidd, 459, 463  
 Knaggs, 384  
 Knott, 114, 131  
 Knox, D. N., 439  
 Koch, 363  
 Kocher, 124, 141, 142, 220, 252, 255,  
 685  
 Koehler, 104  
 König, 124, 394  
 Kooyker, 172  
 Körte, 386, 408, 434, 453  
 Kraske, 634, 683, 686, 689, 692  
 Krauss, 277  
 Kriege, 185, 188  
 Krishaber, 75, 79  
 Krogius, 199  
 Krönlein, 35  
 Kunze, 201  
 Kussmaul, 228, 486  
 Küster, 181, 689

- LACOMBE, 67, 109  
 Lane, W. A., 408, 409, 503, 515, 526  
 Lange, 99, 180, 222, 293, 296, 385,  
 589, 636, 643, 652, 690, 692  
 Langenbuch, 172, 205, 223, 246, 295, 296  
 Langenhaus, 44  
 Langhaus, 413  
 Larkin, 260  
 Latham, 119  
 Lauenstein, 221, 227, 260, 389, 552  
 Leichtenstern, 113, 119, 355, 361, 410,  
 517  
 Leiter, 24, 155, 567  
 Lembert, 529  
 Letuille, 51  
 Leube, 611  
 Leven, 126, 127  
 Levy, 203, 635, 686  
 Lewis, 637  
 Leyden, 193, 344  
 Lilienthal, 475  
 Limont, 159, 160, 222  
 Lindermann, 386  
 Link, 463  
 Lisfranc, 681  
 Littlewood, 256, 369, 537  
 Lockwood, 283, 375, 386, 481, 482, 484,  
 509  
 Logan, 638, 641  
 Loreta, 97, 215, 222, 267  
 Louis, 344, 345  
 Lövinsohn, 614, 626, 629  
 Lowe, 572, 574, 654  
 Lowson, 167, 222  
 Lubarsch, 413  
 Lubinski, 87, 88  
 Lücke, 221, 344, 347  
 Lundie, R. A., 186, 183  
 Luschka, 113  
  
 MAAS, 671  
 McAlister, 391, 392  
 McArdle, 452  
 McBurney, 385, 492, 500, 503, 515, 557,  
 558  
 McCall, 342  
 McCarthy, 487  
 MacCormac, 96  
 McCosh, 606, 610, 685, 687  
 MacEwen, Wm., 385  
 McGill, 556  
 McGraw, 257, 260, 322  
 McIlraith, 17  
 MacIntyre, John, 18, 24  
 Mackenzie, Hunter, 68  
 Mackenzie, H. W. G., 278  
 Mackenzie, Morrell, Sir, 2, 3, 17, 23,  
 24, 34, 38-41, 45, 46, 49-51, 51, 53,  
 57, 59, 68, 75, 80, 86, 99, 111, 115,  
 125, 132  
  
 Maclaren, R., 186  
 MacLennan, Alex., 445, 635  
 McLeod, K., 642, 651  
 McNutt, 447  
 McWeeny, 438  
 McWhinnie, 228  
 Macan, 607  
 Machel, 126  
 Madelung, 415, 416  
 Magill, 221, 258  
 Makins, 377, 379, 526  
 Mandach, 124  
 Marcus, 619  
 Marcy, 639  
 Marsh, F., 619  
 Marsh, Howard, 128, 360, 363, 377,  
 385, 609  
 Marshall, George, 402  
 Marshall, John, 276  
 Marten, 228  
 Martius, De Souza, 342  
 Masimoff, 640  
 Mathieu, 203  
 Matthews, 561, 566, 584, 539, 604,  
 631, 673  
 Maunsell, 532, 543, 692  
 Maurer, 180  
 Maurice, W. J., 183, 189  
 May, 172, 205  
 Maydl, 524, 551, 553  
 Mayet, 694  
 Mayo, W. J., 101, 256, 451, 452, 612  
 Mazotti, 53  
 Mears, J. Ewing, 345, 347, 454  
 Mekins, 126  
 Melsome, 483  
 Mentin, 453  
 Mercer, 410  
 Mercier, 660  
 Mermod, 116  
 Meyer, W., 99, 101, 242, 243, 244,  
 386, 418  
 Middledorf, 160  
 Middleton, George, 456, 458  
 Mikulicz, 24, 155, 180, 184, 215, 244,  
 265, 266, 292, 401, 443, 543, 612  
 Miles, 323  
 Minor, 158  
 Minowski, 209  
 Mintz, 121, 123  
 Mixter, 124  
 Monakow, 126, 130  
 Mondière, 104  
 Money, 468, 479  
 Monprofit, 362  
 Monro, T. K., 404, 446  
 Montaut, 104  
 Moore, N., 62, 121, 278, 279, 230, 289,  
 434, 469  
 Moorhead, J., 112

- Morejon, 85  
 Morgan, 658  
 Morison, 542  
 Morley, 14  
 Morris, H., 158, 187, 189, 508  
 Morrison, Rutherford, 82  
 Morse, J. H., 185  
 Morton, Charles A., 413, 414, 473  
 Morton, Thomas G., 287  
 Moullin, Mansell, 553, 663  
 Mouton, 3  
 Moxon, 43, 47, 61, 87, 432, 450  
 Moyes, John, 486  
 Moynihan, 508  
 Munro, 489  
 Murchison, 403, 404  
 Murphy, 221, 256, 260, 263, 264, 364,  
 365, 370, 541, 547, 689, 691  
 Murray, F. W., 101  
 Murray, H. M., 201, 281  
 Myers, 231  
 Mygind, 336, 401  
 Myles, 409
- NAPIER, Alexander, 506  
 Nassiloff, 80, 143  
 Nélaton, 522  
 Nepveu, 637  
 Newman, David, 62, 81  
 Newman, R., 60, 65, 599  
 Nicaise, 568  
 Nichols, 331, 332  
 Nicholson, R. H. B., 186  
 Nicclaysen, 363  
 Nordman, 568  
 Norman, 201  
 Nothnagel, 375
- OBALINSKI, 550  
 Obre, 676  
 Ochener, 386  
 Ochsner, 452  
 O'Connor, 378, 379  
 Oderfeld, 356, 361, 363  
 Oestreich, 478  
 Ogston, 4  
 Oliver, 432  
 Ord, 178  
 Ormerod, 436  
 Osgood, 109  
 Osler, 478  
 Owles, 72
- PAGE, F., 60, 71, 159, 160, 222, 303,  
 304, 660  
 Paget, G. E., 65  
 Paget, Sir James, 107  
 Paget, Stephen, 663, 664, 667, 670  
 Painter, 98, 137
- Pariser, 156  
 Parker, Chas. A., 432  
 Parker, C. T., 189, 227, 312  
 Parker, Rushton, 352, 363  
 Parker, R. W., 384  
 Parmentier, 62  
 Parsons, A. R., 181, 187, 189, 192, 200,  
 282  
 Pasteur, W., 191  
 Paterson, John, 634  
 Paul, F., 187, 189, 257, 369, 370, 473,  
 475, 538, 539, 547  
 Péan, 401, 443, 543  
 Pennington, 390  
 Penzold, 151  
 Perlick, 210  
 Pernice, 210  
 Perry, 206, 207, 209, 357, 416  
 Pick, Pickering, 195, 364, 386  
 Pietkiewicz, 43  
 Pisko, 170  
 Pitt, N., 47, 210, 390, 395-7, 436, 477,  
 636  
 Pitts, 619  
 Plancharde, 280  
 Poel, 338  
 Poelchen, 581, 586, 590, 591  
 Poland, 157, 273, 302-4, 306, 310, 430  
 Pollailon, 168  
 Pollard, Bilton, 186, 188, 384  
 Pollock, 157, 160, 172  
 Porak, 294  
 Porges, 246  
 Port, 608, 610  
 Portarca, 139  
 Postempski, 180  
 Postnikow, 257  
 Potain, 87  
 Poulet, 17, 30, 33, 167, 171, 572  
 Poulsen, 142  
 Poulton, 617  
 Powell, 464  
 Power, 448  
 Preble, 30  
 Price, Parry, 62  
 Prideaux, 607, 610  
 Puech, 46  
 Pullin, 379  
 Purton, 113, 115, 116  
 Puzey, 317
- QUAIN, 613  
 Quénu, 140, 640
- RABAGLIATI, 362  
 Ransom, 413  
 Ratcliffe, J. R., 49  
 Rawdon, 263  
 Ray, 182



- Reclus, 554  
 Reher, 48, 70  
 Rehn, 685, 686, 692  
 Reichmann, von, 43, 121, 156  
 Rennie, 695  
 Renton, T. Crawford, 202, 386  
 Renvers, 75, 94, 156  
 Repetto, 162  
 Reverdin, 476  
 Ribbert, 489  
 Ricard, 418  
 Richardson, B. W., 74  
 Richardson, Maurice, 31, 35, 36, 507, 508  
 Richelot, 601  
 Richter, 166, 692  
 Ricord, 661  
 Ridley, G. W., 386  
 Rieder, 394  
 Riegel, 413, 414  
 Ritchie, 172  
 Rizzoli, 665  
 Roberts, 323  
 Roberts, John B., 642, 644, 645  
 Robertson, 295, 296  
 Robinson, F. B., 257, 538, 540  
 Robinson, H. Betham, 433  
 Robson, Mayo, 175, 198, 226, 307, 390, 392, 402, 403, 408, 436, 447, 449, 474, 540, 547  
 Rochard, 444  
 Rockwell, 306  
 Rockwitz, 251  
 Rodman, C. H., 77  
 Roe, 99  
 Rohé, 368  
 Rokitansky, 56, 57  
 Rolleston, W. D., 84, 114, 289, 294, 397, 422, 439, 480  
 Roosevelt, 61, 65, 66, 71  
 Roper, 278  
 Rosenbach, 82  
 Rosenheim, 227  
 Rosenthal, 389  
 Roughton, E. W., 386  
 Roupell, 228  
 Routier, 680  
 Roux, 452  
 Rowan, 661  
 Rowland, Sidney, 330  
 Rumpel, 289  
 Rushmore, 498  
 Russell, 172  
 Rutherford, H., 24, 415, 416  
 Rydygier, 220, 221, 685, 686, 690
- Sands, 93  
 Sansom, 695  
 Saundby, 149  
 Schech, 39  
 Schede, 689  
 Scheimpflug, 239  
 Scherming, 497  
 Schiach, 339  
 Schiltz, 80  
 Schmidt, 626, 629  
 Schoening, 613  
 Schönborn, 172  
 Schroeder, 409, 410  
 Schwartz, 444  
 Scott, 323  
 Sédillot, 232  
 Sellow, 438  
 Senator, 78, 97  
 Sendler, 465  
 Senn, 252, 253, 255, 256, 260, 263, 322, 344, 345, 452, 535, 537, 556  
 Sharkey, 27, 55, 436  
 Shattock, 126, 127, 605, 606  
 Shaw, Lauriston, 83, 206, 207, 209, 447  
 Sheild, Marmaduke, 604, 605  
 Shepherd, 386  
 Silcock, A. Q., 188, 189  
 Silver, 20  
 Simmons, 572, 574  
 Simon, 342, 566  
 Sinclair, 66  
 Smith, Eustace, 444, 481  
 Smith, Greig, 222, 232, 235, 411, 412, 418, 549  
 Smith, Henry, 641, 643, 676  
 Smith, L., 364  
 Smith, Parsons, 607  
 Smith, Pye, 351, 384, 460  
 Smith, T., 603, 605  
 Smith, Walter, 65, 71  
 Southam, 286, 288, 295, 296, 363, 456  
 Spanton, 572, 576  
 Squires, 457  
 Ssabanejew, 244  
 Stalkert, 571  
 Stanley, 390  
 Stansfield, 260  
 Steavenson, 136  
 Steele, 126, 127  
 Stephan, 58, 84  
 Steven, Lindsay, 207, 219, 415  
 Stierlin, 612, 614  
 Stimson, 307, 317, 319, 323, 516  
 Stockwell, 65  
 Stoker, Thornley, 512  
 Stretton, J. L., 386  
 Struthers, 119, 489  
 Surmay, 295  
 Sutcliffe, 449

- Sutherland, Lewis, 517  
 Sutton, 166, 422  
 Swenson, 281  
 Swain, Paul, 222, 268, 665  
 Syme, 32, 34  
 Symington, 634  
 Symonds, 75, 77, 79, 94, 447, 449, 468  
 Sympson, 571  
  
 TALAMON, 516  
 Targett, 83, 304, 437  
 Taylor, F. W., 126  
 Taylor, Joseph, 29  
 Taylor, J. W., 187, 189, 209  
 Taylor, W. C. E., 403, 404, 408, 417  
 Templeton, 306, 309  
 Terrier, 671  
 Terrillon, 96, 406, 408  
 Thiersch, 101  
 Thiéry, 363  
 Thiriari, 408  
 Thomas, Hugh, 19  
 Thomas, Wm., 423  
 Thomson, H., 364  
 Thomson, John, 422, 423  
 Thomson, J. H., 570  
 Thomson, R. E., 382, 385  
 Thomson, Wm., 22  
 Thorndike, 691  
 Thornton, Knowsley, 172  
 Thornton, W. P., 65  
 Tietze, 96, 96  
 Tiffany, 164, 324  
 Tirard, 482  
 Tito-Carbone, 411  
 Tooth, 435  
 Townley, P. L., 571  
 Traube, 154  
 Trélat, 444, 670  
 Tremaine, 319  
 Trendelenburg, 102, 557  
 Treves, Frederick, 107, 174, 175, 182, 222, 226, 268, 272, 355, 361, 375, 393, 396, 401, 404, 405, 409, 425-7, 438, 439, 444, 455, 458, 507, 508, 510, 514, 523, 526, 557, 559, 632, 642, 647  
 Troisier, 204  
 Tuholske, 265  
 Turner, F. Charlewood, 126, 128, 129, 421  
 Turner, G. R., 392  
  
 UHLMANN, 692  
  
 VERNEUIL, 642, 679, 693  
 Vernon, H., 408  
 Verral, 386  
  
 Vince, J. Foster, 126, 128  
 Viti, 50, 115  
 Voelhs, 339, 340, 341, 394  
 Voelcker, 133  
 Voigt, 89  
 Volkmann, 629, 646  
 Voss, 607  
  
 WAGSTAFFE, 616  
 Walker, 477  
 Wallis, 281  
 Walsham, 450, 566  
 Walters, J. H., 186, 189  
 Warren, 572  
 Wasker, van de, 21  
 Way, 617  
 Weichselbaum, 53, 54, 468  
 Weinlechner, 86, 92, 121, 123  
 Weir, Robert F., 140, 224, 225, 247  
 Wepfer, 104  
 West, 193, 205, 281, 369  
 Whipham, 195  
 White, Hale, 210, 410, 434, 436, 484  
 White, J. A. H., 306, 310  
 White, J. William, 24, 344  
 Whitehead, 123  
 Whitla, 97  
 Whitmore, 599  
 Whittier, 289  
 Wiggan, 306, 311  
 Wilks, 43, 47, 61, 87, 113, 116, 128, 129, 419, 432, 450  
 Willems, 690  
 Willet, 422  
 Williams, Alfred, 22  
 Williams, John T. C., 383, 463, 612  
 Williamson, 311  
 Wilms, 80  
 Wilson, Andrew, 158  
 Wilson, Arthur H., 164  
 Wilson, J. Stacy, 49  
 Wilson, Prof., 104  
 Witzel, 232, 242-4, 690  
 Wölfler, 199, 200, 220, 221, 223, 249, 254, 255, 529, 687, 688  
 Woods, 277  
 Wooldridge, 180  
 Woolsey, 101, 323  
 Worrall, 455  
 Wright, G. A., 363  
 Wyatt, 61  
 Wyss, 55  
  
 YARR, 274  
  
 ZEMANN, 53  
 Zenker, Konrad, 51, 53, 88, 113, 120, 125, 131  
 Ziemssen, von, 53, 56, 125, 129, 355  
 Zuckerkandl, 687, 688

# INDEX OF SUBJECTS



- ABRE's catgut rings in intestinal co-aptation, 256  
 — string method in cicatricial stenosis of œsophagus, 100  
 — suture in bowel union, 531  
 Abnormalities of intestine, great, 480  
 — of intestine, small, 420  
 — of œsophagus, 112  
 — of rectum, 654  
 Abscess due to appendicitis, 501, 502, 493  
 — — treatment of, 510, 513  
 — due to carcinoma, great intestine, 467, 472  
 — — rectum, 617  
 — due to contusion, small intestine, 303  
 — — diverticulum of rectum, 671  
 — — duodenal ulcer, 281  
 — — foreign body in intestine, 330  
 — — gunshot wound of intestine, 322  
 — in liver due to carcinoma of great intestine, 468, 470  
 — localised, result of tubercular ulceration, small intestine, 341  
 — localised, result of typhoid ulceration, small intestine, 341  
 — perinephric, ulcerating into duodenum, 295  
 — perirectal, 569, 575, 592  
 — post-œsophageal, 20, 21  
 — post-cæcal, 468  
 — pressure of, affecting œsophagus, 131, 132  
 — — giving rise to intestinal obstruction, 418  
 — result of perforation, small intestine, 398  
 — rupturing into rectum, 673  
 — secondary to gastric ulcer, 192  
 — — to carcinoma of stomach, 205  
 — — to stricture of great intestine, 439  
 — — to stricture of rectum, 670  
 — subdiaphragmatic, 193  
 — submucous, of œsophagus, 46  
 Abscess in ulcer, perforated, great intestine, 432, 437  
 — — stercoral, great intestine, 457  
 — in ulceration, tubercular, of rectum, 583  
 Absorption, fæcal, in fæcal accumulation, 458  
 Accumulation, fæcal, great intestine, 455  
 — — as a cause of proctitis, 577  
 — — — stricture of rectum, 591  
 — — — ulceration of rectum, 581  
 Acid, carbolic, injection of, as a cause of proctitis, 577  
 — nitric, in rectal prolapse, 641  
 — tannic, in rectal prolapse, 641  
 Acids as a cause of stenosis of œsophagus, 85  
 Actinomycosis as a cause of appendicitis, 496  
 Adenomata of great intestine, 462  
 — of small intestine, 411  
 — of œsophagus, 55  
 — of rectum, 602  
 — of stomach, 202  
 Adeno-sarcoma of great intestine, 477  
 Adenoid carcinoma of great intestine, 466  
 — — of rectum, 614  
 Adhesion between layers in intussusception, 377  
 Adhesions in appendicitis, 514  
 — in gastric ulcer, 198  
 — of stomach, giving rise to dilatation, 226  
 — in acute strangulation, 368, 446  
 — in stricture, small intestine, 398  
 — in volvulus, 390, 450  
 Albert's modification of jejunostomy, 523  
 Alimentation, rectal, 693  
 Alkalies, caustic, as a cause of stenosis of œsophagus, 85  
 Amputation of rectal prolapse, 646  
 Amussat's operation of colostomy, 544

- Anæsthetic in impacted foreign body of œsophagus, 28
- Anatomy, surgical, of appendix vermiformis, 489
- — intestine, great, 425
  - — — small, 271, 297
  - — œsophagus, 1
  - — rectum, 561
  - — stomach, 145
- Aneurysm, aortic, causing pyloric obstruction, 209, 226
- — differential diagnosis, from carcinoma of œsophagus, 69
  - aorta, pressure of, on œsophagus, 131
- Angioma, lipomatous, of great intestine, 463
- Angiomata of rectum, 608
- Anus, artificial, closure of, 555
- — formation of (method), 550
  - — — in atresia recti, 666
  - — — in carcinoma of great intestine, 476
  - — — in carcinoma of rectum, 624, 630, 633, 634
  - — — in dilatation, great intestine, 479, 480
  - — — in dysentery, 579
  - — — in intussusception, 387
  - — — occlusion of bowel, 422
  - — — in rupture of bowel, 312
  - — — in strangulation, internal, 365
  - — — in stricture, intestinal, 400
  - — — of rectum, 593, 601
  - — — in ulcer, typhoid (perforated), 347
  - — — in ulceration of rectum, 583
  - — — in volvulus, 392
  - — — in wounds, small intestine, 317
  - — previous to proctectomy, 680
  - — result of injury to bowel and abdominal wall, 303
  - condition of, in carcinoma of rectum, 618
  - lumbar, formation of, 554
  - sacral, in carcinoma of rectum, 634
  - sigmoid, formation of, 550
  - — in atresia recti, 663
  - — in carcinoma of rectum, 635, 669
- Aorta, dilated, causing dilatation of œsophagus, 112
- perforated by bone impacted in œsophagus, 22
  - rupture of, by œsophageal probang, 32
  - ulceration of œsophageal carcinoma extending into, 65
- Apertures, adventitious or congenital, strangulation through, 351
- Aphonia in carcinoma of œsophagus, 66, 71
- Aphthous œsophagitis, 44
- Appendiceectomy, operation of, 557
- reference to, 505, 508, 510
- Appendices epiploicæ, anatomy of, 427
- lipomata in connection with, 463
  - strangulation caused by, 356
- Appendicitis, 491
- diagnosis of, 503
  - etiology of, 494
  - pathology of, 492
  - prognosis of, 506
  - symptoms of, 497
  - treatment of, 509
- Appendix, vermiformis, 489
- anatomy of, 489
  - carcinoma of, 516
  - cystic disease of, 517
  - foreign bodies of, 491, 496
  - inflammation of, 491
  - removal of, 557
  - situation of, 490
  - strangulation caused by, 356, 361, 364, 370
  - structure of, 490
- Ascaris lumbricoides in stomach, 166
- Aspiration of stomach, 229
- Astringent injections in rectal prolapse, 641
- Atresia ani, 657
- congenital, of œsophagus, 126
  - recti, 657
- Atrophy, muscular, causing dilatation of œsophagus, 113
- BACILLUS coli communis in appendicitis, 495
- Bags, elastic, for dilating œsophagus, 33
- 'Ballooning' of bowel in obstruction, 443
- of rectum from stricture, 593, 596, 618
- Bands, strangulation by, 354
- Bartholin's glands, inflammation of, giving rise to ulceration of rectum, 586
- Bernay's curettage of pylorus, 268
- Bishop's suture in bowel union, 530
- Bladder affected in appendicitis, 501
- fistulous, communication between appendix and, 493, 514
  - — communication between colon and, 467, 472, 484
  - — communication between rectum and, 575, 592, 617, 634

- Bladder, foreign body, intestinal, rupturing into, 334  
 — pressure on, in fæcal accumulation, 456  
 — rectum opening into (congenital), 657, 660, 665  
 — stone in, as a cause of rectal prolapse, 638  
 — tumours of, pressing on rectum, 676
- Blood, defibrinated, as a nutrient enema, 695
- Blow on abdomen, as a cause of volvulus, 390  
 — — resulting in stricture, 396
- Bobbins, bone, bowel union by, 540
- Bone bobbins, union by (Robson's), 540  
 — plates, union by (Senn's), 535  
 — tubes, union by (Littlewood's), 537
- Borelius' method of proctectomy, 687
- Bougie, hollow, in removing fish bone from œsophagus, 34  
 — in atresia of œsophagus, 127  
 — in paralysis of œsophagus, 105  
 — in treatment of diverticulum of œsophagus, 124  
 — in treatment of impacted foreign body of œsophagus, 23, 31, 32  
 — in treatment of cicatricial stenosis of œsophagus, 93  
 — in treatment of congenital stenosis of œsophagus, 129  
 — in treatment of spasm of œsophagus, 110
- Bougies, injury to rectum by, 568  
 — introduction of, in affections of œsophagus, 134  
 — use of, in rectal affections, 667  
 — — in stricture of rectum, 594, 593, 622
- Bowel union, 528
- Brain, secondary involvement of, in carcinoma of rectum, 619
- Branchial cleft, non-closure of, as a cause of diverticulum of œsophagus, 117
- Brokaw's rubber rings in intestinal coaptation, 256
- Bronchocele, substernal, pressing on œsophagus, 132
- Brunner's glands, 272, 284, 293
- Bullet, difference in wound according to nature of, 320, 327
- Burns as a cause of acute duodenal ulceration, 284  
 — of œsophagus, 4
- Buttock, rectum opening into, 657
- Button, Murphy's, description of, 256  
 — bowel union by, 541
- CACHEXIA in carcinoma of rectum, 619, 634
- Cæcectomy, operation of, 546
- Cæcitis, 431
- Cæcum, anatomy of, 425  
 — fæcal accumulation at, 455  
 — fibroma of, 463  
 — misplacement of, 482  
 — rupture of, 617  
 — ulcer of, 434, 437
- Callisen's operation of colostomy, 544
- Carcinoma of appendix, 516  
 — of duodenum, 289  
 — of intestine, great, 464  
 — of intestine, small, 412  
 — of liver simulating obstruction of œsophagus, 70  
 — of liver as a cause of spasm of œsophagus, 107  
 — of œsophagus, 58  
 — of pylorus, 209  
 — of rectum, 612  
 — of stomach wall, 202
- Catarrhal appendicitis, 493  
 — œsophagitis, 46  
 — ulcer of great intestine, 437
- Catheter, railway, in œsophageal stenosis, 96
- Catheterisation in diverticula of œsophagus, 124
- Cauterisation in carcinoma of œsophagus, 80
- Cautery, thermo-, in gastric ulcer, 181  
 — in rectal prolapse, 643, 693
- Cellulitis of perirectal tissue, 580  
 — pelvic, rupturing into rectum, 674
- Cervical œsophagotomy, 137
- Chaput's operation for closure of artificial anus, 555
- Cholecyst-enterostomy, operation of, 560
- Chorea in spasm of œsophagus, 107
- Cicatricial stricture of duodenum, 291  
 — intestine, great, 438  
 — — small, 393  
 — œsophagus, 84  
 — rectum, 590
- Cicatrisation of gastric ulcer, effects, 200
- Cirrhosis of liver as a cause of varix of œsophagus, 49
- Clamp and cautery in rectal prolapse, 643, 693
- Clavicle, dislocation of, pressing on œsophagus, 131
- Coin in œsophagus, 19, 24, 26, 27  
 — — cases of, 35
- Coin catcher, description of, 25, 31, 32
- Colectomy, operation of, 546

- Colectomy in carcinoma, great intestine, 474
- Colic, appendicular, 498
- variety of intussusception, 447
- Colitis, 431
- membranous, 436, 438
- ulcerative, 435
- Collapse after gastro-enterostomy, 258
- Colloid carcinoma of intestine, great, 465
- of œsophagus, 62
- of rectum, 615
- Colon (*see* Intestine, great)
- Colopexy, operation of, 550
- in rectal prolapse, 652
- Colo-rectostomy, of Uhlmann, 692
- Colostomy, operation of, 544
- in atresia recti, 666
- in carcinoma, great intestine, 473, 476
- in fæcal accumulation, 460
- in ulcerative colitis, 436
- in volvulus, great intestine, 452
- Colostomy, gastro-, operation of, 248
- Colotomy, operation of, 544
- Concretions of rectum, 573
- Congenital abnormalities of intestine, great, 480
- of intestine, small, 420
- of œsophagus, 112
- of rectum, 654
- Constipation in carcinoma of rectum, 620
- as a cause of rectal prolapse, 638
- Contusion of intestine, small, 300
- of stomach, 156
- Convulsions in fæcal accumulation, 457
- Crédé's rectal bougie, 598
- Cripps' operation for sigmoid anus, 552
- Croupous œsophagitis, 46
- Cryptoscope in impacted foreign bodies in œsophagus, 24
- Curetting in carcinoma of rectum, 632
- in pyloric obstruction, 215, 224, 268
- Curvature, spinal, affecting œsophagus, 134
- Cystenterostomy, 560
- Cystic disease of appendix, 517
- Cystoma, ovarian, giving rise to intestinal obstruction, 418
- Cystomata of rectum, 607, 610
- Cysts of intestine, great, 464
- — small, 411
- of œsophagus, 55
- of stomach, 202
- Czerny, Lembert suture in bowel union, 529
- Davy's lever, injury to rectum by, 568
- Deformities of œsophagus, 125
- Dermoid tumours of intestine, great, 463
- — — rectum, 608, 610
- Diaphragmatic hernia, 444, 481
- Diarrhœa as a cause of prolapse of rectum, 638
- — of ulceration of rectum, 581
- from foreign body in rectum, 575, 576
- spurious in carcinoma of rectum, 620
- Digital examination of rectum, 565
- dilatation of pylorus, 267
- Dilatation, digital, of pylorus, 267
- of intestine, great, 477
- — small, 398, 414
- of œsophagus, 112
- of rectum, 592, 616
- of stomach, 213, 224, 290
- Dilators, tupelo wood, in stenosis of œsophagus, 97
- Diphtheria as a cause of paralysis of œsophagus, 104
- Diphtheritic proctitis, 577
- ulceration of rectum, 581
- Distension of stomach for examination purposes, 154
- Distortion of œsophagus, 134
- Diverticula of intestine, great, 483
- of œsophagus, 117
- excision of, 141
- of rectum, 670
- Diverticulum of jejunum, 422
- Meckel's varieties of, 421
- result of stricture, small intestine, 398
- of stomach, 210
- strangulation by, 356
- Douglas' pouch, drainage of, in perforated typhoid ulcer, 346
- Drainage, open, in perforated gastric ulcer, 187
- of peritoneal cavity in perforated gastric ulcer, 189
- Duodenectomy, operation of, 296
- Duodenoplasty, operation of, 296
- Duodenostomy, operation of, 295
- gastro-, operation of, 248
- in carcinoma of stomach, 206, 208
- in pyloric obstruction, 215, 223
- Duodenotomy, operation of, 296
- Duodenum, anatomy of, 271
- carcinoma of, 289
- fibro-myxomata of, 288
- foreign bodies of, 276
- injuries of, 273
- obliteration of, 293
- operations on, 295

- Duodenum, perforations of, 280, 287, 291  
 — rupture of, 273  
 — sarcoma of, 289  
 — stenosis of, 291  
 — tumours of, 288  
 — ulcer, simple, of, 277  
 — ulceration, acute, of, 284  
 Dysenteric proctitis, 578  
 — ulcer, intestine, great, 435  
 — ulceration of rectum, 581  
 Dysentery as a cause of stricture of rectum, 591
- EAR affections in spasm of œsophagus, 107  
 Egebert's method of fixing stomach in gastrostomy, 232  
 Electricity in treatment of paralysis of œsophagus, 105  
 — — of spasm of œsophagus, 111  
 Electrolysis in stricture of œsophagus, 97  
 — — of rectum, 599, 693  
 — operation of, in œsophageal affections, 136  
 Embolic appendicitis, 494  
 Emesis in impacted foreign bodies of œsophagus, 29  
 Emphysema in traumatic rupture of ileum, 309  
 — in œsophageal perforation, 21  
 Empyema rupturing into œsophagus, 133  
 — secondary to gastric ulcer, 192  
 Encephaloid carcinoma of duodenum, 289  
 — intestine, great, 466  
 — œsophagus, 62  
 — rectum, 613, 615  
 Endoscope, electro-, use of, in impacted foreign bodies of œsophagus, 24  
 Enemata, anthelmintic, 697  
 — astringent, 697  
 — in appendicitis, 512  
 — in carcinoma, great intestine, 471, 476  
 — in fœcal accumulation, great intestine, 460  
 — in rectal prolapse, 642  
 — in rectal stricture, 594, 622  
 — in volvulus, great intestine, 451  
 — nutrient, 694  
 — purgative, 697  
 — sedative, 698  
 — uses of, 677  
 Enterectomy, operation of, 526  
 Enteric variety of intussusception, 372  
 Enteritis, acute, 301  
 Enteritis, chronic, 301  
 — as a cause of intestinal obstruction, 420  
 Entero-anastomosis, methods of, 527  
 Entero-enterostomy, operation of, 543  
 Enterolith in appendix, 496  
 Entero-lithotomy, operation of, 406  
 Enteroliths, 409, 453  
 Enteroplasty, operation of, 543  
 — in stenosis, intestine, great, 443  
 — — — small, 397, 401  
 Enterostomy, operation of, 522  
 — gastro-, operation of, 248  
 Enterotomy, operation of, 522  
 — in obstruction due to gall-stone, 405  
 Epilepsy as a cause of spasm of œsophagus, 107  
 Epithelioma of duodenum, 289  
 — of intestine, great, 465  
 — — small, 412  
 — of œsophagus, 58  
 — — extending into stomach, 207  
 Erysipelatous proctitis, 577  
 Ewald's method of obtaining gastric juice for examination, 149  
 Excision, elliptical, in rectal prolapse, 644  
 — of anus, artificial, 556  
 — of carcinoma, great intestine, 474  
 — of diverticulum of œsophagus, 124  
 — — of rectum, 671  
 — of gastric ulcer (non-perforated), 179  
 — of gastric ulcer (perforated), 185  
 — of intestine (enterectomy), 526  
 — of intussusception, 383  
 — of obstruction, gall-stone, 407  
 — of pylorus, 260  
 — of rectum, 624, 590  
 — of rupture, intestine, small, 311, 317, 323  
 — of sarcoma, intestine, small, 416  
 — of stricture, intestine, small, 401, 414  
 — — rectum, 600  
 — of tumour, intestine, 419  
 — of tubercular disease, intestine, 434  
 — of ulcer of rectum, 589  
 — of volvulus, 392, 452  
 Exostosis of vertebræ, pressure of, on œsophagus, 132  
 Extractors, introduction of, in affections of œsophagus, 134
- FÆCES, character of, in carcinoma of rectum, 620  
 — — — of sigmoid flexure, 469, 471  
 — — in stricture of rectum, 593

- Fæces, incontinence of, after proctectomy, 627
- Fallopian tube as a cause of intestinal strangulation, 356
- Fibromata of intestine, great, 463
- — small, 410
- of œsophagus, 55
- of rectum, 603, 610
- of stomach, 201
- of uterus, giving rise to intestinal obstruction, 418
- — giving rise to rectal obstruction, 674
- Fibro-myoma of intestine, great, 463
- — of stomach, 201
- Fibro-myxoma of duodenum, 288
- Fistula, bimucous, in gastro-enterostomy, 260
- faecal, in appendicitis, 514
- — in dilatation, intestinal, 480
- — in gall-stone obstruction, 407
- — intussusception, 388
- — in stricture, intestinal, 398, 401, 414
- — — rectal, 670
- — in ulcer, duodenal, 281
- — in wounds, gunshot, 322
- — closure of, 555
- from foreign body in rectum, 575
- gastric, in gastro-enterostomy, 259
- — in ulcer, gastric, 187, 196
- — in wounds, gunshot, 164
- — treatment of, 160
- — in ano in carcinoma, rectal, 617
- — recto-vesical in carcinoma of rectum, 617, 634
- — umbilical, relation of, to permanence of vitelline duct, 421
- Fixation of bowel in sigmoid anus, 551
- Follicles, lymphoid, of rectum, 563, 606
- simple, of intestine, great, 428
- solitary lymph, in appendix, 491
- Follicular colitis, 438
- œsophagitis, 46
- Foramen of Winslow, hernia into, 350
- Forceps, introduction of, in œsophageal affections, 134
- use of, in œsophageal affections, 32
- Foreign bodies in appendix, 496
- — in duodenum, 276
- — in intestine, great, 328
- — in intestine, small, 328
- — in œsophagus, 16
- — — as a cause of diverticula, 119
- — in rectum, 571
- — — as a cause of proctitis, 573, 577
- — — — of stricture, 591
- Foreign bodies in rectum as a cause of ulceration, 581
- — in stomach, 164
- Fossa, duodeno-jejunal, hernia into, 350
- intersigmoid, hernia into, 350
- pericæcal, hernia into, 350
- Frank's modification of gastrostomy, 244
- Fungous carcinoma of duodenum, 289
- GALL-BLADDER, distension of, in malignant disease, duodenum, 290
- — causing pyloric obstruction, 209
- Gall-stone in appendix, 496
- ulcerating into stomach, 210
- Gall-stones, obstruction of great intestine by, 453
- — of small intestine by, 401
- stenosis of duodenum due to, 292
- volvulus due to, 390
- Gangrene of appendix, 493
- of intestine, small, from contusion, 302
- Gastrectasia, 156
- Gastrectomy, operation of, 244
- Gastric fistula (*see* Fistula)
- juice, method of obtaining for examination, 149
- — method of detection of free hydrochloric acid, 151
- — method of determining rate of absorption, 151
- — variability of digestive properties, 292
- ulcer (*see* Ulcer), 176
- — diagnosis from varix of œsophagus, 50
- Gastritis, acute, 157
- Gastro-anastomosis, 200
- Gastro-colostomy, 248
- Gastrodiaphany, 155
- Gastro-enterostomy, operation of, 248
- combined with pylorotomy, 265
- in pyloric obstruction, 215, 220
- Gastro-ileostomy, 248
- Gastro-jejunostomy, 248
- Gastroliths, 172
- Gastropexy, operation of, 248
- reference to, 225
- Gastroplication, 248
- Gastroptosis, 156, 248
- Gastrorrhaphy, operation of, 247
- in a case of dilatation of stomach, 225
- Gastroscopy, 155
- Gastrostomy, operation of, 232
- — Frank's, 244



- Gastrostomy, operation of, Von Hacker's, 240  
 — — Hahn's, 241  
 — — Witzel's, 242  
 — in atresia of œsophagus, 127  
 — in carcinoma of œsophagus, 74, 78, 81, 82  
 — in diverticula of œsophagus, 123  
 — in pyloric obstruction, 215, 223  
 — in stricture of œsophagus, 95, 102  
 Gastrotomy, operation of, 230  
 — — for extraction of foreign bodies, stomach, 171  
 — — — œsophagus, 35  
 — in œsophageal stenosis, 97  
 Gersuny's tubage in carcinoma of œsophagus, 77  
 Glands, Brünner's, 272, 298  
 — lumbar, in carcinoma of rectum, 618, 621, 634  
 — mesenteric, causing pyloric obstruction, 209  
 — — in carcinoma, great intestine, 469  
 — — in sarcoma, intestinal, 416, 418  
 — — tubercular, dragging stomach, 227  
 — pressing on œsophagus, 131  
 — retro-peritoneal pressing on duodenum, 290  
 — sacral, in carcinoma of rectum, 618, 621, 634  
 — solitary, 273, 299, 428  
 — — in tubercular ulcer, 339  
 — — in typhoid ulcer, 341  
 — supraclavicular, in carcinoma of stomach, 204  
 Glénard's disease, 227  
 Gluteus maximus, fibres of, as a sphincter in proctectomy, 690  
 Goitre causing pressure on œsophagus, 132  
 Gonorrhœa as a cause of ulceration of rectum, 581  
 Gonorrhœal proctitis, 577  
 Gout as a cause of spasm of œsophagus, 107, 111  
 — — of stricture of œsophagus, 89  
 Gunshot wounds, intestinal, 319  
 Günzburg's method for detection of free hydrochloric acid in gastric juice, 151
- HACKER'S, VON, operation of gastrostomy, 240  
 Hæmorrhage after gastro-enterostomy, 259  
 — after lavage of stomach, 229  
 — in angiomas of rectum, 608  
 — in appendicitis (from iliac vessels), 493
- Hæmorrhage in carcinoma, duodenum, 290  
 — — rectum, 620  
 — — sigmoid flexure, 469, 471  
 — — stomach, 204  
 — in duodenal ulcer, 279  
 — in dysenteric ulcer, 435  
 — in gastric ulcer, 180  
 — in injury, rectal, 569, 573  
 — — in intra-abdominal, 306, 316  
 — in intussusception, cause of, 376, 396  
 — — colic, 448  
 — in papilloma, great intestine, 462  
 — — rectum, 605, 610  
 — in proctitis, 578  
 — in prolapse of rectum, 640  
 — in thrombosis, mesenteric vessels, 487  
 Hæmorrhoids, as a cause of prolapse of rectum, 638  
 — in carcinoma of rectum, 618  
 Hahn's operation of gastrostomy, 241  
 Hair tumours of stomach, 172  
 Halsted's suture in bowel union, 535  
 Heart, enlarged auricles of, pressing on œsophagus, 131  
 — injury to, from fish bone in œsophagus, 22  
 — pressure on, in fœcal accumulation, 456  
 — — in dilatation of colon, 478  
 Hegar's method of proctectomy, 686  
 Heineke's method of proctectomy, 685  
 — Mikulicz, pyloroplasty, 215, 265  
 Hepatic colic, simulating appendicitis, 503  
 Hernia, internal, of great intestine, 444  
 — of small intestine, 350  
 — — diagnosis of, 361  
 — — symptoms of, 358  
 — — treatment of, 362  
 — rectal, 654  
 — reduced and causing stricture, 395, 397  
 Hiccough, persistent, after gastro-enterostomy, 258  
 Hour-glass contraction of stomach, 200  
 Houston's folds of rectum, 563  
 Humerus, involvement of, in carcinoma of rectum, 619  
 Hydatid cyst causing pyloric obstruction, 209  
 — of meso-colon (rectal), causing obstruction, 676  
 Hydrochloric acid, absence of free, in carcinoma of stomach, 203, 213

- Hydrochloric acid, administration of, in a case where razor was swallowed, 168, 171  
 — detection in gastric juice (*see* Gastric), 151  
 Hydrogen gas, inflation of bowel by, 322  
 Hysteria, spasm of œsophagus in, 107
- IDIOPATHIC œsophagitis, acute, 38  
 Ileo-cæcal valve, 429  
 — abnormalities of, 485  
 — cystic dilatation of, 464  
 — orifice constricted as a cause of intussusception, 375  
 Ileo-colostomy, operation of, 543  
 — in carcinoma of great intestine, 476  
 Ileo-ileostomy, operation of, 543  
 Ileostomy, operation of, 525  
 — in carcinoma of great intestine, 476  
 Ileotomy, operation of, 522  
 Ileum (*see* Intestine, small)  
 — fistulous communication between colon and, 467  
 — opened instead of jejunum in gastro-enterostomy, 260  
 Ileus paralyticus, 458  
 Iliac vein, thrombosis of, in appendicitis, 493  
 Impacted foreign bodies, œsophagus, 16  
 Impaction, fæcal, rectum, 572  
 Inanition after gastro-enterostomy, 259  
 Inflation in intussusception, 383  
 — of stomach for examination purposes, 154  
 Inguinal colostomy, 546  
 Injection in intussusception, 384  
 Injuries of duodenum, 273  
 — intestine, great, 430  
 — — small, 300  
 — rectum, 567  
 — stomach, 156  
 Innervation, irregular, as a cause of intussusception, 375  
 Intestinal neuroses, 424  
 — obstruction (*see* Intestine)  
 — after gastro-enterostomy, 259  
 Intestine, great, abnormalities of, 480  
 — — accumulation, fæcal, of, 455  
 — — adenoma of, 462  
 — — anatomy of, 425  
 — — carcinoma of, 464  
 — — contusions of, 430  
 — — cysts of, 464  
 — — dermoids of, 463  
 Intestine; great, dilatation, congenital, 478  
 — — fibroma of, 463  
 — — fibro-myoma of, 463  
 — — foreign bodies of, 328  
 — — idiopathic, dilatation of, 477  
 — — inflammation of, 431  
 — — injuries of, 430  
 — — intussusception of, 447  
 — — kinking of, 446  
 — — lipoma of, 463  
 — — maldevelopment of, 483  
 — — misplacement of, 481  
 — — nerve supply of, 429  
 — — papilloma of, 462  
 — — perforation of, 617  
 — — physiology of, 430  
 — — rupture, traumatic, of, 430  
 — — sarcoma of, 476  
 — — strangulation, internal, of, 444  
 — — stricture, cicatricial, of, 438  
 — — structure of, 427  
 — — tumours of, 461  
 — — ulceration of, 431  
 — — vascular supply of, 428  
 — — volvulus of, 449  
 — — wounds of, 313  
 — — — gunshot, 319  
 Intestine, small, abnormalities of, 421  
 — — adenomata of, 411  
 — — anatomy of, 297  
 — — carcinoma of, 412  
 — — contusions of, 300  
 — — cysts of, 411  
 — — diverticulum of jejunum, 422  
 — — diverticulum, Meckel's, 421, 356  
 — — diverticulum from stricture, 398  
 — — enteroliths, 409  
 — — epithelioma of, 412  
 — — fibromata of, 410  
 — — foreign bodies of, 328  
 — — gall stones in, 401  
 — — hernia, internal, of (*see* Hernia), 350  
 — — imperforate, 422  
 — — inflammation of, 301  
 — — injuries of, 300  
 — — intussusception, 371  
 — — kinking of, 368  
 — — lipoma of, 411  
 — — lymphadenoma of, 416  
 — — lymphatic system of, 299  
 — — lymphoma of, 416  
 — — malformations of, 421  
 — — Meckel's diverticulum (*see* Diverticulum)  
 — — myomata of, 410  
 — — nerve supply of, 299  
 — — obstruction of, 349  
 — — occlusion, membranous, of, 421

- Intestine, small, operations on, 522  
 — — physiology of, 300  
 — — polypi of, 410, 414  
 — — rupture of, 305  
 — — sarcoma of, 414  
 — — sloughing of, 302  
 — — stricture, cicatricial, of, 393  
 — — — congenital, 421  
 — — structure of, 297  
 — — transposition of, 422  
 — — tumours of, 410  
 — — ulceration of, 302, 339, 341  
 — — vascular supply of, 299  
 — — vitelline duct of, 421  
 — — volvulus of, 389  
 — — wounds of, 313  
 — — — gunshot, 319
- Intussusception of intestine, great, 447  
 — small, 371  
 — — anatomy, pathological, of, 372  
 — — causes of, 374  
 — — symptoms of, 379  
 — — treatment of, 382  
 — — varieties of, 372  
 — of rectum, 653  
 — — in carcinoma, 618  
 — — of polypi, 611
- Iron sulphate in rectal prolapse, 641
- JAUNDICE in malignant disease of duodenum, 290
- Jejuno-ileostomy, operation of, 543
- Jejuno-jejunostomy, 543
- Jejunostomy, operation of, 523  
 — gastro-, operation of, 248  
 — in carcinoma of stomach, 206  
 — in pyloric obstruction, 215, 223
- Jejunotomy, operation of, 522
- Jejunum, affections of (*see* Small intestine)
- Jessett's fixation of stomach in gastro-enterostomy, 236  
 — modification of jejunostomy, 523
- KIDNEY, displaced, as a cause of faecal accumulation, 459
- Kinking, causing strangulation, great intestine, 446  
 — — small intestine, 368
- Kleberg's operation in rectal prolapse, 648
- Kocher's method of proctectomy, 685
- Kraske's operation of proctectomy, 683  
 — case of, 634
- LAMINAR carcinoma of rectum, 613
- Laminaria, in malignant stricture of œsophagus, 78
- Lange's operation in rectal prolapse, 652
- Lavage of stomach, 215, 223
- Laparotomy (*see* under different affections)
- Larynx, affections of, as a cause of spasm of œsophagus, 107
- Laryngeal recurrent nerve, in carcinoma of œsophagus, 66, 71
- Lead poisoning as a cause of paralysis of œsophagus, 104
- Leube's meat emulsion in rectal alimentation, 694
- Levy's method of proctectomy, 685
- Lieberkühn, crypts of, in intestine, 298  
 — — in rectum, 563  
 — — relation to adenomata, 411
- Ligament, gastro-phrenic and gastro-splenic, relation to stomach, 145
- Lipomata of intestine, great, 463  
 — small, 411  
 — of mesentery as a cause of volvulus, 390  
 — of œsophagus, 51  
 — of rectum, 607  
 — of stomach, 201
- Lipo-myomata of stomach, 201
- Lithotomy, injury to rectum in, 568
- Liver, abscesses of, in appendicitis, 494, 501  
 — affections of, giving rise to pyloric obstruction, 209  
 — — carcinoma great intestine, 468  
 — — dulness, in rupture, small intestine, 308  
 — — involvement of, in carcinoma, great intestine, 469  
 — — in carcinoma of rectum, 618, 621, 634
- Loreta's digital dilatation of pylorus, operation of, 267  
 — references to, 215, 222
- Lumbar anus, formation of, 554  
 — colostomy, operation of, 544
- Lungs, involvement of, in carcinoma of rectum, 618
- Lymphadenoids of stomach, 201
- Lymphadenoma, great intestine, 477  
 — small intestine, 416
- Lymphatic system of great intestine, 428  
 — of small intestine, 299  
 — of rectum, 564
- Lymphoma of small intestine, 416  
 — of œsophagus, 84  
 — of rectum, 606

- Lympho-sarcoma of duodenum, 289  
 — of œsophagus, 84  
 — of neighbouring organs pressing on œsophagus, 132  
 — of stomach, 206
- MAGNESIA, mass of, giving rise to intestinal obstruction, 409
- Maisonneuve's urethrotome in œsophageal stenosis, 101
- Malformations of great intestine, 483  
 — of small intestine, 420  
 — of œsophagus, 125  
 — of rectum, 654
- Manipulation in treatment of œsophageal impacted foreign body, 28
- Massage in fœcal accumulation, 460  
 — — in volvulus (early), 451
- Maunsell's method of proctectomy, 692  
 — suture in bowel union, 532
- Maydl's modification of jejunostomy, 524
- Mayet's meat emulsion in rectal alimentation, 694
- McBurney's point in appendicitis, 500
- McLeod's operation in rectal prolapse, 651
- Meckel's diverticulum (*see* Diverticulum), 421
- Medulla, involvement of, in paralysis of œsophagus, 103
- Medullary carcinoma of intestine, great, 465  
 — of œsophagus, 62  
 — of rectum, 613  
 — of stomach, 203
- Melæna in duodenal ulcer, 279
- Melanotic carcinoma of rectum, 615  
 — sarcoma of rectum, 636
- Membranous œsophagitis, 42
- Mesenteric vessels, embolism and thrombosis of, 486
- Mesentery, extra length of, as a cause of volvulus, 389  
 — injury to, 306, 312, 316  
 — in intussusception, 372, 376  
 — involvement of, in sarcoma of small intestine, 415  
 — strangulation by, 357  
 — strangulation through rent in, 352, 444
- Meso-appendix, 490  
 — colon, 426  
 — — in volvulus, 449, 452  
 — rectum, 561  
 — — hydatid of, 676  
 — sigmoid, 427
- Meteorism, in acute obstruction from stricture, 400
- Meteorism, in internal strangulation, 360
- Micturition, difficulty of, in rectal prolapse, 640  
 — frequency of, in rectal irritation, 573, 578
- Mikulicz's operation in rectal prolapse, 646
- Misplacement of great intestine, 481
- Mucus, discharge of, in rectal polypus, 609
- Murphy's button, description of, 256  
 — in intestinal anastomosis, 401, 419
- 'Musculus pleuro-broncho œsophagus' as a cause of diverticula, 119
- Myomata of small intestine, 410  
 — causing pyloric obstruction, 210  
 — of œsophagus, 55  
 — of rectum, 606  
 — of stomach, 201
- Myxomata of œsophagus, 55  
 — of rectum, 607
- NÆVI of rectum, 608
- Naphthol in carcinoma of rectum, 631  
 — use of, before proctectomy, 680
- Needles, effects produced by wandering, 338
- Nélaton's operation of enterostomy, 522
- Nephritic colic simulating appendicitis, 503
- Nerve supply of great intestine, 429  
 — — of small intestine, 299  
 — — of œsophagus, 3  
 — — of rectum, 564  
 — — of stomach, 147
- Neuralgia of rectum, 672
- Neuroses, intestinal, 425  
 — rectal, 672
- Nomenclature of operations on intestines, 518
- Nose, affections of, as a cause of spasm of œsophagus, 107
- OBLITERATION, complete, of duodenum, 293
- Obstruction, cardiac, of stomach, 207  
 — duodenal, from malignant tumour, 290  
 — intestinal acute, from accumulation, fœcal, 458  
 — — from appendicitis, 500, 503  
 — — from carcinoma of great intestine, 468  
 — — — of rectum, 616, 617, 621, 634  
 — — from foreign body, intestinal, 330, 336  
 — — — rectal, 575

- Obstruction, intestinal acute, from  
 gall-stone, 401  
 — — after gastro-enterostomy, 259  
 — — from hernia, internal, 350  
 — — from intussusception, 371, 447  
 — — from peritonitis, 419  
 — — from pressure from without, 417  
 — — simulating appendicitis, 504  
 — — from stricture, cicatricial, 393,  
 438  
 — — — — rectal, 594  
 — — — — thrombosis of iliac vessels,  
 486  
 — — — — tumours, 410  
 — — — — volvulus, 389, 449  
 — — intestinal, chronic, as a cause of  
 ulceration, 436  
 — — — — rectal, from tumours, 609  
 — pyloric, of stomach, 208  
 Occlusion, membranous, of jejunum,  
 421  
 Œsophagectomy, operation of, 142  
 Œsophagismus, 106  
 Œsophagitis, acute traumatic, 37  
 — acute idiopathic, 38  
 — aphthous, 44  
 — catarrhal, 46  
 — of children, 40  
 — chronic, 44  
 — croupous, 46  
 — follicular, 42  
 — membranous or pellicular, 42  
 — phlegmonous, 46  
 Œsophagoplasty, operation of, 142  
 Œsophagoscope, 50, 69, 80  
 Œsophagoscopy, 28  
 Œsophagostomy, operation of, 140  
 — external, in stenosis, 99, 102  
 — internal, in carcinoma of œsophagus,  
 78, 81  
 — — — — in stenosis, 98, 102  
 Œsophagotome, 98, 136  
 Œsophagotomy, external, operation of  
 (cervical), 137  
 — — (thoracic), 139  
 — internal, operation of, 136  
 — — — — in removal of foreign bodies, 32,  
 34  
 Œsophagus, abnormalities of, 112  
 — anatomy, surgical, of, 1  
 — atresia, congenital, of, 126  
 — attachments of, 2  
 — calibre of, 3  
 — carcinoma of, 58  
 — course and extent of, 1  
 — cysts of, 55  
 — dilatation of, 112  
 — distortion of, 134  
 — diverticulum of, 117  
 — foreign bodies impacted in, 16  
 Œsophagus, injuries of, 4  
 — malformation of, 125  
 — operations on, 134  
 — paralysis of, 103  
 — perforation of, 133  
 — physiology of, 4  
 — pressure from without affecting,  
 131  
 — relations of, 2  
 — rupture of, 10  
 — sarcoma of, 84  
 — spasm of, 106  
 — stricture of, 84  
 — — — — malignant, 58  
 — structure of, 3  
 — syphilis of, 52  
 — torsion of, 130  
 — tuberculosis of, 52  
 — ulcer of, 46  
 — varix of, 49  
 — warts of, 54  
 Omentum, affections of, giving rise to  
 pyloric obstruction, 209  
 — gastro-hepatic, in relation to  
 stomach, 145  
 — great, 145  
 — strangulation, intestinal, by, 357  
 Opium, in carcinoma of rectum, 632  
 Ovarian tumours, causing intestinal  
 obstruction, 418  
 Ovariectomy, intestinal obstruction  
 after, 370  
 Ovary, adhesion of vermiform appen-  
 dix to, 444  
 PAIN in appendicitis, 498  
 — in carcinoma of intestine, great,  
 469, 471  
 — — — — of rectum, 616, 620  
 — — — — relief of, 632  
 — in duodenal ulcer, 278  
 — in injuries, rectal, 569, 573  
 — in intussusception, 380, 381  
 — in obstruction due to gall-stone, 403  
 — — — — pressure from without, 419  
 — in papilloma of rectum, 462  
 — in proctitis, 581  
 — in peritonitis, 420  
 — in proctitis, 578  
 — in prolapse, rectal, 640  
 — in rupture, traumatic (intestinal),  
 308  
 — in strangulation, internal, 359  
 — in stricture, cicatricial (intestinal),  
 395, 440  
 — — — — (rectal), 594  
 — — — — in thrombosis of mesenteric vessels,  
 486  
 — in ulcer, gastric, 178

- Pain in ulceration of rectum, 587  
 — in volvulus, 391, 451  
 — in wounds, 315  
 — — gunshot, 320  
 — after gastro-enterostomy, 258
- Pancreas, affections of, giving rise to pyloric obstruction, 209  
 — tumours of, pressing on duodenum, 289
- Panelectroscope in impacted foreign bodies of œsophagus, 24  
 — in rectal examination, 567
- Papillomata, intestinal, 462  
 — as a cause of intussusception, 447  
 — of œsophagus, 54  
 — of rectum, 603  
 — of stomach, 202
- Paralysis of œsophagus, 103  
 — — due to syphilis, 52  
 — — as a cause of dilatation, 113
- Parasacral method of proctectomy, 687
- Parietes, abdominal injury to, in wounds of abdomen, 314
- Parturition as a cause of stricture of rectum, 591  
 — — of ulceration of rectum, 586
- Pathology of appendicitis, 492  
 — of atresia of œsophagus, 126  
 — of carcinoma, intestinal, 465, 412  
 — — — rectal, 613  
 — of diverticula of œsophagus, 120  
 — of intussusception, 372
- Paul's operation of colectomy, 547
- Pellicular œsophagitis, 42
- Pelvis, laceration of rectum in fracture of, 666  
 — lack of development of, in atresia recti, 659
- Penis, rectum terminating in, 658, 661
- Perforation, duodenal, from external causes, 294  
 — — from malignant disease, 291  
 — — from ulcer, 280  
 — — from ulceration, 287  
 — — intestinal (great intestine) in appendicitis, 493, 502  
 — — — — treatment of, 515  
 — — — — from carcinoma, 467, 470, 617  
 — — — — from dilatation, 479  
 — — — — in thrombosis of mesenteric vessels, 487  
 — — — — from ulcer, 432, 435  
 — — — — intestinal (small intestine), from foreign body, 330  
 — — — — in intussusception, 391  
 — — — — several with no serious symptoms, 320  
 — — — — several successfully closed, 323, 327
- Perforation, intestinal (small intestine), in stricture, 398  
 — — — in typhoid, 342  
 — — — in ulceration, tubercular, 341  
 — — œsophageal, by foreign body, 20  
 — — — from external causes, 133  
 — — — from pressure of aneurysm, 131  
 — — — from ulceration of sarcoma, 83  
 — — — rectal, from foreign body, 575  
 — — — from carcinoma, 621  
 — — — from ulceration, 582  
 — — — of stomach, from foreign body, 167  
 — — — following lavage, 229  
 — — — in malignant disease, 203, 205  
 — — — of ulcer (subject), 181, 188, 190
- Pericarditis secondary to gastric ulcer, 192, 194
- Pericardium, distended, pressing on œsophagus, 131
- Perineal proctectomy, 681  
 — — prognosis of, 625
- Periproctitis, 580  
 — as a cause of stricture, 590  
 — in congenital rectal stricture, 670
- Peristalsis, violent, as a cause of volvulus, 450
- Peritonitis (intestine, great), in appendicitis, 502, 503  
 — — — — treatment of, 515  
 — — — — in carcinoma, 467  
 — — — — in stricture, cicatricial, 441  
 — — — — in ulcer, 432, 435, 437, 456  
 — — — — in volvulus, 450  
 — — — — (intestine small, duodenum), in duodenal perforation, 281, 290  
 — — — — in duodenal rupture, 274  
 — — — — (jejunum and ileum), from foreign body, 330  
 — — — — from gall-stone, 403  
 — — — — from intussusception, 381  
 — — — — from strangulation, internal, 360  
 — — — — from stricture, 399  
 — — — — from ulceration, traumatic, 303  
 — — — — — tubercular, 339  
 — — — — — typhoid, 341  
 — — — — — wounds, 316  
 — — — — — gunshot, 322  
 — — — — (rectal), from foreign body, 575  
 — — — — from stricture, 592, 594  
 — — — — (stomach), from perforated ulcer, 182  
 — — — — after gastro-enterostomy, 259, 264  
 — — — — symptoms of, 420  
 — — — — tubercular, giving rise to internal strangulation, 368
- Pessary in rectal prolapse, 641

- Petersen's bag, rupture of rectum by, 568
- Peyer's patches, 273, 299
- — in tubercular ulceration, 339
- — in typhoid ulceration, 341
- Phantom stricture of rectum, 672
- Pharyngeal diverticula, 118
- Phimosis as a cause of rectal prolapse, 638
- Phlebectasis of œsophagus, 49
- Phlebitis of iliac vein in appendicitis, 493
- Phlegmonous œsophagitis, 46
- Photography, new, in impacted foreign body of œsophagus, 21
- Physical examination of stomach, 153
- Physiognomy of internal strangulation, 360
- Physiology of great intestine, 430
- of small intestine, 300
- of œsophagus, 4
- of rectum, 564
- of stomach, 147
- Plates for intestinal anastomosis of
- Baracz (cabbage, turnip), 255
- of Dawbarn (potato), 255, 538
- of Robinson (raw hide), 257, 538
- of Senn (bone), 253, 535
- Plastic operation in congenital umbilical fistula, 424
- Pleurisy secondary to gastric ulcer, 192
- Pneumonia after gastro-enterostomy, 260
- secondary to gastric ulcer, 192
- Poisoning following lavage of stomach, 229
- irritant, effects of, as a cause of pyloric obstruction, 210, 214
- treated by aspiration of stomach, 230
- Polypi of great intestine, 462
- of small intestine, 410
- — as a cause of intussusception, 374
- — sarcomatous, 414
- of œsophagus, 55
- of rectum, 602, 609
- — as a cause of proctitis, 577
- — prolapse, 611, 638
- — ulceration, 581
- Pons, involvement of, in paralysis of œsophagus, 104
- Pouches of stomach, 202
- Probang in impacted foreign bodies of œsophagus, 31
- introduction of, 134
- Procidencia recti, 637
- Proctectomy, operation of, 680
- Proctectomy, perineal, 681
- sacral, 683
- vaginal, 691
- Proctitis, acute, 577
- chronic, 578
- — as a cause of stricture, 590
- Proctopexy, operation of, 693
- in rectal prolapse, 652
- Proctoplasty, operation of, 693
- Proctorrhaphy, operation of, 643, 692
- Proctotomy, external, operation of, 633, 679
- — in stricture, 600
- internal, 678
- — in stricture, 599
- Prolapse of bowel in sigmoid anus, 533
- of rectum, 637
- — causes, 638
- — symptoms, 639
- — treatment, 640
- Prolapsus ani, 637
- Prostate enlarged in rectal prolapse, 638
- Prostatic abscess pressing on rectum, 675
- Psoas muscle, involvement of, in appendicitis, 501
- Pulse in appendicitis, 499
- in rupture, traumatic, small intestine, 308
- in internal strangulation, 360
- in wounds, gunshot, 320
- Purgatives as a cause of proctitis, 577, 580
- — rectal ulceration, 581
- Pyæmia in appendicitis, 494, 501
- in carcinoma of great intestine, 468
- secondary to impacted fish-bone in œsophagus, 21
- Pylorectomy, operation of, 260
- references to, 215, 218, 220
- combined with gastro-enterostomy, 265
- Pyloroplasty, operation of, 265
- references to, 215, 222
- Pylorus, carcinoma of, 209
- curettage of (Bernay's), 268
- divulsion digital (Loreta's), 215, 222
- excision of (operation), 260
- — (reference), 220
- kink of, 209
- position of, 145
- stenosis of, 208
- — secondary to gastric ulcer, 200
- Pyo-pneumothorax, subphrenic, secondary to gastric ulcer, 194

- RECTAL alimentation, 693  
 — cauterisation, 643, 693  
 — electrolysis, 599, 693  
 Rectocele, 654  
 Rectopexy in rectal prolapse, 652  
 Rectostomia glutealis of Witzel in  
 proctectomy, 690  
 Rectum, adenomata of, 602  
 — anatomy of, 561  
 — angiomata of, 608  
 — atresia of, 665  
 — carcinomata of, 612  
 — concretions of, 573  
 — cystomata of, 607  
 — dermoids of, 603  
 — diverticula of, 670  
 — examination of, 566  
 — external influences on, 673  
 — fibromata of, 603  
 — fistulous communication between  
 appendix, 493  
 — foreign bodies of, 571  
 — hernia of, 654  
 — impaction of feces in, 572  
 — inflammation of, 577  
 — injuries of, 567  
 — intussusception of, 653  
 — lipomata of, 607  
 — lymphatics of, 564  
 — lymphomata, 606  
 — malformations of, 654  
 — myomata of, 606  
 — myxomata of, 607  
 — nævi of, 603  
 — nerve supply of, 564  
 — neuralgia of, 672  
 — neuroses of, 672  
 — operations on, 676  
 — papillomata of, 603  
 — physiology of, 564  
 — polypi of, 602  
 — — multiple, 605  
 — prolapse of, 637  
 — relations of, 562  
 — rupture of, 568  
 — sarcoma of, 636  
 — stricture, cicatricial, of, 590  
 — — congenital, 669  
 — — phantom, 672  
 — structure of, 562  
 — teratomata of, 608  
 — tumours of, 601  
 — ulceration of, 581  
 — vascular supply of, 563  
 — wounds of, 567, 569  
 Rehn's method of proctectomy,  
 686  
 Rehn-Rydygier method of proctectomy,  
 686  
 Relapsing appendicitis, 494, 502  
 Regurgitation of bowel contents into  
 stomach after gastro-enterostomy,  
 258  
 Rennie's peptonised meat in rectal  
 alimentation, 695  
 Resection of bowel in intussusception,  
 387, 389  
 — — in internal strangulation, 365  
 — of cardiac orifice of stomach (*see*  
*Excision*), 203  
 Respiration, embarrassment of, in fecal  
 accumulation, 456  
 — in traumatic rupture of small in-  
 testine, 308  
 Rheumatism in relation to appen-  
 dicitis, 497  
 — as a cause of stricture of œsophagus,  
 89  
 Ring stricture of great intestine, 466  
 Rings, catgut, in bowel union, 542  
 Roberts' operation in rectal prolapse,  
 644  
 Ruminants, condition in, as compared  
 with diverticula of œsophagus, 117  
 Rupture of cæcum, 617  
 — of duodenum, 173  
 — of intestine, great, 430, 442, 457  
 — — small, 305  
 — from inflation in intussusception,  
 384  
 — result of tapeworm, 339  
 — of œsophagus, 10  
 — of rectum, 640, 662  
 — of stomach, 157  
 — — following lavage, 229  
 SACRAL plexus, pressure on, in car-  
 cinoma of rectum, 616  
 — proctectomy, 683  
 — — prognosis of, 627  
 Sarcinæ ventriculi, causing pyloric  
 obstruction, 166  
 Sarcoma of duodenum, 289  
 — of great intestine, 476  
 — of small intestine, 414  
 — of œsophagus, 82  
 — of other organs pressing on œso-  
 phagus, 132  
 — of pylorus, 209  
 — of rectum, 636  
 — of stomach, 206  
 Sauropsida, condition of, and as found  
 in diverticula of œsophagus, 117  
 Scalds of œsophagus, 4  
 Scirrhus carcinoma of duodenum, 289  
 — carcinoma of intestine, 465  
 — — of œsophagus, 62  
 — — of rectum, 613, 615  
 — — of stomach, 203



- Scirrhus carcinoma of pylorus, 209  
 Scrotum, rectum opening into, 657, 658, 665  
 Senn's hydrogen gas test, 322  
 — operation of gastro-enterostomy, 252  
 — plates, preparation of, 253  
 — — bowel union by, 535  
 Septicæmia as a cause of acute duodenal ulceration, 284  
 Shock in traumatic rupture of small intestine, 307  
 — in wounds, intestinal, 315  
 — — gunshot, 319  
 Sigmoid anus, formation of, 550  
 — — in rectal ulceration, 589  
 Sigmoidectomy, operation of, 546  
 Sigmoid flexure, accumulation, fecal, in, 455  
 — anatomy of, 427  
 — diverticula of, 483, 484  
 — length of, in volvulus, 450  
 — misplacement of, 482  
 — rupture of, 457  
 — ulcer of, 433  
 Sigmoidostomy, operation of, 544, 546  
 Sigmoidotomy in removal of rectal foreign body, 576  
 Silver nitrate in rectal prolapse, 641  
 Site, usual, of gastric ulcer, 178  
 Sloughing of small intestine in contusion, 302  
 Small-pox, as a cause of stenosis of œsophagus, 85  
 Smith's (Greig) method of fixing stomach in gastrostomy, 235  
 Solvents, use of, in impacted foreign body of œsophagus, 31  
 Spasm of œsophagus, 106  
 — of stomach, cardiac orifice causing dilatation of œsophagus, 112  
 — — as a cause of pyloric obstruction, 210  
 Spinal cord, injury to, from impacted fish bone in œsophagus, 23  
 Spongy carcinoma of duodenum, 289  
 Spur, formation of, in colectomy, 548  
 — removal of, in colectomy, 555  
 Stenosis (*see under* Stricture)  
 Stercoral ulcer of great intestine, 437, 456  
 Sternum, blow on, as a cause of dilatation of œsophagus, 113  
 Stings, insect, as a cause of œsophagitis, 37  
 Stomach affections as a cause of spasm of œsophagus, 107  
 — anatomy, surgical, of, 145  
 — aspiration of, 229  
 — carcinoma of, 202  
 Stomach, cardiac orifice, obstruction of, 207  
 — contusions of, 156  
 — dilatation of, 224  
 — — — in pyloric obstruction, 213  
 — fistulous communication between colon and, 467  
 — foreign bodies in, 164  
 — gastric juice (*see* Gastric juice)  
 — lavage of, 228  
 — motor power of, method of determining, 152  
 — operations on, 228  
 — physical examination of, 153  
 — physiology of, 147  
 — pylorus (*see* Pylorus)  
 — rupture of, 157  
 — sarcoma of, 206  
 — stenosis of (*see* Stenosis)  
 — structure of, 146  
 — symptoms in carcinoma of œsophagus, 61, 65, 71  
 — tumours of, 201, 224  
 — ulcer of, 176  
 — wounds penetrating, 161  
 Strangulation, internal, of small intestine (*see* Hernia, internal), 350  
 Stricture, cicatricial, of *duodenum*, 291  
 — congenital, of *duodenum*, 293  
 — cicatricial, of *great intestine*, 438  
 — — — as a cause of intussusception, 447  
 — — — due to ulcer, dysenteric, 435  
 — — — stercoral, 437  
 — — — tubercular, 434  
 — — of *small intestine*, 393  
 — — — causes of, 301, 337, 340, 393, 413  
 — — — symptoms of, 398  
 — — — treatment of, 400  
 — congenital, of small intestine, 397, 421  
 — — cicatricial, of *œsophagus*, 84  
 — — — as a cause of dilatation, 112  
 — — — of diverticula, 117  
 — — — differential diagnosis of, 69  
 — — — dilatation of, by laminaria, 78  
 — — — symptoms of, 122  
 — congenital, of *œsophagus*, 128  
 — — — symptoms of, 115  
 — — malignant, of *œsophagus*, 58  
 — — cicatricial, of *rectum*, 590  
 — — as a cause of proctitis, 557  
 — — as a cause of ulceration, 581  
 — — from pelvic cellulitis, 674  
 — — from proctitis, chronic, 578  
 — — from ulceration, 584  
 — congenital, of *rectum*, 669  
 — phantom, of *rectum*, 672  
 — ring, of *rectum*, 614, 616, 617

- Stricture, ring, division of, 632  
 — of *stomach*, cardiac orifice, 207  
 — — pyloric orifice, 208  
 — — — congenital, 210  
 — — — due to ulcer, 200  
 — of *urethra* as a cause of rectal pro-  
 lapse, 638  
 Structure of great intestine, 427  
 — small intestine, 297  
 — œsophagus, 3  
 — rectum, 562  
 — stomach, 146  
 Subdiaphragmatic abscess secondary  
 to gastric ulcer, 193, 195  
 Succussion in dilatation of stomach,  
 214, 225  
 Suppuration of malignant tumour,  
 great intestine, 467, 470  
 Surgical anatomy of great intestine,  
 425  
 — — of small intestine, 297  
 — — of œsophagus, 1  
 — — of rectum, 564  
 — — of stomach, 145  
 Suture of perforated gastric ulcer, 185  
 — union of bowel by, 528  
 — — Abbe's, 531  
 — — Bishop's, 530  
 — — Czerny-Lembert, 529  
 — — Halsted's, 535  
 — — Maunsell's, 532  
 — — Wölfler's, 529  
 Syphilis of œsophagus, 52  
 — as a cause of stricture of œsophagus,  
 81  
 — — of intestinal stricture, 394  
 — — of rectal stricture, 591  
 Syphilitic ulceration of great intestine,  
 437  
 — — of rectum, 584

#### TABLES, *intestinal* :

- Table of fifty cases carcinoma, 465  
 — of successful cases of operation  
 in intussusception, 385  
 — — in obstruction due to gall-  
 stone, 408  
 — — in internal strangulation, 362  
 — — in volvulus, 392

#### — *oesophageal* :

- Weinlechner's table of site of stric-  
 ture, 86

#### — *rectal* :

- Table of operations in atresia recti,  
 Ander's, 662  
 — — Cripps', 662  
 — — Curling's, 663  
 — — in carcinoma by perineal  
 method, Cripps', 625

#### Tables, *rectal* :

- Table of operations in carcinoma by  
 perineal method, Czerny's, 626  
 — — Lövingsohn's, 626  
 — *stomach* :  
 Table of cases of gastric ulcer  
 successfully operated upon, 188  
 Tape-worm, causing rupture of bowel,  
 339  
 Taxis, abdominal, in intussusception,  
 383  
 — — in obstruction due to gall-stone,  
 405  
 — — in volvulus, 391  
 Teeth, affections of, as a cause of  
 spasm of œsophagus, 107  
 Temperature in appendicitis, 499  
 — in peritonitis, 420  
 — in rupture, traumatic, small intes-  
 tine, 308  
 — in strangulation, internal, 360  
 — in thrombosis, mesenteric vessels,  
 486  
 — in wounds, gunshot, intestinal, 320  
 Tenesmus in foreign bodies of rectum,  
 573  
 — in intussusception, 379, 448  
 — in proctitis, 578  
 — in prolapse, rectal, 640  
 — in stricture, great intestine, 440  
 — in ulceration, rectal, 586  
 Tents, laminaria, in stenosis of œso-  
 phagus, 78, 97  
 Teratomata of rectum, 608  
 Tetany subsequent to lavage of  
 stomach, 228  
 Thoracic œsophagotomy, 139  
 Thrombotic appendicitis, 494  
 Tonsil in appendicitis, 497  
 Tonsils, affections of, in spasm of œso-  
 phagus, 107  
 Tooth plate, impaction of, in œso-  
 phagus, 25  
 — removal of, by gastrotomy, 32,  
 36  
 Torsion of œsophagus, 130  
 Traction in diverticula of œsophagus,  
 119  
 Transfusion in excessive hæmorrhage  
 from gastric ulcer, 180  
 — in duodenal ulcer, 282  
 Translumination of stomach, 155  
 Transposition of viscera (bowel), 481,  
 422  
 Trendelenburg, position in appen-  
 dicectomy, 557  
 Treves' operation in rectal prolapse,  
 647  
 Trocar and canula in rectal atresia,  
 668

- Tubage, permanent, of Gersuny in carcinoma of œsophagus, 77  
 Tubercular appendicitis, 494  
 — ulcer, intestinal, 339, 434  
 — ulceration, rectum, 583  
 Tuberculosis of œsophagus, 52  
 — as a cause of stenosis, 88  
 — as a cause of stenosis of rectum, 591  
 Tubes, bone, in bowel union, 537  
 — Paul's method, 538  
 — india-rubber, Robinson's, 539  
 — retained, in carcinoma of œsophagus, 74, 77, 79, 81  
 Tumours of duodenum, 288  
 — of great intestine, 461  
 — of small intestine, 410  
 — of œsophagus, 54  
 — of rectum, 601  
 — of stomach, 201  
 Tympanites in carcinoma (intestinal), 470  
 — perforation (intestinal), 315  
 — thrombosis of mesenteric vessels, 486  
 — volvulus, 451  
 — wounds, gunshot, 320  
 Typhlitis, 431  
 Typhoid fever simulating appendicitis, 504  
 — ulceration, 341, 433
- ULCER** of *duodenum*, 277  
 — — complications of, 280  
 — — excision of, 282  
 — — fistula from, 281  
 — — hæmorrhage from, 279  
 — — perforation of, 280  
 — — prognosis of, 279  
 — — symptoms of, 278  
 — — treatment of, 282  
 — of *great intestine*, catarrhal, 437  
 — — dysenteric, 435  
 — — simple, 431  
 — — stercoral, 437, 456  
 — — syphilitic, 437  
 — — tubercular, 434  
 — — typhoid, 433  
 — of *œsophagus*, 46  
 — — as a cause of stenosis, 87  
 — of *stomach*, 176  
 — — abscess from, 192  
 — — adhesions in, 198  
 — — character of, 177  
 — — contractions, internal, in, 199  
 — — diagnosis from varix of œsophagus, 50  
 — — excision of, 179  
 — — fistulæ secondary to, 196
- Ulcer of *stomach*, hæmorrhage in, 180  
 — — perforation of, 181  
 — — situation of, 176  
 — — stenosis, pyloric, from, 200, 210  
 — — symptoms of, 176  
 — — treatment of, 185  
 Ulceration of *duodenum*, acute, 284  
 — — relation of burns to, 284  
 — — — of septicæmia to, 285  
 — — symptoms of, 287  
 — — of tumour, malignant, 290  
 — of *great intestine*, 431  
 — — of appendix, 493  
 — — in carcinoma, 466  
 — — in rectal carcinoma, 617  
 — — in spinal cord lesions, 437  
 — — tubercular, in appendicitis, 496  
 — — typhoid in appendicitis, 496  
 — of *small intestine* from contusion, 302  
 — — from foreign body, 330  
 — — from gall-stone, 403  
 — — from tumours, malignant, 413  
 — — from tubercular, 339, 393  
 — — from typhoid, 341, 393  
 — of *œsophagus*, 20  
 — of *rectum*, 581  
 — — in diarrhœa, chronic, 581  
 — — in diphtheria, 381  
 — — dysentery, 581  
 — — foreign body, 581, 575, 634  
 — — gonorrhœa, 581  
 — — impaction, fœcal, 581  
 — — in inflammation of Bartholin's gland, 586  
 — — in injury, 581  
 — — in parturition, 586  
 — — in polypus, 581  
 — — in proctitis, 579  
 — — in tuberculosis, 583  
 — — in syphilis, 584  
 — — varicose, 581, 595  
 — — symptoms of, 586  
 — — treatment of, 586  
 — — as a cause of proctitis, 580  
 — — as a cause of stricture, 590  
 — — as a sequence of stricture, 592, 670  
 Uretero-enterostomy, operation of, 560  
 Urethra, fistulous, communication between colon and, 484  
 — — between rectum and, 575, 592, 617  
 — — rectum opening into (congenital), 657, 660, 663, 665  
 Urethrotome, Maisonneuve's, in stenosis of œsophagus, 101  
 Urine, state of, in internal strangulation, 360

- Urine, state of, in traumatic rupture, intestinal, 309  
 — retention of in rectal prolapse, 640  
 — suppression of, after gastro-enterostomy, 258
- Uterine intra-inflammation as a cause of intestinal misplacement, 481  
 — tumours causing obstruction, intestinal, 418  
 — — rectal, 674
- Uterus, affections of, in spasm of œsophagus, 107  
 — fistulous, communication between rectum and, 575, 592, 617, 634  
 — rectum, opening into (congenital), 658
- VAGINA, fistulous communication between rectum and, 575, 592, 617, 634  
 — rectum opening into (congenital), 657, 661, 665
- Vaginal proctectomy, 691
- Vagus, involvement of, in dilatation of œsophagus, 113  
 — in paralysis of œsophagus, 103  
 — in spasm of œsophagus, 106
- Valve, ileo-cæcal, anatomy of, 429
- Valvulæ conniventes of duodenum, 272  
 — ileum, 298  
 — jejunum, 298  
 — mal-development of, in congenital stricture, 397, 422
- Valvular opening in sigmoid anus, formation of, 553
- Varicose ulcer of rectum, 585, 591
- Varix of œsophagus, 49
- Vascular supply of great intestine, 428  
 — — of small intestine, 299  
 — — of œsophagus, 3  
 — — of rectum, 563  
 — — of stomach, 147
- Vermiform appendix (*see* Appendix)
- Verneuil's operation in rectal prolapse, 649
- Villi of duodenum, 272  
 — of ileum, 298  
 — of jejunum, 298
- Villous carcinoma of great intestine, 466  
 — tumour of rectum, 603
- Vitelline duct, malformations of, 420
- Volvulus of great intestine, 449  
 — of small intestine, 389
- Vomiting in appendicitis, 499  
 — in carcinoma, intestinal, 290, 469, 471  
 — — rectal, 621  
 — in gall-stone obstruction, 403  
 — in gastric ulcer, relation to site, 178  
 — in intussusception, 380, 448  
 — in peritonitis, 420  
 — in pyloric obstruction, 212  
 — in rupture, traumatic, intestinal, 274, 308  
 — — stomach, 159  
 — in strangulation, internal, 359, 364, 366  
 — in stricture, intestinal, 398, 440  
 — in volvulus, 391, 451  
 — persistent, after gastro-enterostomy, 258
- WARTS of œsophagus, 54
- Weinlechner's table of site of stricture of œsophagus, 86
- Whooping-cough as a cause of rectal prolapse, 638
- Witzel's operation of gastrostomy, 242
- Wölfler's gastro-enterostomy, 249  
 — suture in bowel union, 529
- Worms, intestinal, as a cause of proctitis, 577  
 — — — prolapse, rectal, 638  
 — — — spasm of œsophagus, 107
- Wounds of intestine, 313  
 — of œsophagus, 7  
 — of rectum, 569  
 — of stomach, 161, 163  
 — operation, giving rise to internal strangulation, 368

## A SELECTION

FROM

## J. &amp; A. CHURCHILL'S CATALOGUE,

COMPRISING

MOST OF THE RECENT WORKS PUBLISHED BY THEM.

*N.B.—J. & A. Churchill's larger Catalogue, which contains over 600 works, with a Complete Index to their Subjects, will be sent on application.*

**Human Anatomy :**

A Treatise by various Authors. Edited by HENRY MORRIS, M.A., M.B. Lond., F.R.C.S., Surgeon to, and Lecturer on Surgery at, the Middlesex Hospital. Roy. 8vo, with 791 Illustrations, nearly all original, and many of them in several colours, 40s. (In one vol. or in three parts.)

**Heath's Practical Anatomy :**

A Manual of Dissections. Eighth Edition. Edited by WILLIAM ANDERSON, F.R.C.S., Surgeon and Lecturer on Anatomy at St. Thomas's Hospital, Examiner in Anatomy for R.C.P. and S. Crown 8vo, with 329 Engravings, 15s.

**Wilson's Anatomist's Vade-**

**Mecum.** Eleventh Edition. By HENRY E. CLARK, M.R.C.S. Eng., F.F.P.S. Glasg., Examiner in Anatomy, F.P.S., and Professor of Surgery in St. Mungo's College, Glasgow. Crown 8vo, with 492 Engravings and 26 Coloured Plates, 18s.

**An Atlas of Human Anatomy.**

By RICKMAN J. GODLEE, M.S., F.R.C.S., Surgeon and late Demonstrator of Anatomy, University College Hospital. With 48 Imp. 4to Plates (112 figures), and a volume of Explanatory Text. 8vo, £4 14s. 6d.

**Human Osteology.**

By LUTHER HOLDEN, Consulting Surgeon to St. Bartholomew's Hospital. Seventh Edition, edited by CHARLES STEWART, F.R.S., Conservator of the Museum R.C.S., and ROBERT W. REID, M.D., F.R.C.S., Professor of Anatomy in the University of Aberdeen. 8vo, with 59 Lithographic Plates and 75 Engravings. 16s.

*Also.***Landmarks, Medical and Surgical.** Fourth Edition. 8vo, 3s. 6d.**The Student's Guide to Surgical**

**Anatomy.** By EDWARD BELLAMY, F.R.C.S. and Member of the Board of Examiners. Third Edition. Fcap. 8vo, with 81 Engravings. 7s. 6d.

**Diagrams of the Nerves of the**

**Human Body,** exhibiting their Origin, Divisions, and Connections, with their Distribution to the Various Regions of the Cutaneous Surface, and to all the Muscles. By Sir W. H. FLOWER, K.C.B., F.R.S., F.R.C.S. Third Edition, with 6 Plates. Royal 4to, 12s.

**Pathological Anatomy of Dis-**

**eases.** Arranged according to the nomenclature of the R.C.P. Lond. (Student's Guide Series). By NORMAN MOORE, M.D., F.R.C.P., Assistant Physician and Lecturer on Pathological Anatomy to St. Bartholomew's Hospital. Fcap. 8vo, with 111 Engravings, 8s. 6d.

**A Manual of Clinical and Prac-**

**tical Pathology.** By W. E. WYNTER, M.D., M.R.C.P., F.R.C.S., Medical Registrar to Middlesex Hospital, and F. J. WETHERED, M.D., M.R.C.P., Assistant Physician to Victoria Park Hospital. With 4 Coloured Plates and 67 Engravings. 8vo, 12s. 6d.

**Lectures on Pathology :**

Delivered at the London Hospital. By the late HENRY GAWEN SUTTON, M.B., F.R.C.P., Physician to, and Lecturer on Pathology at, the London Hospital. Edited by MAURICE E. PAUL, M.D., and Revised by SAMUEL WILKS, M.D., LL.D., F.R.S. 8vo, 15s.

**General Pathology :**

An Introduction to. By JOHN BLAND SUTTON, F.R.C.S., Sir E. Wilson Lecturer on Pathology, R.C.S.; Assistant Surgeon to, and Lecturer on Anatomy at, Middlesex Hospital. 8vo, with 149 Engravings, 14s.

**Atlas of Pathological Anatomy.**

By Dr. LANCEREAUX. Translated by W. S. GREENFIELD, M.D., Professor of Pathology in the University of Edinburgh. Imp. 8vo, with 70 Coloured Plates, £5 5s.

**Index Pathologicus, for the Registration of the Lesions recorded in Pathological Records or Case-books of Hospitals and Asylums.** By JAMES C. HOWDEN, M.D., Superintendent of the Royal Lunatic Asylum, Montrose. Fcap. folio, 6s.

**Atlas of the Central Nervous System.** From the larger work of Hirschfeld and Léveillé. Edited by HOWARD H. TOOTH, M.D., F.R.C.P., Assistant Physician to the National Hospital for the Paralysed and Epileptic. With 37 Plates carefully coloured by Hand. Large Imp. 8vo, 40s.

**The Human Brain :**

Histological and Coarse Methods of Research. A Manual for Students and Asylum Medical Officers. By W. BEVAN LEWIS, L.R.C.P. Lond., Medical Superintendent, West Riding Lunatic Asylum. 8vo, with Wood Engravings and Photographs, 8s.

**The Physiology and the Pathology of the Cerebral Circulation : an Experimental Research.** By LEONARD HILL, M.B., Hunterian Professor, R.C.S. With 41 Illustrations, Royal 8vo, 12s.

**Elements of Human Physiology.**

By ERNEST H. STARLING, M.D., M.R.C.P., Joint Lecturer on Physiology at Guy's Hospital. Second Edition. Crown 8vo, with 126 Engravings, 7s. 6d.

**Manual of Physiology :**

For the use of Junior Students of Medicine. By GERALD F. YEO, M.D., F.R.S., Emeritus Professor of Physiology in King's College, London. Third Edition. Crown 8vo, with 254 Engravings (many figures), and Plate of Spectra, 14s.

**Principles of Human Physiology.** By W. B. CARPENTER, C.B., M.D., F.R.S. Ninth Edition. By HENRY POWER, M.B., F.R.C.S. 8vo, with 3 Steel Plates and 377 Wood Engravings, 31s. 6d.

**Practical Lessons in Elementary Biology, for Junior Students.** By PEYTON T. B. BEALE, F.R.C.S., Lecturer on Elementary Biology and Demonstrator in Physiology in King's College, London. Crown 8vo, 3s. 6d.

**Medical Jurisprudence :**

Its Principles and Practice. By ALFRED S. TAYLOR, M.D., F.R.C.P., F.R.S. Fourth Edition, by THOMAS STEVENSON, M.D., F.R.C.P., Lecturer on Medical Jurisprudence at Guy's Hospital. 2 vols. 8vo, with 189 Engravings, 31s. 6d.

*By the same Authors.*

**A Manual of Medical Jurisprudence.** Twelfth Edition. Crown 8vo, with 55 Engravings, 14s.

**Hygiene and Public Health.**

A Treatise by various Authors. Edited by THOMAS STEVENSON, M.D., F.R.C.P., Lecturer on Chemistry and Medical Jurisprudence at Guy's Hospital; Official Analyst to the Home Office; and SHIRLEY F. MURPHY, Medical Officer of Health of the County of London. In 3 vols., royal 8vo, fully illustrated. Vol. I., 28s.; Vol. II., 32s.; Vol. III., 20s.

**The Theory and Practice of**

**Hygiene.** By J. LANE NOTTER, M.D., Examiner in Hygiene and Public Health in the University of Cambridge and in the Victoria University, Professor of Hygiene in the Army Medical School; and R. H. FIRTH, F.R.C.S., Assistant Professor of Hygiene in the Army Medical School. With numerous Illustrations, Royal 8vo, 24s.

**A Manual of Practical Hygiene.**

By the late E. A. PARKES, M.D., F.R.S. Eighth Edition, by J. LANE NOTTER, A.M., M.D. 8vo, with 10 Plates and 103 Engravings, 18s.

**A Handbook of Hygiene and**

**Sanitary Science.** By GEO. WILSON, M.A., M.D., LL.D., F.R.S.E., D.P.H. Camb., Medical Officer of Health for Mid-Warwickshire. Seventh Edition. Crown 8vo, with Engravings, 12s. 6d.

**Elements of Health : an Introduction to the Study of Hygiene.**

By LOUIS C. PARKES, M.D., D.P.H. Lond., Lecturer on Public Health at St. George's Hospital. Post 8vo, with 27 Engravings, 3s. 6d.

**The Prevention of Epidemics**

**and the Construction and Management of Isolation Hospitals.** By ROGER MCNEILL, M.D. Edin., D.P.H. Camb., Medical Officer of Health for the County of Argyll. 8vo. With several Hospital Plans, 10s. 6d.

**Hospitals and Asylums of the**

**World; their Origin, History, Construction, Administration, Management, and Legislation.** By HENRY C. BURDET. In 4 vols. Super Royal 8vo and Portfolio. Complete, 168s. Vols. I. and II.—Asylums: 90s. Vols. III. and IV.—Hospitals, &c., with Portfolio of Plans, 120s.

**Mental Diseases :**

Clinical Lectures. By T. S. CLOUSTON, M.D., F.R.C.P. Edin., Lecturer on Mental Diseases in the University of Edinburgh. Fourth Edition. Crown 8vo, with 15 Plates, 14s.

**Mental Physiology, especially in its Relation to Mental Disorders.** By THEO. B. HYSLOP, M.D., Assistant Physician, Bethlem Royal Hospital; Lecturer on Mental Diseases, St. Mary's Hospital Medical School. 8vo, 18s.

**The Insane and the Law: a Plain Guide for Medical Men, Solicitors, and Others** as to the Detention and Treatment, Maintenance, Responsibility, and Capacity either to give evidence or make a will of Persons Mentally Afflicted. With Hints to Medical Witnesses and to Cross-Examining Counsel. By G. PITT-LEWIS, Q.C., R. PERCY SMITH, M.D., F.R.C.P., Resident Physician, Bethlem Hospital, and J. A. HAWKE, B.A., Barrister-at-Law. 8vo, 14s.

**Illustrations of the Influence of the Mind upon the Body in Health and Disease:** Designed to elucidate the Action of the Imagination. By D. HACK TUKE, M.D., F.R.C.P., LL.D. Second Edition. 2 vols. crown 8vo, 15s.

**A Dictionary of Psychological Medicine,** giving the Definition, Etymology, and Synonyms of the Terms used in Medical Psychology; with the Symptoms, Treatment, and Pathology of Insanity; and **THE LAW OF LUNACY IN GREAT BRITAIN AND IRELAND.** Edited by D. HACK TUKE, M.D., LL.D., assisted by nearly 130 Contributors, British, Continental and American. 2 vols., 1,500 pages, royal 8vo, Illustrated. 42s.

**Lunacy Law for Medical Men.** By CHARLES MERCIER, M.B., Lecturer on Neurology and Insanity to the Westminster Hospital Medical School, and to the Medical School for Women. Crown 8vo, 5s.

**The Journal of Mental Science.** Published Quarterly, by Authority of the Medico-Psychological Association. 8vo, 5s.

**Mental Affections of Childhood and Youth** (Lettsomian Lectures for 1887, &c.). By J. LANGDON-DOWN, M.D., F.R.C.P., Consulting Physician to the London Hospital. 8vo, 6s.

**Manual of Midwifery:** Including all that is likely to be required by Students and Practitioners. By ALFRED L. GALABIN, M.A., M.D., F.R.C.P., Obstetric Physician to, and Lecturer on, Midwifery, &c., at Guy's Hospital. Third Edition. Crown 8vo, with 261 Engravings, 15s.

**Sterility.** By ROBERT BELL, M.D., F.F.P. & S., Senior Physician to the Glasgow Hospital for Diseases peculiar to Women. 8vo, 5s.

**The Student's Guide to the Practice of Midwifery.** By D. LLOYD ROBERTS, M.D., F.R.C.P., Lecturer on Clinical Midwifery and Diseases of Women at the Owens College; Obstetric Physician to the Manchester Royal Infirmary. Fourth Edition. Fcap. 8vo, with Coloured Plates and Engravings.

[Preparing.]

**Manual of the Diseases peculiar to Women.** By JAMES OLIVER, M.D., F.R.S. Edin., M.R.C.P. Lond., Physician to the Hospital for Diseases of Women, London. Fcap. 8vo, 3s. 6d.

*By the same Author.*

**Abdominal Tumours and Abdominal Dropsy in Women.** Crown 8vo, 7s. 6d.

**Obstetric Aphorisms:** For the Use of Students commencing Midwifery Practice. By JOSEPH G. SWAYNE, M.D. Tenth Edition. Fcap. 8vo, with 20 Engravings, 3s. 6d.

**Lectures on Obstetric Operations:** Including the Treatment of Hæmorrhage, and forming a Guide to the Management of Difficult Labour. By ROBERT BARNES, M.D., F.R.C.P., Consulting Obstetric Physician to St. George's Hospital. Fourth Edition. 8vo, with 121 Engravings, 12s. 6d.

*By the same Author.*

**A Clinical History of Medical and Surgical Diseases of Women.** Second Edition. 8vo, with 181 Engravings, 28s.

**Clinical Lectures on Diseases of Women:** Delivered in St. Bartholomew's Hospital, by J. MATTHEWS DUNCAN, M.D., LL.D., F.R.C.P., F.R.Ss. L. & E., late Obstetric Physician to St. Bartholomew's Hospital. Fourth Edition. 8vo, 16s.

**Gynæcological Operations:** (Handbook of). By ALBAN H. G. DORAN, F.R.C.S., Surgeon to the Samaritan Hospital. 8vo, with 167 Engravings, 15s.

**The Student's Guide to the Diseases of Women.** By ALFRED L. GALABIN, M.A., M.D., F.R.C.P., Obstetric Physician to Guy's Hospital. Fifth Edition. Fcap. 8vo, with 142 Engravings, 8s. 6d.

**A Practical Treatise on the Diseases of Women.** By T. GAILLARD THOMAS, M.D. Sixth Edition, by PAUL F. MUNDÉ, M.D., Professor of Gynæcology at the New York Polyclinic and at Dartmouth College. Roy. 8vo, with 347 Engravings, 25s.

**Notes on Diseases of Women:** Specially designed to assist the Student in preparing for Examination. By JAMES J. REYNOLDS, L.R.C.P., M.K.C.S. Fourth Edition, Fcap. 8vo., 3s. 6d.

**Abdominal Surgery.**

By J. GREIG SMITH, M.A., F.R.S.E., Surgeon to the Bristol Royal Infirmary, Professor of Surgery, University College, Bristol. Fifth Edition. Two Vols., 8vo, with 224 Engravings, 36s.

**The Physiology of Death from Traumatic Fever; A Study in Abdominal Surgery.**

By JOHN D. MALCOLM, M.B., C.M., F.R.C.S.E., Surgeon to the Samaritan Free Hospital. 8vo, 3s. 6d.

**Notes on Gynæcological Nursing.**

By JOHN BENJAMIN HELLIER, M.D., M.R.C.S., Lecturer on the Diseases of Women and Children in the Yorkshire College, and Surgeon to the Hospital for Women, &c., Leeds. Cr. 8vo, 1s. 6d.

**A Manual for Hospital Nurses**

and others engaged in Attending on the Sick, with a Glossary. By EDWARD J. DOMVILLE, Surgeon to the Devon and Exeter Hospital. Eighth Edition. Crown 8vo, 2s. 6d.

**A Manual of Nursing, Medical and Surgical.**

By CHARLES J. CULLINGWORTH, M.D., F.R.C.P., Obstetric Physician to St. Thomas's Hospital. Third Edition. Fcap. 8vo, with Engravings, 2s. 6d.

*By the same Author.*

**A Short Manual for Monthly Nurses.**

Fourth Edition. Fcap. 8vo, 1s. 6d.

**Diseases of Children.**

For Practitioners and Students. By W. H. DAY, M.D., Physician to the Samaritan Hospital. Second Edition. Crown 8vo, 12s. 6d.

**The Diseases of Children.**

By JAS. F. GOODHART, M.D., F.R.C.P., Physician to Guy's Hospital. Fifth Edition. Fcap. 8vo, 10s. 6d.

**A Practical Treatise on Disease in Children.**

By EUSTACE SMITH, M.D., F.R.C.P., Physician to the King of the Belgians, and to the East London Hospital for Children, &c. Second Edition. 8vo, 22s.

*By the same Author.*

**Clinical Studies of Disease in Children.**

Second Edition. Post 8vo, 7s. 6d.

*Also.*

**The Wasting Diseases of Infants and Children.**

Fifth Edition. Post 8vo, 8s. 6d.

**A Practical Manual of the Diseases of Children.**

With a Formulary. By EDWARD ELLIS, M.D. Fifth Edition. Crown 8vo, 10s.

**Materia Medica :**

A Manual for the use of Students. By ISAMBARD OWEN, M.D., F.R.C.P., Lecturer on Materia Medica, &c., to St. George's Hospital. Second Edition. Crown 8vo, 6s. 6d.

**Materia Medica,**

Pharmacy, Pharmacology, and Therapeutics. By W. HALE WHITE, M.D., F.R.C.P., Physician to, and Lecturer on Materia Medica and Therapeutics at, Guy's Hospital; Examiner in Materia Medica on the Conjoint Board of the Royal Colleges of Physicians and Surgeons. Fcap. 8vo, 7s. 6d.

**Materia Medica**

And Therapeutics. By CHARLES D. F. PHILLIPS, M.D., F.R.S. Edin.

Vegetable Kingdom—Organic Compounds—Animal Kingdom. 8vo, 25s. Inorganic Substances. Second Edition. 8vo, 21s.

**Recent Materia Medica.**

Notes on their Origin and Therapeutics. By F. HARWOOD LESCHER, F.C.S., Pereira Medallist. Fourth Edition. 8vo, 2s. 6d.

**Galenic Pharmacy :**

A Practical Handbook to the Processes of the British Pharmacopœia. By R. A. CRIPPS, M.P.S. 8vo, with 76 Engravings, 8s. 6d.

**The Galenical Preparations of the British Pharmacopœia :**

A Handbook for Medical and Pharmaceutical Students. By CHARLES O. HAWTHORNE, M.B., C.M., Lecturer on Materia Medica and Therapeutics, Queen Margaret College, University of Glasgow. 8vo, 4s. 6d.

**Practical Pharmacy.**

By BARNARD S. PROCTOR, formerly Lecturer on Pharmacy at the College of Medicine, Newcastle-on-Tyne. Third Edition. 8vo, with 44 Wood Engravings and 32 Lithograph Fac-Simile Prescriptions, 14s.

**Selecta à Prescriptis :**

Containing Terms, Phrases, Contractions and Abbreviations used in Prescriptions, with Explanatory Notes, &c. Also, a Series of Abbreviated Prescriptions with Translations and Key. By J. PEREIRA, M.D., F.R.S. Eighteenth Edition, by JOSEPH INCE, F.C.S., F.L.S. 24mo, 5s.

**A Companion to the British Pharmacopœia.**

By PETER SQUIRE, Revised by his Sons, P. W. and A. H. SQUIRE. Sixteenth Edition. 8vo, 12s. 6d.

*By the same Authors.*

**The Pharmacopœias of the London Hospitals,**

arranged in Groups for Easy Reference and Comparison. Sixth Edition. 18mo. 6s.



**Pocket Formulary**

And Synopsis of the British and Foreign Pharmacopœias. By HENRY BEASLEY. Eleventh Edition. 18mo, 6s. 6d.

*By the same Author.*

**Druggist's General Receipt-Book.** Tenth Edition. 18mo, 6s. 6d.

*Also.*

**Book of Prescriptions :**

Containing upwards of 3,000 Prescriptions from the Practice of the most eminent Physicians and Surgeons, English and Foreign. Seventh Edition. 18mo, 6s. 6d.

**The Prescriber's Pharmacopœia:**

The Medicines arranged in Classes according to their Action, with their Composition and Doses. By NESTOR J. C. TIRARD, M.D., F.R.C.P., Professor of Materia Medica and Therapeutics in King's College, London. Sixth Edition. 32mo, bound in leather, 3s.

**Year-Book of Pharmacy :**

Containing the Transactions of the British Pharmaceutical Conference. Annually. 8vo, 10s.

**Royle's Manual of Materia**

Medica and Therapeutics. Sixth Edition, including additions and alterations in the B.P. 1885. By JOHN HARLEY, M.D., Physician to St. Thomas's Hospital. Crown 8vo, with 139 Engravings, 15s.

**Southall's Organic Materia**

Medica: a Handbook treating of some of the more important of the Animal and Vegetable Drugs made use of in Medicine, including the whole of those contained in the B.P. Fifth and Enlarged Edition. By JOHN BARCLAY, B.Sc.Lond., some time Lecturer on Materia Medica and Pharmacy in Mason College, Birmingham. 8vo, 6s.

**Manual of Botany.**

By J. REYNOLDS GREEN, Sc.D., M.A., F.R.S., Professor of Botany to the Pharmaceutical Society. Two Vols. Cr. 8vo. Vol. I.—Anatomy and Morphology. With 778 Engravings, 7s. 6d.

„ II.—Classification and Physiology.

With 415 Engravings, 10s.

**The Student's Guide to Systematic Botany,** including the Classification of Plants and Descriptive Botany.

By ROBERT BENTLEY, late Emeritus Professor of Botany in King's College and to the Pharmaceutical Society. Fcap. 8vo, with 350 Engravings, 3s. 6d.

**Medicinal Plants :**

Being descriptions, with original figures, of the Principal Plants employed in Medicine, and an account of their Properties and Uses. By Prof. BENTLEY and Dr. H. TRIMEN, F.R.S. In 4 vols., large 8vo, with 306 Coloured Plates, bound in Half Morocco, Gilt Edges, £11 11s.

**Climate and Fevers of India,**

with a series of Cases (Croonian Lectures, 1882). By Sir JOSEPH FAYRER, K.C.S.I., M.D. 8vo, with 17 Temperature Charts, 12s.

*By the same Author.*

**The Natural History and Epi-**

demiology of Cholera: Being the Annual Oration of the Medical Society of London, 1888. 8vo, 3s. 6d.

**A Manual of Family Medicine**

and Hygiene for India. Published under the Authority of the Government of India. By Sir WILLIAM J. MOORE, K.C.I.E., M.D., late Surgeon-General with the Government of Bombay. Sixth Edition. Post 8vo, with 71 Engravings, 12s.

*By the same Author.*

**A Manual of the Diseases of**

India: With a Compendium of Diseases generally. Second Edition. Post 8vo, 10s.

*Also,*

**The Constitutional Require-**

ments for Tropical Climates, &c. Crown 8vo, 4s.

**The Prevention of Disease in**

Tropical and Sub-Tropical Campaigns. (Parkes Memorial Prize for 1886.) By ANDREW DUNCAN, M.D., B.S. Lond., F.R.C.S., Surgeon-Major, Bengal Army. 8vo, 12s. 6d.

**Practical Therapeutics :**

A Manual. By EDWARD J. WARING, C.I.E., M.D., F.R.C.P., and DUDLEY W. BUXTON, M.D., B.S. Lond. Fourth Edition. Crown 8vo, 14s.

*By the same Author.*

**Bazaar Medicines of India,**

And Common Medical Plants: With Full Index of Diseases, indicating their Treatment by these and other Agents procurable throughout India, &c. Fourth Edition. Fcap. 8vo, 5s.

**A Commentary on the Diseases**

of India. By NORMAN CHEVERS, C.I.E., M.D., F.R.C.S., Deputy Surgeon-General H.M. Indian Army. 8vo, 24s.

**Hooper's Physicians' Vade-**

Mecum. A Manual of the Principles and Practice of Physic. Tenth Edition. By W. A. GUY, F.R.C.P., F.R.S., and J. HARLEY, M.D., F.R.C.P. With 118 Engravings. Fcap. 8vo, 12s. 6d.

**The Principles and Practice of Medicine.** (Text-book.) By the late C. HILTON FAGGE, M.D., and P. H. PYE-SMITH, M.D., F.R.S., F.R.C.P., Physician to, and Lecturer on Medicine in, Guy's Hospital. Third Edition. 2 vols. 8vo, cloth, 40s.; Half Leather, 46s.

**Manual of the Practice of Medicine.** By FREDERICK TAYLOR, M.D., F.R.C.P., Physician to, and Lecturer on Medicine at, Guy's Hospital. Fourth Edition. Cr. 8vo, with Engravings, 15s.

**The Practice of Medicine (Student's Guide Series).** By M. CHARTERIS, M.D., Professor of Therapeutics and Materia Medica in the University of Glasgow. Seventh Edition. Fcap. 8vo, with Engravings on Copper and Wood, 10s.

**A Dictionary of Practical Medicine.** By various writers. Edited by JAS. KINGSTON FOWLER, M.A., M.D., F.R.C.P., Physician to Middlesex Hospital and the Hospital for Consumption. 8vo, cloth, 21s.; half calf, 25s.

**A Text-Book of Bacteriology.** By G. M. STERNBERG, M.D., Surgeon-General, U.S. Army. With 9 Plates and 200 Figures in the Text. 8vo, 24s.

**How to Examine the Chest:**

A Practical Guide for the use of Students. By SAMUEL WEST, M.D., F.R.C.P., Assistant Physician to St. Bartholomew's Hospital. Second Edition. With Engravings. Fcap. 8vo, 5s.

**An Atlas of the Pathological Anatomy of the Lungs.** By the late WILSON FOX, M.D., F.R.S., F.R.C.P., Physician to H.M. the Queen. With 45 Plates (mostly Coloured) and Engravings. 4to, half-bound in Calf, 70s.

*By the same Author.*

**A Treatise on Diseases of the Lungs and Pleura.** Edited by SIDNEY COUPLAND, M.D., F.R.C.P., Physician to Middlesex Hospital. Roy. 8vo, with Engravings; also Portrait and Memoir of the Author, 36s.

**The Student's Guide to Diseases of the Chest.** By VINCENT D. HARRIS, M.D. Lond., F.R.C.P., Physician to the City of London Hospital for Diseases of the Chest, Victoria Park. Fcap. 8vo, with 55 Illustrations (some Coloured), 7s. 6d.

**Uric Acid**

as a Factor in the Causation of Disease. By ALEXANDER HAIG, M.D., F.R.C.P., Physician to the Metropolitan Hospital and the Royal Hospital for Children and Women. Third Edition. With 54 Illustrations, 8vo, 12s. 6d.

**Medical Diagnosis** (Student's Guide Series). By SAMUEL FENWICK, M.D., F.R.C.P., Physician to the London Hospital. Seventh Edition. Fcap. 8vo, with 117 Engravings, 7s.

*By the same Author.*

**Outlines of Medical Treatment.** Fourth Edition. Crown 8vo, with 35 Engravings, 10s.

*Also.*

**Clinical Lectures on Some Obscure Diseases of the Abdomen.** Delivered at the London Hospital. 8vo, with Engravings, 7s. 6d.

*Also.*

**The Saliva as a Test for Functional Diseases of the Liver.** Crown 8vo, 2s.

**The Microscope in Medicine.**

By LIONEL S. BEALE, M.B., F.R.S., Physician to King's College Hospital. Fourth Edition. 8vo, with 86 Plates, 21s.

*By the same Author.*

**The Liver.**

With 24 Plates (85 Figures). 8vo, 5s.

*Also.*

**On Slight Ailments:**

And on Treating Disease. Fourth Edition. 8vo, 5s.

**Myxœdema and the Thyroid Gland.** By JOHN D. GIMLETTE, M.R.C.S., L.R.C.P. Crown 8vo, 5s.

**The Physiology of the Carbohydrates; their Application as Food and Relation to Diabetes.** By F. W. PAVY, M.D., LL.D., F.R.S., F.R.C.P., Consulting Physician to Guy's Hospital. Royal 8vo, with Plates and Engravings, 10s. 6d.

**Medical Lectures and Essays.**

By Sir G. JOHNSON, M.D., F.R.C.P., F.R.S. 8vo, with 46 Engravings, 25s.

*By the same Author.*

**An Essay on Asphyxia (Apnœa).** 8vo, 3s.

*Also.*

**History of the Cholera Controversy, with Directions for the Treatment of the Disease.** 8vo, 3s.

*Also.*

**The Pathology of the Contracted Granular Kidney and the Associated Cardio-Arterial Changes.** With 29 Illustrations, 8vo, 4s.

**Bronchial Asthma:**

Its Pathology and Treatment. By J. B. BERKART, M.D., late Physician to the City of London Hospital for Diseases of the Chest. Second Edition, with 7 Plates (35 Figures). 8vo, 10s. 6d.

**Treatment of Some of the Forms of Valvular Disease of the Heart.** By A. E. SANSOM, M.D., F.R.C.P., Physician to the London Hospital. Second Edition. Fcap. 8vo, with 26 Engravings, 4s. 6d.

**The Schott Methods of the Treatment of Chronic Diseases of the Heart,** with an account of the Nauheim Baths and of the Therapeutic Exercises. By W. BEZLY THORNE, M.D., M.R.C.P. Second Edition. 8vo, with Illustrations, 5s.

**Guy's Hospital Reports.**

By the Medical and Surgical Staff. Vol. XXXVI. Third Series. 8vo, 10s. 6d.

**St. Thomas's Hospital Reports.**

By the Medical and Surgical Staff. Vol. XXIII. New Series. 8vo, 8s. 6d.

**Westminster Hospital Reports.**

By the Medical and Surgical Staff. Vol. X. 8vo, 6s.

**Medical Ophthalmoscopy :**

A Manual and Atlas. By W. R. GOWERS, M.D., F.R.C.P., F.R.S. Third Edition. Edited with the assistance of MARCUS GUNN, M.B., F.R.C.S., Surgeon to the Royal London Ophthalmic Hospital. With Coloured Plates and Woodcuts. 8vo, 16s.

*By the same Author.*

**A Manual of Diseases of the Nervous System.**

Vol. I. Diseases of the Nerves and Spinal Cord. Second Edition. Roy. 8vo, with 179 Engravings, 15s.

Vol. II. Diseases of the Brain and Cranial Nerves: General and Functional Diseases of the Nervous System. Second Edition. Roy. 8vo, with 182 Engravings, 20s.

*Also.*

**Clinical Lectures on Diseases of the Nervous System.** 8vo, 7s. 6d.

*Also.*

**Diagnosis of Diseases of the Brain.** Second Edition. 8vo, with Engravings, 7s. 6d.

*Also.*

**Syphilis and the Nervous System.** Being a Revised Reprint of the Lettsomian Lectures for 1890. Delivered before the Medical Society of London. 8vo, 4s.

**The Nervous System,**

Diseases of. By J. A. ORMEROD, M.D., F.R.C.P., Physician to the National Hospital for the Paralysed and Epileptic. With 66 Illustrations. Fcap. 8vo, 8s. 6d.

**Handbook of the Diseases of the Nervous System.** By JAMES ROSS, M.D., F.R.C.P., Professor of Medicine in the Victoria University, and Physician to the Royal Infirmary, Manchester. Roy. 8vo, with 184 Engravings, 18s.

*Also.*

**Aphasia :**

Being a Contribution to the Subject of the Dissolution of Speech from Cerebral Disease. 8vo, with Engravings. 4s. 6d.

**Diseases of the Nervous System.**

Lectures delivered at Guy's Hospital. By SAMUEL WILKS, M.D., F.R.S. Second Edition. 8vo, 18s.

**Stammering :**

Its Causes, Treatment, and Cure. By A. G. BERNARD, M.R.C.S., L.R.C.P. Crown 8vo, 2s.

**Secondary Degenerations of the**

Spinal Cord (Gulstonian Lectures, 1889). By HOWARD H. TOOTH, M.D., F.R.C.P., Assistant Physician to the National Hospital for the Paralysed and Epileptic. With Plates and Engravings. 8vo, 3s. 6d.

**Diseases of the Nervous System.**

Clinical Lectures. By THOMAS BUZZARD, M.D., F.R.C.P., Physician to the National Hospital for the Paralysed and Epileptic. With Engravings, 8vo. 15s.

*By the same Author.*

**Some Forms of Paralysis from**

Peripheral Neuritis: of Gouty, Alcoholic, Diphtheritic, and other origin. Crown 8vo, 5s.

*Also.*

**On the Simulation of Hysteria**

by Organic Disease of the Nervous System. Crown 8vo, 4s. 6d.

**Gout in its Clinical Aspects.**

By J. MORTIMER GRANVILLE, M.D. Crown 8vo, 6s.

**Diseases of the Liver :**

With and without Jaundice. By GEORGE HARLEY, M.D., F.R.C.P., F.R.S. 8vo, with 2 Plates and 36 Engravings, 21s.

**Rheumatic Diseases,**

(Differentiation in). By HUGH LANE, Surgeon to the Royal Mineral Water Hospital, Bath, and Hon. Medical Officer to the Royal United Hospital, Bath. Second Edition, much Enlarged, with 8 Plates. Crown 8vo, 3s. 6d.

**Diseases of the Abdomen,**

Comprising those of the Stomach and other parts of the Alimentary Canal, Oesophagus, Cæcum, Intestines, and Peritoneum. By S. O. HABERSHON, M.D., F.R.C.P. Fourth Edition. 8vo, with 5 Plates, 21s.

**On Gallstones, or Cholelithiasis.**

By E. M. BROCKBANK, M.D. Vict., M.R.C.P. Lond., late Resident Medical Officer at the Manchester Royal Infirmary and the Birmingham General Hospital. Crown 8vo, 7s.

**Headaches :**

Their Nature, Causes, and Treatment. By W. H. DAY, M.D., Physician to the Samaritan Hospital. Fourth Edition. Crown 8vo, with Engravings, 7s. 6d.

**Health Resorts at Home and**

**Abroad.** By M. CHARTERIS, M.D., Professor of Therapeutics and Materia Medica in Glasgow University. Second Edition. Crown 8vo, with Map, 5s. 6d.

**The Mineral Waters of France**

And its Wintering Stations (Medical Guide to). With a Special Map. By A. VINTRAS, M.D., Physician to the French Embassy, and to the French Hospital, London. Second Edition. Crown 8vo, 8s.

**Canary Islands**

Health Resorts, in their Climatological and Medical Aspects. By J. CLEASBY TAYLOR, M.D., M.R.C.S., Las Palmas. 8vo, with Maps, 3s. 6d.

**Homburg Spa.**

An Introduction to its Waters and their use. By Dr. ARNOLD SCHELIG. Crown 8vo, with Synoptical Table, 2s. 6d.

**Illustrated Ambulance Lectures :**

To which is added a NURSING LECTURE. By JOHN M. H. MARTIN, M.D., F.R.C.S., Honorary Surgeon to the Blackburn Infirmary. Fourth Edition. Crown 8vo, with 60 Engravings, 2s.

**Surgery: its Theory and Prac-**

**tice.** By WILLIAM J. WALSHAM, F.R.C.S., Senior Assistant Surgeon to, and Lecturer on Anatomy at, St. Bartholomew's Hospital. Fifth Edition. Crown 8vo, with 380 Engravings, 12s. 6d.

**Surgical Emergencies :**

Together with the Emergencies attendant on Parturition and the Treatment of Poisoning. By PAUL SWAIN, F.R.C.S., Surgeon to the South Devon and East Cornwall Hospital. Fifth Edition. Crown 8vo, with 149 Engravings, 6s.

**Operations on the Brain (A**

**Guide to).** By ALEC FRASER, Professor of Anatomy, Royal College of Surgeons in Ireland. Illustrated by 42 life-size Plates in Autotype, and 2 Woodcuts in the text. Folio, 63s.

**A Course of Operative Surgery.**

By CHRISTOPHER HEATH, Surgeon to University College Hospital. Second Edition. With 20 coloured Plates (180 figures) from Nature, by M. LÉVEILLÉ, and several Woodcuts. Large 8vo, 30s.

*By the same Author.*

**The Student's Guide to Surgical**

**Diagnosis.** Second Edition. Fcap. 8vo, 6s. 6d.

*Also.*

**Manual of Minor Surgery and**

**Bandaging.** For the use of House-Surgeons, Dressers, and Junior Practitioners. Tenth Edition. Fcap. 8vo, with 158 Engravings, 6s.

*Also.*

**Injuries and Diseases of the**

**Jaws.** Fourth Edition. By HENRY PERCY DEAN, M.S., F.R.C.S., Assistant Surgeon to the London Hospital. 8vo, with 187 Wood Engravings, 14s.

*Also.*

**Lectures on Certain Diseases**

**of the Jaws.** Delivered at the R.C.S., Eng., 1887. 8vo, with 64 Engravings, 2s. 6d.

*Also.*

**Clinical Lectures on Surgical**

**Subjects.** Delivered in University College Hospital. Second Edition, Enlarged. Fcap. 8vo, with 27 Engravings, 6s.

**Surgery.**

By C. W. MANSELL MOULLIN, M.A., M.D., Oxon., F.R.C.S., Surgeon and Lecturer on Physiology to the London Hospital. Large 8vo, with 497 Engravings, 34s.

**The Practice of Surgery :**

A Manual. By THOMAS BRYANT, Consulting Surgeon to Guy's Hospital. Fourth Edition. 2 vols. crown 8vo, with 750 Engravings (many being coloured), and including 6 chromo plates, 32s.

*By the same Author.*

**On Tension: Inflammation of**

**Bone, and Head Injuries.** Hunterian Lectures, 1888. 8vo, 6s.

**The Surgeon's Vade-Mecum :**

A Manual of Modern Surgery. By R. DRUITT, F.R.C.S. Twelfth Edition. By STANLEY BOYD, M.B., F.R.C.S. Assistant Surgeon and Pathologist to Charing Cross Hospital. Crown 8vo, with 373 Engravings, 16s.

**Diseases of Bones and Joints.**

By CHARLES MACNAMARA, F.R.C.S., Surgeon to, and Lecturer on Surgery at, the Westminster Hospital. 8vo, with Plates and Engravings, 12s.

**The Operations of Surgery :**

Intended for Use on the Dead and Living Subject alike. By W. H. A. JACOBSON, M.A., M.B., M.Ch. Oxon., F.R.C.S., Assistant Surgeon to, and Lecturer on Anatomy at, Guy's Hospital. Third Edition. 8vo, with many Illustrations. *[In the press.]*

**On Anchylosis.**

By BERNARD E. BRODHURST, F.R.C.S., Surgeon to the Royal Orthopædic Hospital. Fourth Edition. 8vo, with Engravings, 5s.

*By the same Author.*

**Curvatures and Disease of the Spine.** Fourth Edition. 8vo, with Engravings, 7s. 6d.

*Also.*

**Talipes Equino-Varus, or Club-foot.** 8vo, with Engravings, 3s. 6d.

**Surgical Pathology and Morbid Anatomy.** By ANTHONY A. BOWLBY, F.R.C.S., Assistant Surgeon to St. Bartholomew's Hospital. Third Edition. Crown 8vo, with 183 Engravings, 10s. 6d.

*By the same Author.*

**Injuries and Diseases of Nerves and their Surgical Treatment.** 8vo, with 20 Plates, 14s.

**Illustrations of Clinical Surgery.**

By JONATHAN HUTCHINSON, F.R.S., Senior Surgeon to the London Hospital. In fasciculi. 6s. 6d. each. Fasc. I. to X. bound, with Appendix and Index, £3 10s. Fasc. XI. to XXIII. bound, with Index, £4 10s.

**Clubfoot :**

Its Causes, Pathology, and Treatment. By WM. ADAMS, F.R.C.S., Consulting Surgeon to the Great Northern and other Hospitals. Second Edition. 8vo, with 106 Engravings and 6 Lithographic Plates, 15s.

*By the same Author.*

**Lateral and other Forms of Curvature of the Spine: Their Pathology and Treatment.** Second Edition. 8vo, with 5 Lithographic Plates and 72 Wood Engravings, 10s. 6d.

*Also.*

**Contraction of the Fingers :**

(Dupuytren's and Congenital Contractions), their Treatment by Subcutaneous Divisions of the Fascia, and Immediate Extension. Also on Hammer Toe ; its Curability by Subcutaneous Division. And on The Obliteration of Depressed Cicatrices by a Subcutaneous Operation. 8vo, with 8 Plates and 31 Engravings, 6s. 6d.

**Short Manual of Orthopædy.**

By HEATHER BIGG, F.R.C.S. Ed. Part I. Deformities and Deficiencies of the Head and Neck. 8vo. 2s. 6d.

**Face and Foot Deformities.**

By FREDERICK CHURCHILL, C.M. 8vo, with Plates and Illustrations, 10s. 6d.

**The Human Foot :**

Its Form and Structure, Functions and Clothing. By THOMAS S. ELLIS, Consulting Surgeon to the Gloucester Infirmary. With 7 Plates and Engravings (50 Figures). 8vo, 7s. 6d.

**Royal London Ophthalmic Hospital Reports.** By the Medical and Surgical Staff. Vol. XIII., Part 4. 8vo, 5s.

**Ophthalmological Society**

of the United Kingdom. Transactions, Vol. XV. 8vo, 12s. 6d.

**The Diseases of the Eye**

(Student's Guide Series). By EDWARD NETTLESHIP, F.R.C.S., Ophthalmic Surgeon to St. Thomas's Hospital. Fifth Edition. Fcap. 8vo, with 164 Engravings and a Coloured Plate illustrating Colour-Blindness, 7s. 6d.

**Diseases and Refraction of the**

**Eye.** By N. C. MACNAMARA, F.R.C.S., Surgeon to Westminster Hospital, and GUSTAVUS HARTRIDGE, F.R.C.S., Surgeon to the Royal Westminster Ophthalmic Hospital. Fifth Edition. Crown 8vo, with Plate, 156 Engravings, also Test-types, 10s. 6d.

**Diseases of the Eye : a Practical**

**Handbook for General Practitioners and Students.** By CECIL EDWARD SHAW, M.D., M.Ch., Ophthalmic Surgeon to the Ulster Hospital for Children and Women, Belfast. With a Test-Card for Colour-Blindness. Crown 8vo, 3s. 6d.

**On Diseases and Injuries of the**

**Eye: A Course of Systematic and Clinical Lectures to Students and Medical Practitioners.** By J. R. WOLFE, M.D., F.R.C.S.E., Lecturer on Ophthalmic Medicine and Surgery in Anderson's College, Glasgow. With 10 Coloured Plates and 157 Wood Engravings. 8vo, £1 1s.

**Normal and Pathological His-**

**tology of the Human Eye and Eyelids.** By C. FRED. POLLOCK, M.D., F.R.C.S. and F.R.S.E., Surgeon for Diseases of the Eye to Anderson's College Dispensary, Glasgow. Crown 8vo, with 100 Plates (230 drawings), 15s.

**Refraction of the Eye :**

A Manual for Students. By GUSTAVUS HARTRIDGE, F.R.C.S., Surgeon to the Royal Westminster Ophthalmic Hospital. Eighth Edition. Crown 8vo, with 100 Illustrations, also Test-types, &c., 6s.

*By the same Author.*

**The Ophthalmoscope. A Manual**

for Students. Second Edition. Crown 8vo, with 67 Illustrations and 4 Plates. 4s. 6d.

**Methods of Operating for Cataract and Secondary Impairments of Vision, with the results of 500 cases.**

By G. H. FINK, Surgeon-Captain in H.M. Indian Medical Service. Crown 8vo, with 15 Engravings, 5s.

**Atlas of Ophthalmoscopy.**

Composed of 12 Chromo-lithographic Plates (59 Figures drawn from nature) and Explanatory Text. By RICHARD LIEBREICH, M.R.C.S. Translated by H. ROSBOROUGH SWANZY, M.B. Third Edition, 4to, 40s.

**Glaucoma :**

Its Pathology and Treatment. By PRIESTLEY SMITH, Ophthalmic Surgeon to, and Clinical Lecturer on Ophthalmology at, the Queen's Hospital, Birmingham. 8vo, with 64 Engravings and 12 Zinco-photographs, 7s. 6d.

**Eye-strain**

(commonly called Asthenopia). By ERNEST CLARKE, M.D., B.S. Lond., Surgeon to the Central London Ophthalmic Hospital, Surgeon and Ophthalmic Surgeon to the Miller Hospital. 8vo, with 22 Illustrations, 5s.

**Diseases of the Eye :**

A Handbook of Ophthalmic Practice for Students and Practitioners. By G. E. DE SCHWEINITZ, M.D., Professor of Diseases of the Eye in the Philadelphia Polyclinic. With 216 Illustrations, and 2 Chromo-Lithographic Plates. 8vo, 18s.

**Diseases and Injuries of the Ear.**

By Sir WILLIAM B. DALBY, F.R.C.S., M.B., Consulting Aural Surgeon to St. George's Hospital. Fourth Edition. Crown 8vo, with 8 Coloured Plates and 38 Wood Engravings. 10s. 6d.

*By the same Author.*

**Short Contributions to Aural**

Surgery, between 1875 and 1896. Third Edition. 8vo, with Engravings, 5s.

**Diseases of the Ear,**

Including the Anatomy and Physiology of the Organ, together with the Treatment of the Affections of the Nose and Pharynx which conduce to Aural Disease (a Treatise). By T. MARK HOVELL, F.R.C.S.E., M.R.C.S., Aural Surgeon to the London Hospital, and Lecturer on Diseases of the Throat in the College, &c. 8vo, with 122 Engravings, 18s.

**Hinton on Ophthalmic Out-Patient**

Practice. By CHARLES HIGGINS, Ophthalmic Surgeon to Guy's Hospital. Third Edition. Fcap. 8vo, 3s.

**A System of Dental Surgery.**

By Sir JOHN TOMES, F.R.S., and C. S. TOMES, M.A., F.R.S. Third Edition. Crown 8vo, with 292 Engravings, 15s.

**Dental Anatomy, Human and**

Comparative: A Manual. By CHARLES S. TOMES, M.A., F.R.S. Fourth Edition. Crown 8vo, with 235 Engravings, 12s. 6d.

**A Manual of Nitrous Oxide**

Anæsthesia, for the use of Students and General Practitioners. By J. FREDERICK W. SILK, M.D. Lond., M.R.C.S., Anæsthetist to the Royal Free Hospital, Dental School of Guy's Hospital, and National Epileptic Hospital. 8vo, with 26 Engravings, 5s.

**A Practical Treatise on Mechanical**

Dentistry. By JOSEPH RICHARDSON, M.D., D.D.S. Sixth Edition revised and Edited by GEORGE W. WARREN, D.D.S. Roy. 8vo, with 600 Engravings, 21s.

**Notes on Dental Practice.**

By HENRY C. QUINBY, L.D.S.I., President-Elect of the British Dental Association. Second Edition. 8vo, with 92 Illustrations, 8s.

**Papers on Dermatology.**

By E. D. MAPOTHER, M.D., Ex-Pres. R.C.S.I. 8vo, 3s. 6d.

**Atlas of Skin Diseases.**

By TILBURY FOX, M.D., F.R.C.P. With 72 Coloured Plates. Royal 4to, half morocco, £6 6s.

**Diseases of the Skin :**

A Practical Treatise for the Use of Students and Practitioners. By J. N. HYDE, A.M., M.D., Professor of Skin and Venereal Diseases, Rush Medical College, Chicago. Second Edition. 8vo, with 2 Coloured Plates and 96 Engravings, 20s.

**A Handbook on Leprosy.**

By S. P. IMPEY, M.D., M.C., late Chief and Medical Superintendent, Robben Island Leper and Lunatic Asylums, Cape Colony. With 38 Plates and Map, 8vo, 12s.

**Leprosy in British Guiana.**

By JOHN D. HILLIS, F.R.C.S., M.R.I.A., late Medical Superintendent of the Leper Asylum, British Guiana. Imp. 8vo, with 22 Lithographic Coloured Plates and Wood Engravings, £1 11s. 6d.

**Diseases of the Skin**

(Introduction to the Study of). By P. H. PYE-SMITH, M.D., F.R.S., F.R.C.P., Physician to, and Lecturer on Medicine in, Guy's Hospital. Crown 8vo, with 26 Engravings. 7s. 6d.

**Sarcoma and Carcinoma :**

Their Pathology, Diagnosis, and Treatment. By HENRY T. BUTLIN, F.R.C.S., Assistant Surgeon to St. Bartholomew's Hospital. 8vo, with 4 Plates, 8s.

*By the same Author.*

**Malignant Disease of the Larynx (Sarcoma and Carcinoma).** 8vo, with 5 Engravings, 5s.

*Also.*

**Operative Surgery of Malignant Disease.** 8vo, 14s.

**On Cancer :**

Its Allies, and other Tumours; their Medical and Surgical Treatment. By F. A. PURCELL, M.D., M.C., Surgeon to the Cancer Hospital, Brompton. 8vo, with 21 Engravings, 10s. 6d.

**Cancers and the Cancer Process: a Treatise, Practical and Theoretic.** By HERBERT L. SNOW, M.D., Surgeon to the Cancer Hospital, Brompton. 8vo, with 15 Lithographic Plates. 15s.

*By the same Author.*

**The Re-appearance (Recurrence) of Cancer after apparent Extirpation.** 8vo, 5s. 6d.

*Also,*

**The Palliative Treatment of Incurable Cancer.** Crown 8vo, 2s. 6d.

**Cancerous Affections of the Skin.** (Epithelioma and Rodent Ulcer.) By GEORGE THIN, M.D. Post 8vo, with 8 Engravings, 5s.

*By the same Author.*

**Pathology and Treatment of Ringworm.** 8vo, with 21 Engravings, 5s.

**Diagnosis and Treatment of Syphilis.** By TOM ROBINSON, M.D., Physician to St. John's Hospital for Diseases of the Skin. Crown 8vo, 3s. 6d.

*By the same Author.*

**Eczema: its Etiology, Pathology, and Treatment.** Crown 8vo, 3s. 6d.

*Also.*

**Illustrations of Diseases of the Skin and Syphilis, with Remarks.** Fasc. I. with 3 Plates. Imp. 4to, 5s.

By SIR HENRY THOMPSON, F.R.C.S.

**Diseases of the Urinary Organs.** Clinical Lectures. Eighth Edition. 8vo, with 121 Engravings, 10s. 6d.

**Diseases of the Prostate :**

Their Pathology and Treatment. Sixth Edition. 8vo, with 39 Engravings, 6s.

**Surgery of the Urinary Organs.**

Some Important Points connected therewith. Lectures delivered in the R.C.S. 8vo, with 44 Engravings. Student's Edition, 2s. 6d.

**Practical Lithotomy and Lithotrity; or, An Inquiry into the Best Modes of Removing Stone from the Bladder.** Third Edition. 8vo, with 87 Engravings, 10s.

**The Preventive Treatment of Calculous Disease, and the Use of Solvent Remedies.** Third Edition. Crown 8vo, 2s. 6d.

**Tumours of the Bladder :**

Their Nature, Symptoms, and Surgical Treatment. 8vo, with numerous Illustrations, 5s.

**Stricture of the Urethra, and Urinary Fistulæ: their Pathology and Treatment.** Fourth Edition. 8vo, with 74 Engravings, 6s.

**The Suprapubic Operation of Opening the Bladder for the Stone and for Tumours.** 8vo, with 14 Engravings, 3s. 6d.

**Electric Illumination of the Bladder and Urethra, as a Means of Diagnosis of Obscure Vesico-Urethral Diseases.** By E. HURRY FENWICK, F.R.C.S., Surgeon to London Hospital and St. Peter's Hospital for Stone. Second Edition. 8vo, with 54 Engravings, 6s. 6d.

*By the same Author.*

**The Cardinal Symptoms of Urinary Diseases: their Diagnostic Significance and Treatment.** 8vo, with 36 Illustrations. 8s. 6d.

**Atlas of Electric Cystoscopy.**

By Dr. EMIL BURCKHARDT, late of the Surgical Clinique of the University of Bâle, and E. HURRY FENWICK, F.R.C.S., Surgeon to the London Hospital and St. Peter's Hospital for Stone. Royal 8vo, with 34 Coloured Plates, embracing 83 Figures. 21s.

**Lectures on the Surgical Disorders of the Urinary Organs.** By REGINALD HARRISON, F.R.C.S., Surgeon to St. Peter's Hospital. Fourth Edition. 8vo, with 156 Engravings, 16s.

**Chemistry of Urine ;**

A Practical Guide to the Analytical Examination of Diabetic, Albuminous, and Gouty Urine. By ALFRED H. ALLEN, F.I.C., F.C.S. With Engravings, 8vo, 7s. 6d.

**Clinical Chemistry of Urine**

(Outlines of the). By C. A. MAC MUNN, M.A., M.D. 8vo, with 64 Engravings and Plate of Spectra, 9s.

**Urinary and Renal Derangements and Calculous Disorders.**

By LIONEL S. BEALE, F.R.C.P., F.R.S., Physician to King's College Hospital. 8vo, 5s.

**Male Organs of Generation**

(Diseases of). By W. H. A. JACOBSON, M.Ch. Oxon., F.R.C.S., Assistant Surgeon to Guy's Hospital. 8vo, with 88 Engravings. 22s.

**The Surgical Diseases of the**

Genito - Urinary Organs, including Syphilis. By E. L. KEYES, M.D., Professor in Bellevue Hospital Medical College, New York (a revision of VAN BUREN and KEYES' Text-book). Roy. 8vo, with 114 Engravings, 21s.

**Diseases of the Rectum and**

Anus. By ALFRED COOPER, F.R.C.S., Senior Surgeon to the St. Mark's Hospital for Fistula ; and F. SWINFORD EDWARDS, F.R.C.S., Senior Assistant Surgeon to St. Mark's Hospital. Second Edition, with Illustrations. 8vo, 12s.

**Diseases of the Rectum and**

Anus. By HARRISON CRIPPS, F.R.C.S., Assistant Surgeon to St. Bartholomew's Hospital, &c. Second Edition. 8vo, with 13 Lithographic Plates and numerous Wood Engravings, 12s. 6d.

*By the same Author.*

**Cancer of the Rectum.**

Especially considered with regard to its Surgical Treatment. Jacksonian Prize Essay. 8vo, with 13 Plates and several Wood Engravings, 6s.

*Also.*

**The Passage of Air and Fæces from the Urethra.** 8vo, 3s. 6d.**Syphilis**

By ALFRED COOPER, F.R.C.S., Senior Surgeon to St. Mark's Hospital for Fistula. Second Edition. Edited by EDWARD COTTERELL, F.R.C.S., Surgeon (out-patients) to the London Lock Hospital. 8vo, with 24 Full-page Plates (12 coloured), 18s.

**A Medical Vocabulary :**

An Explanation of all Terms and Phrases used in the various Departments of Medical Science and Practice, their Derivation, Meaning, Application, and Pronunciation. By R. G. MAYNE, M.D., LL.D. Sixth Edition by W. W. WAGSTAFFE, B.A., F.R.C.S. Crown 8vo, 10s. 6d.

**A Short Dictionary of Medical**

Terms. Being an Abridgment of Mayne's Vocabulary. 64mo, 2s. 6d.

**Dunghlison's Dictionary of**

Medical Science : Containing a full Explanation of its various Subjects and Terms, with their Pronunciation, Accentuation, and Derivation. Twenty-first Edition. By RICHARD J. DUNGLISON, A.M., M.D. Royal 8vo, 30s.

**Terminologia Medica Poly-**

glotta : a Concise International Dictionary of Medical Terms (French, Latin, English, German, Italian, Spanish, and Russian). By THEODORE MAXWELL, M.D., B.Sc., F.R.C.S. Edin. Royal 8vo, 16s.

**A German-English Dictionary**

of Medical Terms. By FREDERICK TREVES, F.R.C.S., Surgeon to the London Hospital ; and HUGO LANG, B.A. Crown 8vo, half-Persian calf, 12s.

**Chemistry,**

Inorganic and Organic. With Experiments. By CHARLES L. BLOXAM. Eighth Edition, by JOHN MILLAR THOMSON, Professor of Chemistry in King's College, London, and ARTHUR G. BLOXAM, Head of the Chemistry Department, The Goldsmiths' Institute, New Cross. 8vo, with nearly 300 Illustrations.

*By the same Author.*

**Laboratory Teaching ;**

Or, Progressive Exercises in Practical Chemistry. Sixth Edition. By ARTHUR G. BLOXAM. Crown 8vo, with 80 Engravings, 6s. 6d.

**Watts' Manual of Chemistry,**

Theoretical and Practical. By WILLIAM A. TILDEN, D.Sc., F.R.S., Professor of Chemistry in the Normal School of Science, South Kensington.

PHYSICAL AND INORGANIC CHEMISTRY. Second Edition. Crown 8vo, with Coloured Plate of Spectra, and 122 Wood Engravings, 8s. 6d.

CHEMISTRY OF CARBON COMPOUNDS ; or, ORGANIC CHEMISTRY. Second Edition. Crown 8vo, with Engravings, 10s.



**Practical Chemistry**

And Qualitative Analysis. By FRANK CLOWES, D.Sc. Lond., Professor of Chemistry in the University College, Nottingham. Sixth Edition. Post 8vo, with 84 Engravings and Frontispiece, 8s. 6d.

**Quantitative Analysis.**

By FRANK CLOWES, D.Sc. Lond., Professor of Chemistry in the University College, Nottingham, and J. BERNARD COLEMAN, Assoc. R. C. Sci. Dublin; Professor of Chemistry, South-West London Polytechnic. Third Edition. Post 8vo, with 106 Engravings, 9s.

*By the same Authors.*

**Elementary Quantitative Analysis.** Post 8vo, with 62 Engravings, 4s. 6d.

*Also.*

**Elementary Practical Chemistry and Qualitative Analysis.** Post 8vo, with 54 Engravings, 3s. 6d.

*Also.*

**Elementary Qualitative Analysis.** With 40 Engravings. Post 8vo, 2s. 6d.

**Qualitative Analysis.**

By R. FRESENIUS. Translated by CHARLES E. GROVES, F.R.S. Tenth Edition. 8vo, with Coloured Plate of Spectra and 46 Engravings, 15s.

*By the same Author.*

**Quantitative Analysis.**

Seventh Edition.

Vol. I., Translated by A. VACHER. 8vo, with 106 Engravings, 15s.

Vol. II., Parts I to 3, Translated by C. E. GROVES, F.R.S. 8vo, with Engravings, 2s. 6d. each.

**Inorganic Chemistry.**

By EDWARD FRANKLAND, Ph.D., D.C.L., LL.D., F.R.S., and FRANCIS R. JAPP, M.A., Ph.D., F.I.C., F.R.S., Professor of Chemistry in the University of Aberdeen. 8vo, with numerous Illustrations on Stone and Wood, 24s.

**Inorganic Chemistry**

(A System of). By WILLIAM RAMSAY, Ph.D., F.R.S., Professor of Chemistry in University College, London. 8vo, with Engravings, 15s.

*By the same Author.*

**Elementary Systematic Chemistry for the Use of Schools and Colleges.** With Engravings. Crown 8vo, 4s. 6d.; Interleaved, 5s. 6d.

**Valentin's Qualitative Chemical**

**Analysis.** Eighth Edition. By W. R. HODGKINSON, Ph.D., F.R.S.E., Professor of Chemistry and Physics in the Royal Military Academy, and Artillery College, Woolwich. 8vo, with Engravings and Map of Spectra, 8s. 6d.

**Analytical Chemistry.**

Notes for Students in Medicine. By ALBERT J. BERNAVS, Ph.D., F.C.S., F.I.C. Third Edition. Cr. 8vo, 4s. 6d.

**Volumetric Analysis:**

(A Systematic Handbook of); or the Quantitative Estimation of Chemical Substances by Measure, applied to Liquids, Solids, and Gases. By FRANCIS SUTTON, F.C.S., F.I.C., Public Analyst for the County of Norfolk. Seventh Edition. 8vo, with 112 Engravings, 18s. 6d.

**Commercial Organic Analysis:**

A Treatise on the Properties, Modes of Assaying, Proximate Analytical Examination, &c., of the various Organic Chemicals and Products employed in the Arts, Manufactures, Medicine, &c. By ALFRED H. ALLEN, F.I.C., F.C.S., Public Analyst for the West Riding of Yorkshire, the Northern Division of Derbyshire, &c.

Vol. I.—Alcohols, Neutral Alcoholic Derivatives, Sugars, Starch and its Isomers, Vegetable Acids, &c. With Illustrations. Third Edition. 8vo. *[Preparing.]*

Vol. II.—Fixed Oils and Fats, Hydrocarbons, Phenols, &c. With Illustrations. Third Edition. 8vo. *[Preparing.]*

Vol. III.—Part I. Aromatic Acids, Tannins, Dyes, and Colouring Matters. Third Edition, 8vo. *[Preparing.]*

Vol. III.—Part II. Anines and Ammonium Bases, Hydrazines, Bases from Tar, Vegetable Alkaloids. Second Edition. 8vo, 18s.

Vol. III.—Part III. Vegetable Alkaloids (concluded), Non-Basic Vegetable Bitter Principles, Animal Bases, Animal Acids, Cyanogen and its Derivatives.

**Cooley's Cyclopædia**

of Practical Receipts, and Collateral Information in the Arts, Manufactures, Professions, and Trades: Including Medicine, Pharmacy, Hygiene and Domestic Economy. Seventh Edition, by W. NORTH, M.A. Camb., F.C.S. 2 Vols., Roy. 8vo, with 371 Engravings, 42s.

**Chemical Technology:**

A Manual. By RUDOLF VON WAGNER. Translated and Edited by WILLIAM CROOKES, F.R.S., from the Thirteenth Enlarged German Edition as remodelled by Dr. FERDINAND FISCHER. 8vo, with 596 Engravings, 32s.

**Chemical Technology ;**

Or, Chemistry in its Applications to Arts and Manufactures. Edited by CHARLES E. GROVES, F.R.S., and WILLIAM THORP, B.Sc.

Vol. I.—FUEL AND ITS APPLICATIONS. By E. J. MILLS, D.Sc., F.R.S., and F. J. ROWAN, C.E. Royal 8vo, with 606 Engravings, 30s.

Vol. II.—LIGHTING BY CANDLES AND OIL. By W. Y. DENT, J. MCARTHUR, L. FIELD and F. A. FIELD, BOVERTON REDWOOD, and D. A. LOUIS. Royal 8vo, with 358 Engravings and Map, 20s.

Vol. III.—GAS AND ELECTRICITY: *[In the press.]*

**Technological Handbooks.**

EDITED BY JOHN GARDNER, F.I.C., F.C.S., and JAMES CAMERON, F.I.C.

BREWING, DISTILLING, AND WINE MANUFACTURE. Crown 8vo, with Engravings, 6s. 6d.

BLEACHING, DYEING, AND CALICO PRINTING. With Formulæ. Crown 8vo, with Engravings, 5s.

OILS, RESINS, AND VARNISHES. Crown 8vo, with Engravings. 7s. 6d.

SOAPS AND CANDLES. Crown 8vo, with 54 Engravings, 7s.

**The Microscope and its Revelations.**

By the late WILLIAM B. CARPENTER, C.B., M.D., LL.D., F.R.S. Seventh Edition, by the Rev. W. H. DALLINGER, LL.D., F.R.S. With 21 Plates and 800 Wood Engravings. 8vo, 26s. Half Calf, 30s.

**The Quarterly Journal of Microscopical Science.**

Edited by E. RAY LANKESTER, M.A., LL.D., F.R.S.; with the co-operation of ADAM SEDGWICK, M.A., F.R.S., and W. F. R. WELDON, M.A., F.R.S. Each Number, 10s.

**Methods and Formulæ**

Used in the Preparation of Animal and Vegetable Tissues for Microscopical Examination, including the Staining of Bacteria. By PETER WYATT SQUIRE, F.L.S. Crown 8vo, 3s. 6d.

**The Microtometist's Vade-Mecum:**

A Handbook of the Methods of Microscopic Anatomy. By ARTHUR BOLLES LEE, Assistant in the Russian Laboratory of Zoology at Villefranche-sur-mer (Nice). Fourth Edition. 8vo, 15s.

**Photo-Micrography**

(Guide to the Science of). By EDWARD C. BOUSFIELD, L.R.C.P. Lond. 8vo, with 34 Engravings and Frontispiece, 6s.

**An Introduction to Physical Measurements,**

with Appendices on Absolute Electrical Measurements, &c. By Dr. F. KOHLRAUSCH, Professor at the University of Strassburg. Third Edition, translated from the Seventh German Edition, by THOMAS HUTCHINSON WALLER, B.A., B.Sc., and HENRY RICHARDSON PROCTER, F.I.C., F.C.S. 8vo, with 91 Illustrations, 12s. 6d.

**Tuson's Veterinary Pharmacopœia,**

including the Outlines of Materia Medica and Therapeutics. Fifth Edition. Edited by JAMES BAYNE, F.C.S., Professor of Chemistry and Toxicology in the Royal Veterinary College. Crown 8vo, 7s. 6d.

**The Principles and Practice of**

**Veterinary Medicine.** By WILLIAM WILLIAMS, F.R.C.V.S., F.R.S.E., Principal, and Professor of Veterinary Medicine and Surgery at the New Veterinary College, Edinburgh. Seventh Edition. 8vo, with several Coloured Plates and Woodcuts, 30s.

*By the same Author.*

**The Principles and Practice**

**of Veterinary Surgery.** Eighth Edition. 8vo, with 9 Plates and 147 Woodcuts, 30s.

**The Veterinarian's Pocket Re-**

**membrancer:** being Concise Directions for the Treatment of Urgent or Rare Cases, embracing Semeiology, Diagnosis, Prognosis, Surgery, Therapeutics, Toxicology, Detection of Poisons by their Appropriate Tests, Hygiene, &c. By GEORGE ARMATAGE, M.R.C.V.S. Second Edition. Post 8vo, 3s.

**Chauveau's Comparative Anat-**

**omy of the Domesticated Animals.** Revised and Enlarged, with the Co-operation of S. ARLOING, Director of the Lyons Veterinary School, and Edited by GEORGE FLEMING, C.B., LL.D., F.R.C.V.S., late Principal Veterinary Surgeon of the British Army. Second English Edition. 8vo, with 585 Engravings, 31s. 6d.

- Adams (W.) on Clubfoot, 9  
 — on Contractions of the Fingers, &c., 9  
 — on Curvature of the Spine, 9
- Allen's Chemistry of Urine, 12  
 — Commercial Organic Analysis, 13
- Armatage's Veterinary Pocket Remembrancer, 14
- Barnes (R.) on Obstetric Operations, 3  
 — on Diseases of Women, 3
- Beale (L. S.) on Liver, 6  
 — Microscope in Medicine, 6  
 — Slight Ailments, 6  
 — Urinary and Renal Derangements, 12
- Beale (P. T. B.) on Elementary Biology, 2
- Beasley's Book of Prescriptions, 5  
 — Druggists' General Receipt Book, 5  
 — Pocket Formulary, 5
- Bell on Sterility, 3
- Bellamy's Surgical Anatomy, 1
- Bentley and Trimen's Medicinal Plants, 5
- Bentley's Systematic Botany, 5
- Berkart's Bronchial Asthma, 6
- Bernard on Stammering, 7
- Bernay's Notes on Analytical Chemistry, 1
- Bigg's Short Manual of Orthopædy, 9
- Bloxam's Chemistry, 12  
 — Laboratory Teaching, 12
- Bousfield's Photo-Micrography, 14
- Bowly's Injuries and Diseases of Nerves, 9  
 — Surgical Pathology and Morbid Anatomy, 9
- Brockbank on Gallstones, 8
- Brodhurst's Anchylosis, 9  
 — Curvatures, &c., of the Spine, 9  
 — Talipes Equino-Varus, 9
- Bryant's Practice of Surgery, 8  
 — Tension, Inflammation of Bone, Injuries, &c., 8
- Burckhardt's (E.) and Fenwick's (E. H.) Atlas of  
 Cystoscopy, 11
- Burdett's Hospitals and Asylums of the World, 2
- Butlin's Malignant Disease of the Larynx, 11  
 — Operative Surgery of Malignant Disease, 11  
 — Sarcoma and Carcinoma, 11
- Buzzard's Diseases of the Nervous System, 7  
 — Peripheral Neuritis, 7  
 — Simulation of Hysteria, 7
- Cameron's Oils, Resins, and Varnishes, 14  
 — Soaps and Candles, 14
- Carpenter and Dallinger on the Microscope, 14
- Carpenter's Human Physiology, 2
- Charteris on Health Resorts, 8  
 — Practice of Medicine, 6
- Chauveau's Comparative Anatomy, 14
- Chevers' Diseases of India, 5
- Churchill's Face and Foot Deformities, 9
- Clarke's Eyestrain, 10
- Clouston's Lectures on Mental Diseases, 2
- Clowes and Coleman's Quantitative Analysis, 13  
 — Elementary Analysis, 13
- Clowes' Practical Chemistry, 13
- Cooley's Cyclopædia of Practical Receipts, 13
- Cooper on Syphilis, 12
- Cooper and Edwards' Diseases of the Rectum, 12
- Cripps' (H.) Cancer of the Rectum, 12  
 — Diseases of the Rectum and Anus, 12  
 — Air and Fæces in Urethra, 12
- Cripps' (R. A.) Galenic Pharmacy, 4
- Cullingworth's Manual of Nursing, 4  
 — Short Manual for Monthly Nurses, 4
- Dalby's Diseases and Injuries of the Ear, 10  
 — Short Contributions, 10
- Day on Diseases of Children, 4  
 — on Headaches, 3
- Domville's Manual for Nurses, 4
- Doran's Gynecological Operations, 3
- Druitt's Surgeon's Vade-Mecum, 8
- Duncan (A.) on Prevention of Disease in Tropics, 5
- Duncan (J. M.) on Diseases of Women, 3
- Dunglison's Dictionary of Medical Science, 12
- Ellis's (E.) Diseases of Children, 4
- Ellis's (T. S.) Human Foot, 9
- Fagge's Principles and Practice of Medicine, 6
- Fayer's Climate and Fevers of India, 5  
 — Natural History, &c., of Cholera, 5
- Fenwick (E. H.), Electric Illumination of Bladder, 11  
 — Symptoms of Urinary Diseases, 11
- Fenwick's (S.) Medical Diagnosis, 6  
 — Obscure Diseases of the Abdomen, 6
- Fenwick's (S.) Outlines of Medical Treatment, 6  
 — The Saliva as a Test, 6
- Fink's Operating for Cataract, 10
- Flower's Diagrams of the Nerves, 1
- Fowler's Dictionary of Practical Medicine, 6
- Fox's (T.) Atlas of Skin Diseases, 10
- Fox (Wilson), Atlas of Pathological Anatomy of Lungs, 6  
 — Treatise on Diseases of the Lungs, 6
- Frankland and Japp's Inorganic Chemistry, 13
- Fraser's Operations on the Brain, 8
- Fresenius' Qualitative Analysis, 13  
 — Quantitative Analysis, 13
- Galabin's Diseases of Women, 3  
 — Manual of Midwifery, 3
- Gardner's Bleaching, Dyeing, and Calico Printing, 14  
 — Brewing, Distilling, and Wine Manuf. 14
- Gimlette on Myxœdema, 6
- Godlee's Atlas of Human Anatomy, 1
- Goodhart's Diseases of Children, 4
- Gowers' Diagnosis of Diseases of the Brain, 7  
 — Manual of Diseases of Nervous System, 7  
 — Clinical Lectures, 7  
 — Medical Ophthalmoscopy, 7  
 — Syphilis and the Nervous System, 7
- Granville on Gout, 7
- Green's Manual of Botany, 5
- Groves' and Thorp's Chemical Technology, 14
- Cuy's Hospital Reports, 7
- Habershon's Diseases of the Abdomen, 7
- Haig's Uric Acid, 6
- Harley on Diseases of the Liver, 7
- Harris's (V. D.) Diseases of Chest, 6
- Harrison's Urinary Organs, 11
- Hartridge's Refraction of the Eye, 10  
 — Ophthalmoscope, 10
- Hawthorne's Galenic Preparations of B P, 4
- Heath's Certain Diseases of the Jaws, 8  
 — Clinical Lectures on Surgical Subjects, 8  
 — Injuries and Diseases of the Jaws, 8  
 — Minor Surgery and Bandaging, 8  
 — Operative Surgery, 8  
 — Practical Anatomy, 1  
 — Surgical Diagnosis, 8
- Hellier's Notes on Gynecological Nursing, 4
- Higgins' Ophthalmic Out-patient Practice, 10
- Hill on Cerebral Circulation, 2
- Hillis' Leprosy in British Guiana, 10
- Hirschfeld's Atlas of Central Nervous System, 2
- Holden's Human Osteology,  
 — Landmarks, 1
- Hooper's Physicians' Vade-Mecum, 5
- Hovell's Diseases of the Ear, 10
- Howden's Index Pathologicus, 2
- Hutchinson's Clinical Surgery, 9
- Hyde's Diseases of the Skin, 10
- Hyslop's Mental Physiology, 3
- Impey on Leprosy, 10
- Jacobson's Male Organs of Generation, 12  
 — Operations of Surgery, 9
- Johnson's Asphyxia, 6  
 — Medical Lectures and Essays, 6  
 — Cholera Controversy, 6  
 — Granular Kidney, 6
- Journal of Mental Science, 3
- Keyes' Genito-Urinary Organs and Syphilis, 12
- Kohlrausch's Physical Measurements, 14
- Lancereaux's Atlas of Pathological Anatomy, 2
- Lane's Rheumatic Diseases, 7
- Langdon-Down's Mental Affections of Childhood, 3
- Lee's Microtomists' Vade Mecum, 14
- Lescher's Recent Materia Medica, 4
- Lewis (Bevan) on the Human Brain, 2
- Liebreich's Atlas of Ophthalmoscopy, 10
- MacMunn's Clinical Chemistry of Urine, 12
- Macnamara's Diseases and Refraction of the Eye,  
 — of Bones and Joints, 8
- McNeill's Epidemics and Isolation Hospitals, 2
- Malcolm's Physiology of Death, 4
- Mapother's Papers on Dermatology, 10
- Martin's Ambulance Lectures, 8
- Maxwell's Terminologia Medica Polyglotta, 12
- Mayne's Medical Vocabulary, 12
- Mercier's Lunacy Law, 3  
 — Microscopical Journal, 14
- Mills and Rowan's Fuel and its Applications, 14
- Moore's (N.) Pathological Anatomy of Diseases, 1

[Continued on the next page.]

- Moore's (Sir W. J.) Family Medicine for India, 5  
 Manual of the Diseases of India, 5  
 Tropical Climates, 5
- Morris's Human Anatomy, 1
- Moullin's (Mansell) Surgery, 8
- Nettleship's Diseases of the Eye, 9
- Notter and Firth's Hygiene, 2
- Oliver's Abdominal Tumours, 3  
 Diseases of Women, 3
- Ophthalmic (Royal London) Hospital Reports, 9
- Ophthalmological Society's Transactions, 9
- Ormerod's Diseases of the Nervous System, 7
- Owen's Materia Medica, 4
- Parkes' (E. A.) Practical Hygiene, 2
- Parkes' (L. C.) Elements of Health, 2
- Pavy's Carbohydrates, 6
- Pereira's Selecta à Prescriptis, 4
- Phillips' Materia Medica and Therapeutics, 4
- Pitt-Lewis's Insane and the Law, 3
- Pollock's Histology of the Eye and Eyelids, 9
- Proctor's Practical Pharmacy, 4
- Purcell on Cancer, 11
- Pye-Smith's Diseases of the Skin, 11
- Quinby's Notes on Dental Practice, 10
- Ramsay's Elementary Systematic Chemistry, 13  
 Inorganic Chemistry, 13
- Reynolds' Diseases of Women, 3
- Richardson's Mechanical Dentistry, 10
- Roberts' (D. Lloyd) Practice of Midwifery, 3
- Robinson's (Tom) Eczema, 11  
 Illustrations of Skin Diseases, 11  
 Syphilis, 11
- Ross's Aphasia, 7  
 Diseases of the Nervous System, 7
- Royle and Harley's Materia Medica, 5
- St. Thomas's Hospital Reports, 7
- Sansom's Valvular Disease of the Heart, 7
- Schetelig's Homburg Spa, 8
- Schweinitz's (G. E. de) Diseases of Eye, 10
- Shaw's Diseases of the Eye, 9
- Short Dictionary of Medical Terms, 12
- Silk's Manual of Nitrous Oxide, 10
- Smith's (E.) Clinical Studies, 4  
 Diseases in Children, 4  
 Wasting Diseases of Infants and Children, 4
- Smith's (J. Greig) Abdominal Surgery, 4
- Smith's (Priestley) Glaucoma, 10
- Snow's Cancer and the Cancer Process, 11  
 Palliative Treatment of Cancer, 11  
 Reappearance of Cancer, 11
- Southern's Materia Medica, 5
- Squire's (P.) Companion to the Pharmacopœia, 4
- Squire's (P.) London Hospitals Pharmacopœias, 4  
 Methods and Formulæ, 14
- Starling's Elements of Human Physiology, 2
- Sternberg's Bacteriology, 6
- Stevenson and Murphy's Hygiene, 2
- Sutton's (H. G.), Lectures on Pathology, 1
- Sutton's (J. B.), General Pathology, 1
- Sutton's (F.) Volumetric Analysis, 13
- Swain's Surgical Emergencies, 8
- Swayne's Obstetric Aphorisms, 3
- Taylor's (A. S.) Medical Jurisprudence, 2
- Taylor's (F.) Practice of Medicine, 6
- Taylor's (J. C.), Canary Islands, 8
- Thin's Cancerous Affections of the Skin, 11  
 Pathology and Treatment of Ringworm, 11
- Thomas's Diseases of Women, 3
- Thompson's (Sir H.) Calculous Disease, 11  
 Diseases of the Prostate, 11  
 Diseases of the Urinary Organs, 11  
 Lithotomy and Lithotripsy, 11  
 Stricture of the Urethra, 11  
 Suprapubic Operation, 11  
 Surgery of the Urinary Organs, 11  
 Tumours of the Bladder, 11
- Thorne's Diseases of the Heart, 7
- Tirard's Prescriber's Pharmacopœia, 5
- Tomes' (C. S.) Dental Anatomy, 10
- Tomes' (J. and C. S.) Dental Surgery, 10
- Tooth's Spinal Cord, 7
- Treves and Lang's German-English Dictionary, 12
- Tuke's Dictionary of Psychological Medicine, 3  
 Influence of the Mind upon the Body, 3
- Tuson's Veterinary Pharmacopœia, 14
- Valentin and Hodgkinson's Qualitative Analysis, 13
- Vintras on the Mineral Waters, &c., of France, 8
- Wagner's Chemical Technology, 14
- Walsham's Surgery: its Theory and Practice, 8
- Waring's Indian Bazaar Medicines, 5  
 Practical Therapeutics, 5
- Watts' Manual of Chemistry, 12
- West's (S.) How to Examine the Chest, 6
- Westminster Hospital Report, 7
- White's (Hale) Materia Medica, Pharmacy, &c., 4
- Wilks' Diseases of the Nervous System, 7
- Williams' Veterinary Medicine, 14  
 Surgery, 14
- Wilson's (Sir E.) Anatomists' Vade-Mecum, 1
- Wilson's (G.) Handbook of Hygiene, 2
- Wolfe's Diseases and Injuries of the Eye, 9
- Wynter and Wethered's Practical Pathology, 1
- Year-Book of Pharmacy, 5
- Yeo's (G. F.) Manual of Physiology, 2

*N.B.—J. & A. Churchill's larger Catalogue of about 600 works on Anatomy, Physiology, Hygiene, Midwifery, Materia Medica, Medicine, Surgery, Chemistry, Botany, &c. &c., with a complete Index to their Subjects, for easy reference, will be forwarded post free on application.*

*AMERICA.—J. & A. Churchill being in constant communication with various publishing houses in America are able to conduct negotiations favourable to English Authors.*





RD591

M45

Maylard

Surgery of Alimentary Canal

COLUMBIA UNIVERSITY LIBRARIES (hsl.stx)

**RD 591 M45 C.1**

A treatise on the surgery of the aliment



2002251140

